

# PRICE LIST

RECOMMENDED RETAIL PRICES  
EXCLUDING VAT  
JANUARY 2023

 **SilentGliss**



This price list is intended to give comprehensive price information on all systems and on all components used with them. Its format follows that of the main Silent Gliss catalogue. Accessories usable with any given system should appear underneath that system.

## Index

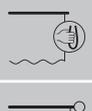
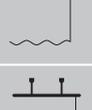
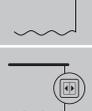
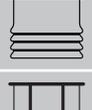
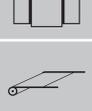
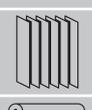
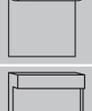
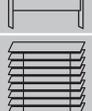
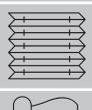
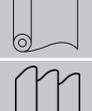
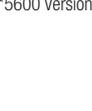
	<b>Hand Operated Curtain Tracks, Picture Hanging</b> SG 1020, SG 1021, SG 1025, SG 1070, SG 1080, SG 1090, SG 1280, SG 6010, SG 6290, SG 6021, SG 6243, SG 6293, SG 6380, SG 6465, SG 6820, SG 6840, SG 6870, SG 6970 Pages: 2-9
	<b>Cord Operated Curtain Tracks, Heavy Duty/Stage Curtain Tracks</b> SG 3000, SG 3840, SG 3870, SG 3900, SG 3970, SG 6370 Pages: 10-13
	<b>Pole Systems</b> SG 7600, SG 7610, SG 7620, SG 7630, SG 7640, SG 7650, SG 7605 Pages: 14-22
	<b>Room Divider Systems, Cubicle, Shower, Safety Device System</b> SG 6100, SG 6103, SG 6650 Pages: 23-24
	<b>Electrically Operated Curtain Tracks</b> SG 5100B, SG 5100R, SG 5100T, SG 5100TC, SG 5600, SG 5800 Pages: 25-27
	<b>Switches, Remote Control and Multiple Operation of Motorised Systems</b> SG 0450, SG 9940, Battery Operated Controls, SMART. Page: 28
	<b>Roman, Austrian, Festoon Blind Systems</b> SG 2120, SG 2305, SG 2345, SG 2350, Made-to-measure Roman Blinds Pages: 29-31
	<b>Sliding Panel Systems</b> SG 2700, SG 2730 Page: 32
	<b>Skylight Systems</b> SG 2190, SG 2195, SG 8600, SG 8640 Page: 33-35
	<b>Vertical Blinds</b> SG 2810, SG 2900, SG 2950 Pages: 36-42
	<b>Roller Blinds</b> SG 4900, SG 4907, SG 4910, SG 4930, SG 4840, SG 4955, SG 4960, SG 4970, SG 4880, Application chart, Fascia pricing tables Pages: 43-57
	<b>Dim-Out Blinds</b> SG 4710, SG 4730, SG 4740, SG 4760, SG 4770, SG 4780 Pages: 58-61
	<b>Venetian Blinds</b> SG 8110 (16mm), SG 8110PC (25mm), SG 8250, SG 8300, SG 8910, SG 8960 Pages: 62-72
	<b>Plissée Pleated Blinds</b> SG 8500 Pages: 73
	<b>Digital Printing/Special Colours (profile/components)</b> Page: 74
	<b>Wave® Standard Curtains</b> Page: 75
	<b>Swiss Pleat® Curtains</b> Page: 76
	<b>Parts Index/Tools &amp; Packaging/Application Chart for switches, remote control and multiple operation of motorised systems/Conditions of Sale</b> Pages: 77-97

## Prices

Prices are maximum recommended Retail Price, not including VAT. Trade discounts applicable vary with product group as detailed below. Each system and item is designated as belonging to one of the following groups:-

**Product Group A** 1020, 1021, 1025, 1070, 1080, 1090, 1280, 2120, 2305, 3000, 3600, 3840, 3870, 3900, 5100B, 5100R, 5100T, 5100TC, 6010, 6021, 6100, 7600, 7605, 7610, 7620, 7630, 7640, 7650\*, 6290, 6243, 6293, 6380, 6465, 6650, 6820, 6840, 6870, 6970 made to measure Roman blinds.

**Product Group C** 0450, 2190, 2195, 2345, 2350, 2700, 2730, 2810, 2900, 2950, 3970, 4710, 4730, 4740, 4760, 4770, 4780, 4930, 4840, 4970, 4880, 4900, 4907, 4910, 4955, 4960, 5600, 5800, 6370, 7650\*, 8110, 8250, 8300, 8500, 8600, 8640, 8910, 8960, 9940, SMART.

Silent Gliss Fabrics, Laminated blinds.

**Product Group E** Tools, Promotional material.

\*5100 Version, Product Group A.

\*5600 Version, Product Group C.

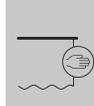

# Hand Operated Curtain Tracks

## SG 1020



Supplied in white. Profile available in 6 metre lengths. Top fix as standard.

27cm std.

## SG 1021



Supplied in satin silver or white. For special colours see below – special order.

## SG 1025



Silver profile available in 5 and 6 metre lengths, white in 6 metre lengths only.

10cm std.

System Prices		Price Ctg.
Specific lengths charged at the nearest 25cm increment above.		A
cm	White £	
125	50.66	
150	54.76	
175	62.43	
200	66.56	
225	74.21	
250	78.31	
275	85.99	
300	90.10	
325	97.75	
350	101.86	
375	109.55	
400	113.65	
425	121.33	
450	125.41	
475	133.09	
500	137.20	
525	144.86	
550	148.96	
575	156.65	
600	160.75	
Prices above are for systems ready-assembled. Substantial savings can be made for self-assembly. Rail can be supplied in full lengths or cut-to-size with accessories separately.		

Rail and Standard Accessories		Price Ctg.
6822 Rail, white in 6m.		A
6824 Endcover white, each, 10, 100.		
3016 Endstop, each, 100.		
3533 Glider Box, 100.		
Self-service sachets, 25 x 25, Euroslat sachet 25		
3534 Glider, in strip form, at 14 per m, outer 1000.		
11236 Clip, 100.		

Optional Accessories		Price Ctg.
(additional charges may apply)		A
3062 Connecting bridge.		
3070 Twist eye endstop, each, 10.		
3071 Screw twist endstop, each, 10.		
3511 Glider, 100, outer, 25,000.		
3548 Retrofit glider, 25, 100, 1000.		
3570 Rotating glider, 10, 100.		
3582 Hook, Box, 100. Self service sachets, 25x25. Outer, 1,000. Outer, 20,000.		
3599 Hook, box 100, outer 25,000.		
10430-10434 Draw Rods, white, black or aluminium.		
11335 Endstop white, silver or black, each, 100.		
Colours		E
Other colours special order - see Page 74.		
Bending		33 1/3%
	Max. trade discount	
Angle bend £35.50 each. Standard radius 27cm.		
Semi-circle or gradual curve £45.50 each.		

Rail and Standard Accessories		Price Ctg.
1021p/1025p Rail, silver available in 5m and 6m or cut-to-size.		A
White available in 6m or cut-to-size.		
3533 Glider at 14 per metre. Box, 100. Self-service sachets, 25 x 25. Outer, 25,000.		
3534 Glider, in strip form, at 14 per metre. Outer, 1,000 gliders,		
6835A Screw, 12mm/1/2" No. 4 round head at 300mm centres, 100.		
3016 Endstop, each, 100.		

System Prices		Price Ctg.
Specific lengths charged at the nearest 25cm increment above.		A
cm	Silver £	White £
125	17.96	29.27
150	21.59	35.16
175	25.16	40.99
200	28.74	46.79
225	32.36	52.66
250	35.96	58.45
275	39.52	64.31
300	43.15	70.21
325	46.76	76.07
350	50.32	81.89
375	53.88	87.77
400	57.54	93.60
425	61.14	99.42
450	64.69	105.24
475	68.32	111.23
500	71.89	117.00
525	75.50	122.84
550	79.14	128.69
575	82.66	134.58
600	86.27	140.40
Above prices are for systems ready-assembled. Substantial savings can be made for self-assembly. Rail can be supplied in full lengths or cut-to-size with accessories separately.		

Optional Accessories		Price Ctg.
(additional charges may apply)		A
3511 Glider, at 16 per metre, 100. Outer, 25,000 gliders.		
3532 Glider. 100. Outer, 5,000.		
3570 Rotating glider, 100.		
3582 Hook, Box, 100. Self-service sachets, 25 x 25. Outer, 1,000. Outer, 20,000.		
3020 Hook. Metal, 100.		
3599 Hook. Box, 100. Self-service sachets, 25 x 25. Outer, 25,000.		
3032 Spring stop, 10, 100.		
3070 Twist eye endstop, each, 10.		
3071 Screw twist endstop, each, 10.		
3562 Standard tape, 100 metres.		
3580 Side mounted glider/hook, 100. Outer, 5,000.		
3571 Hook. Box, 100. Self-service sachets, 25 x 25. Outer, 35,000.		
6835B Screw 24mm/1", 100.		
3548 Retrofit glider, 25, 100, 1000.		
3068A Loop tape, 250 metres.		
10430 - 10434 Draw rods, white, black or aluminium		
Colours		E
Other colours special order - see Page 74.		
Tools		E
80018 Slotting tool		
7809 Filler set at 200cm		
Bending		33 1/3%
	Max. trade discount	
Angle bend £35.50 each. Standard radius 10cm.		

All prices shown exclude VAT

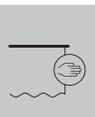

# Hand Operated Curtain Tracks

## SG 1070

Supplied in white. Profile available in 6 metre lengths. Top fix as standard.

12cm std.

## SG 1080

Supplied in satin silver anodised finish, white, black, matt white, antique bronze, anodic grey and charcoal. Silver and white profile available in 5 and 6 metre lengths, other coloured profiles 6m only.

SG 1080 Black available from 1<sup>st</sup> April 2023

10cm std.

System Prices		Price Ctg.
Specific lengths charged at the nearest 25cm increment above.		A
cm	White £	
125	24.58	
150	28.27	
175	32.87	
200	36.57	
225	41.16	
250	44.86	
275	49.46	
300	53.14	
325	57.74	
350	61.43	
375	66.04	
400	69.73	
425	74.32	
450	77.99	
475	82.62	
500	86.31	
525	90.90	
550	94.59	
575	99.21	
600	102.88	

Prices above are for systems ready-assembled. Substantial savings can be made for self-assembly. Rail can be supplied in full lengths or cut-to-size with accessories separately.

Rail and Standard Accessories		Price Ctg.
1071 Rail, white in 6m Lengths.		A
1072 Endcover white, 10, 100.		
3016 Endstop, each, 100.		
3060 Clamp, each, 10, 100.		
3533 Glider Box, 100.		
Self-service sachets, 25 x 25, Euroslot sachet 25.		
3534 Glider, in strip form, at 14 per m, outer 1000.		

All prices shown exclude VAT

Optional Accessories		Price Ctg.
(additional charges may apply)		A
3070 Twist eye endstop, each, 10.		
3062 Connecting bridge, each.		
3511 Glider, 100, outer, 25,000.		
3548 Retrofit glider, 25, 100, 1000.		
3570 Rotating glider, 10, 100.		
3582 Hook, box 100, outer 1,000, outer 20,000.		
3599 Hook, box 100, outer 25,000.		
10430-10434 Draw Rods, white, black or aluminium.		
11335 Endstop white, silver or black, each, 100.		

Colours		Price Ctg.
Other colours special order - see Page 74.		E

Bending		Max. trade discount	33⅓%
Angle bend £35.50 each. Standard radius 12cm.			
Semi-circle or gradual curve £45.50 each.			

System Prices		Price Ctg.
Specific lengths charged at the nearest 25cm increment above.		A
cm	W/S/BL £	
125*	26.60	
150*	31.88	
175*	37.18	
200*	42.48	
225*	47.80	
250*	53.08	
275*	58.43	
300	63.77	
325	69.03	
350	74.41	
375	79.66	
400	84.94	
425	90.28	
450	95.61	
475	100.88	
500	106.22	
525	111.49	
550	116.82	
575	122.13	
600	127.41	

1080p Rail, silver, white, in 5m & 6m, matt white, antique bronze, anodic grey, black and charcoal in 6m.

3533 Glider Box, white, black 100. Self-service sachets, 25 x 25. Outer, 25,000. Euroslot sachet 25.

3534 Glider, white, black in strip form, at 14/m.

18R Screw 25mm/1". No. 8 round head, 100.

3667 Endcover/stop, grey, white, black, matt white, anodic grey, antique bronze, charcoal. each 10, 100. Euroslot sachet 2 (white and grey only).

3630 Universal nylon bracket, white, black at 600mm centres, each 10, 100. Euroslot sachet 2.

System Prices		Price Ctg.
Specific lengths charged at the nearest 25cm increment above.		A
cm	MW/AB/AG/CC £	
125*	26.60	
150*	31.88	
175*	37.18	
200*	42.48	
225*	47.80	
250*	53.08	
275*	58.43	
300	63.77	
325	69.03	
350	74.41	
375	79.66	
400	84.94	
425	90.28	
450	95.61	
475	100.88	
500	106.22	
525	111.49	
550	116.82	
575	122.13	
600	127.41	

Above prices are for systems ready-assembled. Substantial savings can be made for self-assembly. Rail can be supplied in full lengths or cut-to-size with accessories separately.

\*1080W Packed in Acetate: For sizes marked with an asterisk above we offer our 1080 in white only in clear acetate self-service display packaging. Prices are the same as indicated above. Min. order 12 lengths.

Optional Accessories		Price Ctg.
(additional charges may apply)		A
3016 Endstop, each, 100.		
3511 Glider, at 16 per metre, 100. Outer, 25,000 gliders.		
3570 Rotating glider, 100.		
3020 Hook. Metal, 100.		
3638 Reinforced corner piece for pelmets, each, 10.		
3603 Top fix brackets, white, black each, 10, 100.		
3548 Retrofit glider, 25, 100, 1000.		
3630 Universal bracket, brown gold, each, 10.		
3571/3582/3599 Hooks - see under 1021/5.		
3070 Twist eye endstop, white, black each, 10.		
1128R Screw 37mm/1½", No. 8 round head, 100.		
3089 Glider hook, 20.		

Rail and Standard Accessories		Price Ctg.
1080p Rail, silver, white, in 5m & 6m, matt white, antique bronze, anodic grey, black and charcoal in 6m.		A
3533 Glider Box, white, black 100. Self-service sachets, 25 x 25. Outer, 25,000. Euroslot sachet 25.		
3534 Glider, white, black in strip form, at 14/m.		
18R Screw 25mm/1". No. 8 round head, 100.		
3667 Endcover/stop, grey, white, black, matt white, anodic grey, antique bronze, charcoal. each 10, 100. Euroslot sachet 2 (white and grey only).		
3630 Universal nylon bracket, white, black at 600mm centres, each 10, 100. Euroslot sachet 2.		

System Prices		Price Ctg.
Specific lengths charged at the nearest 25cm increment above.		A
cm	W/S/BL £	
125*	26.60	
150*	31.88	
175*	37.18	
200*	42.48	
225*	47.80	
250*	53.08	
275*	58.43	
300	63.77	
325	69.03	
350	74.41	
375	79.66	
400	84.94	
425	90.28	
450	95.61	
475	100.88	
500	106.22	
525	111.49	
550	116.82	
575	122.13	
600	127.41	

6146 Nylon hook, 12.

3660 Extra long universal bracket.

3655 Long universal bracket.

3562 Standard tape, 100 metres.

3582 Curtain hooks, white, black.

3620 Connecting bridge, each, 10.

3602 Nylon wall support, white, each, 10.

3606 Snap fastener each, 10.

3618 Metal wall support, each, 10.

3626 Return fixing bracket, each.

3639 Hanger rod assembly, 2' system complete.

Smart Fix Brackets in W/S (BL, MW, AG, AB, CC available 1st April 2023)

11118 Smart Fix 60mm Bracket (11200 Set).

11119 Smart Fix 80mm Bracket (11201 Set).

11120 Smart Fix 100mm Bracket (11202 Set).

11121 Smart Fix 120mm Bracket (11203 Set).

11122 Smart Fix 150mm Bracket (11204 Set).

11123 Smart Fix 200mm Bracket (11205 Set).

Square Smart Fix Brackets in W/S (BL, MW, AG, AB, CC available 1st April 2023)

11139 Smart Fix 60mm Bracket (11210 Set).

11140 Smart Fix 80mm Bracket (11211 Set).

11141 Smart Fix 100mm Bracket (11212 Set).

11142 Smart Fix 120mm Bracket (11213 Set).

11143 Smart Fix 150mm Bracket (11214 Set).

11144 Smart Fix 200mm Bracket (11215 Set).

Smart Fix Bracket Covers

11116 Smart Fix Bracket Cover.

11137 Square Smart Fix Bracket Cover.

Universal Smart Fix Extension Bracket in white, black or silver

11154 Universal Smart Fix 120mm.

11155 Universal Smart Fix 150mm.

11156 Universal Smart Fix 200mm.

System Prices		Price Ctg.
Specific lengths charged at the nearest 25cm increment above.		A
cm	W/S/BL £	
125*	26.60	
150*	31.88	
175*	37.18	
200*	42.48	
225*	47.80	
250*	53.08	
275*	58.43	
300	63.77	
325	69.03	
350	74.41	
375	79.66	
400	84.94	
425	90.28	
450	95.61	
475	100.88	
500	106.22	
525	111.49	
550	116.82	
575	122.13	
600	127.41	

3151 Clearance spacer (for top boards).

Colours  
Other colours special order - see page 74.

Tools, etc

80018 Slotting tool.

7103 Portable hand operated bending tool.

7109 Portable electrically operated bending tool.

7806 Filler set for 1080 at 200cm for 7103/9.

0540 Bending tool for gradual curves.

Bending		Max. trade discount	33⅓%
Angle bend £35.50 each. Standard radius 10cm.			
Semi-circle or gradual curve £45.50 each. Arch £85.00 each. Standard radius 30cm.			

System Prices		Price Ctg.
Specific lengths charged at the nearest 25cm increment above.		A
cm	W/S/BL £	
125*	26.60	
150*	31.88	
175*	37.18	
200*	42.48	
225*	47.80	
250*	53.08	
275*	58.43	
300	63.77	
325	69.03	
350	74.41	
375	79.66	
400	84.94	
425	90.28	
450	95.61	
475	100.88	
500	106.22	
525	111.49	
550	116.82	
575	122.13	
600	127.41	

3600 Picture Hanging System

Use prices for 1080 rail only and 3606 supports, covers 3667 where necessary plus special components below.

3637A Cord ø 1.5mm nom.

3600 Picture hanging system complete (including 4x3663, cord 3637A & 3634 delrin height adjuster)

3657 Connecting bridge for picture hanging system.

3605 Endcover.

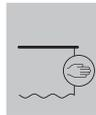

# Hand Operated Curtain Tracks

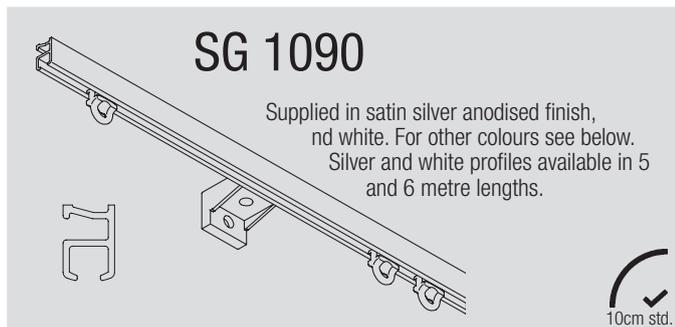

## SG 1090

Supplied in satin silver anodised finish, and white. For other colours see below. Silver and white profiles available in 5 and 6 metre lengths.

10cm std.

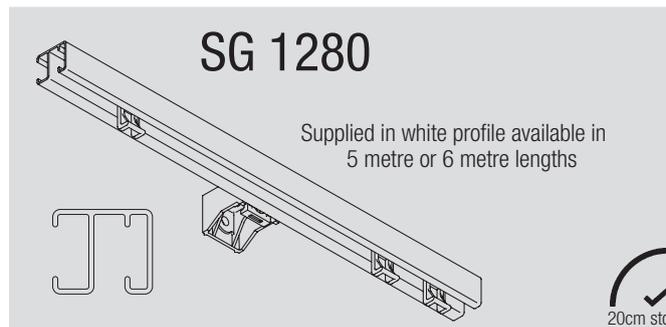

## SG 1280

Supplied in white profile available in 5 metre or 6 metre lengths

20cm std.

System Prices		Price Ctg.
Specific lengths charged at the nearest 25cm increment above.		A
cm	W/S £	
125	24.57	
150	29.51	
175	34.40	
200	39.35	
225	44.24	
250	49.11	
275	54.02	
300	58.95	
325	63.93	
350	68.87	
375	73.70	
400	78.63	
425	83.50	
450	88.46	
475	93.32	
500	98.30	
525	103.20	
550	108.08	
575	113.04	
600	117.89	
Above prices are for systems ready-assembled. Substantial savings can be made for self-assembly. Rail can be supplied in full lengths or cut-to-size with accessories separately.		

Rail and Standard Accessories		Price Ctg.
1090p Rail, silver and white in 5m, 6m or cut-to-size.		A
3533 Glider. Box, 100. Self-service sachets, 25 x 25. Outer, 25,000. Euroslot sachet 25.		
3534 Glider, in strip form, at 14 per metre. Outer, 1,000 gliders.		
3016 Endstop, each, 100.		
3175 Universal Nylon Bracket, white, 10, 100.		
Smart Fix Brackets in white, black or silver		
11118 Smart Fix 60mm Bracket (11200 Set).		
11119 Smart Fix 80mm Bracket (11201 Set).		
11120 Smart Fix 100mm Bracket (11202 Set).		
11121 Smart Fix 120mm Bracket (11203 Set).		
11122 Smart Fix 150mm Bracket (11204 Set).		
11123 Smart Fix 200mm Bracket (11205 Set).		
Square Smart Fix Brackets in white, black or silver		
11139 Smart Fix 60mm Bracket (11210 Set).		
11140 Smart Fix 80mm Bracket (11211 Set).		
11141 Smart Fix 100mm Bracket (11212 Set).		
11142 Smart Fix 120mm Bracket (11213 Set).		
11143 Smart Fix 150mm Bracket (11214 Set).		
11144 Smart Fix 200mm Bracket (11215 Set).		
Smart Fix Bracket Covers		
11116 Smart Fix Bracket Cover.		
11137 Square Smart Fix Bracket Cover.		
Colours		E
Other colours special order – see page 74.		
Tools		E
Sleeving SL1090, SL1090W per reel.		
80018 Slotting tool.		
7809 Filler set at 200cm, 2 required		
Bending		33 1/3%
Max. trade discount		
Angle bend £35.50 each. Standard radius 10cm.		
Semi-circle or gradual curve £45.50 each.		

All prices shown exclude VAT

System Prices		Price Ctg.
Specific lengths charged at the nearest 25cm increment above.		A
cm	White £	
125	40.43	
150	48.59	
175	56.58	
200	64.68	
225	72.75	
250	80.83	
275	88.94	
300	96.99	
325	105.11	
350	113.17	
375	121.26	
400	129.36	
425	137.37	
450	145.52	
475	153.63	
500	161.65	
525	169.74	
550	177.86	
575	185.95	
600	194.01	
Above prices are for systems ready-assembled. Substantial savings can be made for self-assembly. Rail can be supplied in full lengths or cut-to-size with accessories separately.		

Rail and Standard Accessories		Price Ctg.
1280p White rail, available in 5m or 6m lengths, in outsiders of 10 lengths only.		A
3630 Universal nylon bracket, white, at 600mm centres, 100.		
3922 Roller glider in strip form at 10 per metre, outer of 1,000 gliders, outer of 6,000 gliders.		
3985 Eyelet endcover/endstop in white, 100.		
18R Screw 25mm/1", No. 8 round head, 100.		
Smart Fix Brackets in white, black or silver		
11118 Smart Fix 60mm Bracket (11200 Set).		
11119 Smart Fix 80mm Bracket (11201 Set).		
11120 Smart Fix 100mm Bracket (11202 Set).		
11121 Smart Fix 120mm Bracket (11203 Set).		
11122 Smart Fix 150mm Bracket (11204 Set).		
11123 Smart Fix 200mm Bracket (11205 Set).		
Square Smart Fix Brackets in white, black or silver		
11139 Smart Fix 60mm Bracket (11210 Set).		
11140 Smart Fix 80mm Bracket (11211 Set).		
11141 Smart Fix 100mm Bracket (11212 Set).		
11142 Smart Fix 120mm Bracket (11213 Set).		
11143 Smart Fix 150mm Bracket (11214 Set).		
11144 Smart Fix 200mm Bracket (11215 Set).		
Smart Fix Bracket Covers		
11116 Smart Fix Bracket Cover.		
11137 Square Smart Fix Bracket Cover.		
Universal Smart Fix Extension Bracket in white, black or silver		
11154 Universal Smart Fix 120mm.		
11155 Universal Smart Fix 150mm.		
11156 Universal Smart Fix 200mm.		
3151 Clearance spacer (for top boards).		E
Colours		E
Other Colours Special Order – Consult Silent Gliss for pricing.		
Tools		E
7103 Portable hand operated bending tool.		
7109 Portable electrically operated bending tool.		
80018 Slotting tool.		
7844 Filler set for 7103/7109, 70cm.		
7844A Filler set for 0540, 200cm.		
0540 Bending tool for gradual curves		
Bending		33 1/3%
Max. trade discount		
Angle bend £35.50 each. Standard radius 20cm.		
Semi-circle or gradual curve £45.50 each.		

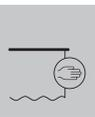

# Hand Operated Curtain Tracks

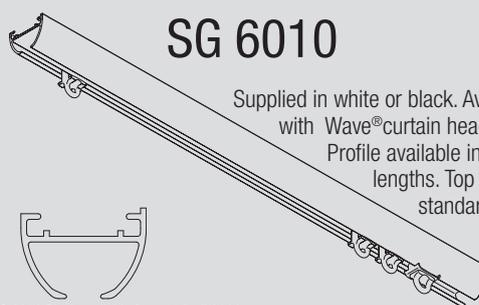

## SG 6010

Supplied in white or black. Available with Wave® curtain heading system. Profile available in 6 metre lengths. Top fix as standard.

SG 6010 Black available from 1<sup>st</sup> April 2023 15cm std.



## SG 6290

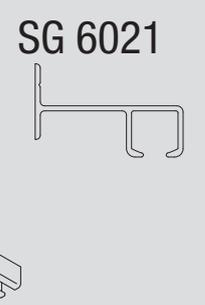

## SG 6021

Both profiles supplied in white. Available in 6m lengths.

System Prices				Price Ctg.
Specific lengths charged at the nearest 25cm increment above.				<b>A</b>
cm	W/BL Standard Glider £	W/BL 60mm Wave £	W/BL 80mm Wave £	
125	51.99	75.42	68.31	
150	59.08	87.41	78.87	
175	69.30	102.18	92.22	
200	76.39	114.17	102.79	
225	86.62	128.94	116.14	
250	93.71	140.93	126.70	
275	103.94	155.70	140.05	
300	111.03	167.69	150.62	
325	121.25	182.46	163.97	
350	128.34	194.45	174.53	
375	138.57	209.22	187.88	
400	145.66	221.21	198.45	
425	155.89	235.98	211.80	
450	162.98	247.97	222.36	
475	173.20	262.74	235.71	
500	180.29	274.73	246.28	
525	190.52	289.50	259.63	
550	197.61	301.49	270.19	
575	207.84	316.26	283.54	
600	214.93	328.25	294.11	
Above prices are for systems ready-assembled. Substantial savings can be made for self-assembly. Rail can be supplied in full lengths or cut-to-size with accessories separately.				

Enhanced Wave Options		Price Ctg.
Add the following to the systems prices above:		<b>A</b>
<b>Option 1</b> 2256 Adjustable Brake Single-stack £8.85; Pair-stack £17.69		
<b>Option 2</b> 2255 Adjustable Brake & 6366 Carrier Single-stack £17.97; Pair-stack £35.92		
<b>Option 3</b> Enhanced Wave (80mm only) Single-stack £33.34; Pair-stack £66.71		

Rail and Standard Accessories	
6010p Rail, white, black available in 6 metre lengths.	
3825 Clamp.	
6018 Endcover, white, black.	
6065 Twist eye end stop, white, black 10, 100.	
<b>Standard Gliders</b> 11301 2C Gliders in strip form, white, black at 14 per m, outer 1000.	
<b>Wave Gliders</b> 11302 Wave 2C Glider-cord 80mm, white, black. 11303 Wave 2C Glider-cord 60mm white, black.	

All prices shown exclude VAT

Optional Accessories		Price Ctg.
(additional charges may apply)		<b>A</b>
2255 Adjustable brake, white, black.		
2256 Adjustable brake, white, black.		
3020 Hook, Metal, 100.		
3571 Hook, Box, 100. Self-service sachets, 25 x 25. Outer, 35,000.		
3582 Curtain hooks, white, black.		
3599 Hook, box, white, black 100. Self-service sachets, 25 x 25. Outer, 25,000.		
3802 Connecting bridge.		
3826 Nylon bracket, white, black (top fix).		
3832 Clamp for top fixing.		
6053 Spring Stop, 10.		
6064 Endstop.		
6283 Roller-glider.		
6349 Wave®curtain tape, white, black.		
6364 Extension, white, black.		
6365 Hanger, white, black.		
6363 Iron-on hemming tape.		
6366 Draw rod carrier, white, black.		
10075 Lead curtain weight.		
10076 Fabric side weight.		
10430-10434 Draw rods, white, black or aluminium.		
11295 Endstop, Silver, White, Black each 10.		
1148C Screw.		

Colours		Price Ctg.
Other colours special order – consult Silent Gliss for pricing.		<b>E</b>

Tools		Price Ctg.
7103 Portable hand operated bending tool.		<b>E</b>
7109 Portable electrically operated bending tool.		
7885 Filler set 6010 at 200cm for 7103/7109.		
7439 Blocks for 7103/7109, 2 required.		
7404 Former for 7103/7109, radius 15cm.		

Bending		Price Ctg.
Max. trade discount	33 1/3%	
Angle bend £55.00 each. Standard radius 15 cm.		
Semi-circle or gradual curve £74.50 each.		

System Prices		Price Ctg.
Specific lengths charged at the nearest 25cm increment above.		<b>A</b>
6290 White		
cm	£	
125	24.14	
150	28.99	
175	33.75	
200	38.58	
225	43.44	
250	48.19	
275	53.07	
300	57.87	
325	62.74	
350	67.52	
375	72.39	
400	77.18	
425	82.02	
450	86.84	
475	91.67	
500	96.48	
525	101.30	
550	106.14	
575	110.97	
600	115.78	

System Prices		Price Ctg.
Specific lengths charged at the nearest 25cm increment above.		<b>A</b>
6021 White		
cm	£	
125	30.97	
150	37.17	
175	43.34	
200	49.51	
225	55.73	
250	61.90	
275	68.09	
300	74.25	
325	80.48	
350	86.71	
375	92.89	
400	99.06	
425	105.23	
450	111.43	
475	117.62	
500	123.82	
525	130.01	
550	136.17	
575	142.37	
600	148.60	

Above prices are for systems ready-assembled. Substantial savings can be made for self-assembly. Rail can be supplied in full lengths or cut-to-size with accessories separately.

Rail and Standard Accessories		Price Ctg.
6290p White rail, available in 6m lengths.		<b>A</b>
6021p White rail available in 6m lengths.		
6122 Endstop, 100.		
6148 Glider at 10 per m, 1,000.		
6149 Lead glider (blue) at 2 per length, 100.		
<b>Optional Accessories</b> (additional charges may apply)		<b>A</b>
0688 Self drilling wood screw, 100.		
3582 Hook, 100, 1,000, 20,000.		
3599 Hook, 100, 25,000.		
3562 Standard tape, 100m.		
10430 - 10434 Draw rods, white, black or aluminium		

Colours		Price Ctg.
To special order - see Page 74.		<b>E</b>

Bending	
Straight only.	

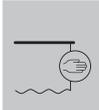

# Hand Operated Curtain Tracks

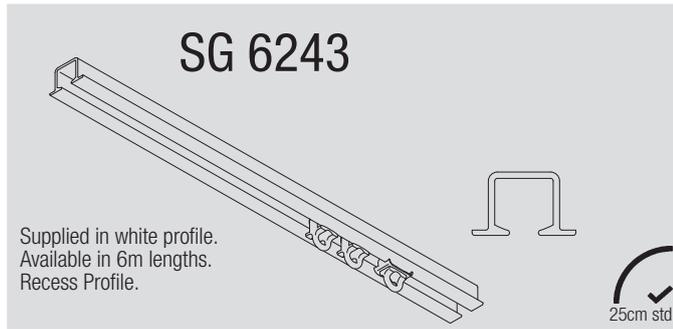

System Prices				Price Ctg.
Specific lengths charged at the nearest 25cm increment above.				A
cm	White Standard Glider	White Wave Glider		£
	£	60mm	80mm	
125	43.61	69.86	65.79	
150	49.11	80.62	75.73	
175	54.61	91.36	85.66	
200	60.11	102.12	95.59	
225	65.60	112.86	105.52	
250	71.10	123.61	115.46	
275	76.59	134.37	125.38	
300	82.09	145.10	135.31	
325	87.61	155.86	145.25	
350	93.10	166.61	155.18	
375	98.60	177.35	165.12	
400	104.07	188.10	175.05	
425	109.58	198.84	184.98	
450	115.06	209.59	194.91	
475	120.56	220.35	204.83	
500	126.08	231.08	214.78	
525	131.57	241.84	224.71	
550	137.05	252.58	234.64	
575	142.56	263.33	244.57	
600	148.05	274.08	254.51	

Prices above are for systems ready-assembled. Substantial savings can be made for self-assembly. Rail can be supplied in full lengths or cut-to-size with accessories separately.

Enhanced Wave Options		Price Ctg.
Add the following to the systems prices above:		A
<b>Option 1</b> 2255 Adjustable Brake Single-stack £8.85; Pair-stack £17.69		
<b>Option 2</b> 2255 Adjustable Brake & 6366 Carrier Single-stack £17.97; Pair-stack £35.92		
<b>Option 3</b> Enhanced Wave (80mm only) Single-stack £33.34; Pair-stack £66.71		

Rail and Standard Accessories		Price Ctg.
10711 Screw, 19mm, 100.		A
6053 Spring Stop, 10.		
6243p White rail available in 6m lengths only.		
6065 Twist eye end stop, 10, 100.		
7002 Rail protector.		
Plus one of the following options:		
<b>Standard Gliders</b> 11301 2C Gliders in strip form, at 14 per m, outer 1000.		
<b>Wave Gliders</b> 11302 Wave 2C Glider-cord 80mm. 11303 Wave 2C Glider-cord 60mm.		

All prices shown exclude VAT

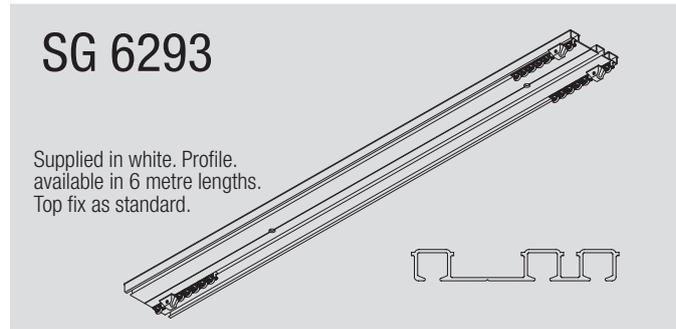

System Prices			Price Ctg.
Specific lengths charged at the nearest 25cm increment above.			A
cm	White Standard Glider	White *Std/Roller	£
	£	£	
125	70.32	93.08	
150	83.29	109.07	
175	96.27	127.62	
200	109.24	143.60	
225	122.21	162.15	
250	135.18	178.14	
275	148.15	196.69	
300	161.12	212.67	
325	174.10	231.22	
350	187.07	247.21	
375	200.04	265.76	
400	213.01	281.74	
425	225.98	300.29	
450	238.95	316.28	
475	251.92	334.82	
500	264.90	350.81	
525	277.87	369.36	
550	290.84	385.34	
575	303.81	403.89	
600	316.78	419.88	

Prices above are for systems ready-assembled. Substantial savings can be made for self-assembly. Rail can be supplied in full lengths or cut-to-size with accessories separately.

Rail and Standard Accessories		Price Ctg.
6065 Twist eye endstop, each, 10, 100.		A
6283 Roller glider at 10 per metre. Outer 10, 100.		
6293p Rail, white in 6m lengths.		
11301 2C Glider in strip form, at 14 per m, outer 1000.		

\*Standard 11301 gliders for voile and 6283 gliders for main curtains.

Optional Accessories		Price Ctg.
(additional charges may apply)		A
2255 Adjustable brake.		
2256 Adjustable brake.		
3020 Hook, Metal, 100.		
3067 Connecting bridge.		
3571 Hook. Box, 100. Self-service sachets, 25 x 25. Outer, 35,000.		
3582 Curtain hooks (each).		
3599 Hook. box, 100. Self-service sachets, 25 x 25. Outer, 25,000.		
6094 Roller glider with hook, 10, 100.		
6099 Roller glider-cord 80mm pitch. Outer of 50mm.		
6283 Roller glider at 10 per metre. Outer 10, 100.		
6349 Wave®curtain tape.		
6364 Extension.		
6365 Hanger.		
6366 Iron-on hemming tape.		
6366 Draw rod carrier.		
10075 Lead curtain weight.		
10076 Fabric side weight.		
10430-10434 Draw rods, white, black or aluminium.		
11295 Endstop, White, Silver or Black each 10.		

Colours	Price Ctg.
To special order – see page 74.	E

Tools	Price Ctg.
7230 Slotting tool.	E

Bending	Max. trade discount	Price Ctg.
Angle bend £35.50 each. Standard radius 25cm.	33½%	E
Gradual curve £45.50 each.		

Optional Accessories		Price Ctg.
(additional charges may apply)		A
3599 Hook. Box, 100. Self-service.		
6053 Spring stop, 10.		
6094 Roller glider with hook, 10, 100.		
6098 Roller glider with eye.		
6269 Connecting bridge.		
10430-10434 Draw Rods, white, black or aluminium.		

Colours	Price Ctg.
Other colours special order - see Page 74.	E

Bending	Price Ctg.
Straight only.	



# Hand Operated Curtain Tracks

## SG 6380

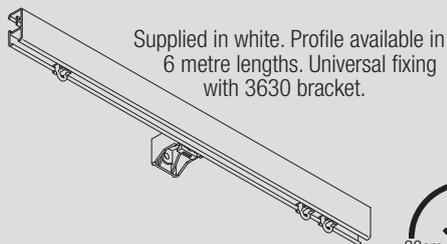

28cm std.

	Price Ctg.		Price Ctg.																																																																		
<b>System Prices</b>	<b>A</b>	<b>Optional Accessories</b>	<b>A</b>																																																																		
Specific lengths charged at the nearest 25cm increment above.		(additional charges may apply)																																																																			
<table border="1"> <thead> <tr> <th></th> <th>White Standard Glider</th> <th>White Roller Glider</th> </tr> <tr> <th></th> <th>£</th> <th>£</th> </tr> </thead> <tbody> <tr><td>125</td><td>55.58</td><td>77.98</td></tr> <tr><td>150</td><td>62.95</td><td>88.72</td></tr> <tr><td>175</td><td>72.43</td><td>103.42</td></tr> <tr><td>200</td><td>79.80</td><td>114.17</td></tr> <tr><td>225</td><td>89.27</td><td>128.87</td></tr> <tr><td>250</td><td>96.65</td><td>139.61</td></tr> <tr><td>275</td><td>106.13</td><td>154.31</td></tr> <tr><td>300</td><td>113.50</td><td>165.05</td></tr> <tr><td>325</td><td>122.98</td><td>179.75</td></tr> <tr><td>350</td><td>130.36</td><td>190.50</td></tr> <tr><td>375</td><td>139.84</td><td>205.20</td></tr> <tr><td>400</td><td>147.21</td><td>215.94</td></tr> <tr><td>425</td><td>156.68</td><td>230.64</td></tr> <tr><td>450</td><td>164.06</td><td>241.38</td></tr> <tr><td>475</td><td>173.53</td><td>256.08</td></tr> <tr><td>500</td><td>180.91</td><td>266.83</td></tr> <tr><td>525</td><td>190.39</td><td>281.53</td></tr> <tr><td>550</td><td>197.76</td><td>292.27</td></tr> <tr><td>575</td><td>207.24</td><td>306.97</td></tr> <tr><td>600</td><td>214.62</td><td>317.71</td></tr> </tbody> </table>		White Standard Glider	White Roller Glider		£	£	125	55.58	77.98	150	62.95	88.72	175	72.43	103.42	200	79.80	114.17	225	89.27	128.87	250	96.65	139.61	275	106.13	154.31	300	113.50	165.05	325	122.98	179.75	350	130.36	190.50	375	139.84	205.20	400	147.21	215.94	425	156.68	230.64	450	164.06	241.38	475	173.53	256.08	500	180.91	266.83	525	190.39	281.53	550	197.76	292.27	575	207.24	306.97	600	214.62	317.71		2255 Adjustable Brake. 3571 Hook. 3582 Hook, Box, 100. Self service sachets, 25x25. Outer, 1,000. Outer, 20,000. 3599 Hook, box 100, outer 25,000. 3603 Top fix bracket, white each, 10, 100. 3620 Connecting Bridge. 3655 Long universal bracket. 3660 Extra long universal bracket 6053 Spring stop, 10. 6064 Screw twist endstop each, 10. 6086 Spring stop each, 10, 100. 6146 Nylon hook, 100. 6094 Roller glider with hook, 10, 100. 6098 Roller glider with eye, 10, 100. 6349 Wave® curtain tape. 6363 Iron-on hemming tape. 6364 Extension. 6365 Hanger. 6366 Draw rod carrier. 10075 Lead curtain weight. 10076 Fabric side weight. 10430-10434 Draw Rods, white, black or aluminium 11295 Endstop white, black or silver. 11302 Wave 2C Glider-cord 80mm 11303 Wave 2C Glider-cord 60mm <b>Smart Fix Brackets in white, black or silver</b> 11118 Smart Fix 60mm Bracket (11200 Set). 11119 Smart Fix 80mm Bracket (11201 Set). 11120 Smart Fix 100mm Bracket (11202 Set). 11121 Smart Fix 120mm Bracket (11203 Set). 11122 Smart Fix 150mm Bracket (11204 Set). 11123 Smart Fix 200mm Bracket (11205 Set). <b>Square Smart Fix Brackets in white, black or silver</b> 11139 Smart Fix 60mm Bracket (11210 Set). 11140 Smart Fix 80mm Bracket (11211 Set). 11141 Smart Fix 100mm Bracket (11212 Set). 11142 Smart Fix 120mm Bracket (11213 Set). 11143 Smart Fix 150mm Bracket (11214 Set). 11144 Smart Fix 200mm Bracket (11215 Set). <b>Universal Smart Fix Extension Bracket in white, black or silver</b> 11154 Universal Smart Fix 120mm. 11155 Universal Smart Fix 150mm. 11156 Universal Smart Fix 200mm.	
	White Standard Glider	White Roller Glider																																																																			
	£	£																																																																			
125	55.58	77.98																																																																			
150	62.95	88.72																																																																			
175	72.43	103.42																																																																			
200	79.80	114.17																																																																			
225	89.27	128.87																																																																			
250	96.65	139.61																																																																			
275	106.13	154.31																																																																			
300	113.50	165.05																																																																			
325	122.98	179.75																																																																			
350	130.36	190.50																																																																			
375	139.84	205.20																																																																			
400	147.21	215.94																																																																			
425	156.68	230.64																																																																			
450	164.06	241.38																																																																			
475	173.53	256.08																																																																			
500	180.91	266.83																																																																			
525	190.39	281.53																																																																			
550	197.76	292.27																																																																			
575	207.24	306.97																																																																			
600	214.62	317.71																																																																			
<b>Rail and Standard Accessories</b>	<b>A</b>	<b>Colours</b>	<b>E</b>																																																																		
3630 Universal nylon bracket, white, 100. 6065 Twist eye end stop. 6283 Roller glider, 10, 100. 6380p Profile, white in 6m. 6381 Endcover, white. 11301 2C Glider in strip form at 14 per m, outer 1000.		Other colours special order - see Page 74.																																																																			
		<b>Bending</b>	33 1/3%																																																																		
		Max. trade discount Angle bend £35.50 each. Standard radius 28cm. Semi-circle or gradual curve £45.50 each.																																																																			

All prices shown exclude VAT

## SG 6465

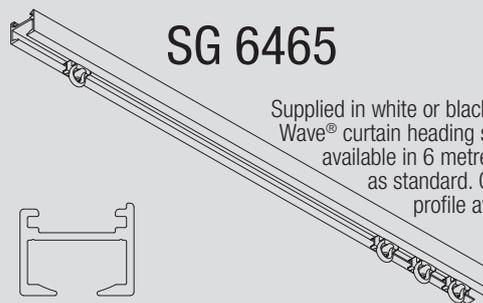

12cm std.

SG 6465 Black available from 1<sup>st</sup> April 2023

	Price Ctg.		Price Ctg.																																																																																								
<b>System Prices</b>	<b>A</b>	<b>Optional Accessories</b>	<b>A</b>																																																																																								
Specific lengths charged at the nearest 25cm increment above.		(additional charges may apply)																																																																																									
<table border="1"> <thead> <tr> <th></th> <th>W/BL Standard Glider</th> <th>W/BL Wave 60mm</th> <th>W/BL Wave 80mm</th> </tr> <tr> <th>cm</th> <th>£</th> <th>£</th> <th>£</th> </tr> </thead> <tbody> <tr><td>125</td><td>49.15</td><td>73.30</td><td>65.96</td></tr> <tr><td>150</td><td>56.86</td><td>86.05</td><td>77.25</td></tr> <tr><td>175</td><td>65.82</td><td>99.69</td><td>89.43</td></tr> <tr><td>200</td><td>73.53</td><td>112.45</td><td>100.72</td></tr> <tr><td>225</td><td>82.48</td><td>126.09</td><td>112.90</td></tr> <tr><td>250</td><td>90.19</td><td>138.84</td><td>124.19</td></tr> <tr><td>275</td><td>99.15</td><td>152.48</td><td>136.36</td></tr> <tr><td>300</td><td>106.86</td><td>165.24</td><td>147.65</td></tr> <tr><td>325</td><td>115.82</td><td>178.88</td><td>159.83</td></tr> <tr><td>350</td><td>123.53</td><td>191.63</td><td>171.12</td></tr> <tr><td>375</td><td>132.48</td><td>205.27</td><td>183.28</td></tr> <tr><td>400</td><td>140.19</td><td>218.03</td><td>194.57</td></tr> <tr><td>425</td><td>149.15</td><td>231.67</td><td>206.75</td></tr> <tr><td>450</td><td>156.86</td><td>244.42</td><td>218.04</td></tr> <tr><td>475</td><td>165.81</td><td>258.06</td><td>230.22</td></tr> <tr><td>500</td><td>173.52</td><td>270.82</td><td>241.51</td></tr> <tr><td>525</td><td>182.48</td><td>284.46</td><td>253.68</td></tr> <tr><td>550</td><td>190.19</td><td>297.21</td><td>264.97</td></tr> <tr><td>575</td><td>199.15</td><td>310.85</td><td>277.15</td></tr> <tr><td>600</td><td>206.86</td><td>323.61</td><td>288.44</td></tr> </tbody> </table>		W/BL Standard Glider	W/BL Wave 60mm	W/BL Wave 80mm	cm	£	£	£	125	49.15	73.30	65.96	150	56.86	86.05	77.25	175	65.82	99.69	89.43	200	73.53	112.45	100.72	225	82.48	126.09	112.90	250	90.19	138.84	124.19	275	99.15	152.48	136.36	300	106.86	165.24	147.65	325	115.82	178.88	159.83	350	123.53	191.63	171.12	375	132.48	205.27	183.28	400	140.19	218.03	194.57	425	149.15	231.67	206.75	450	156.86	244.42	218.04	475	165.81	258.06	230.22	500	173.52	270.82	241.51	525	182.48	284.46	253.68	550	190.19	297.21	264.97	575	199.15	310.85	277.15	600	206.86	323.61	288.44		2255 Adjustable brake, white, black. 3062 Connecting bridge. 3582 Curtain hooks white, black. 3599 Hook, white, black, box, 100. Self-service sachets, 25 x 25. Outer, 25,000. 6064 Endstop. 6349 Wave® curtain tape, white, black. 6364 Extension, white, black. 6365 Hanger, white, black. 6363 Iron-on hemming tape. 6366 Draw rod carrier, white, black. 10075 Lead curtain weight. 10076 Fabric side weight. 10430-10434 Draw rods, white, black or aluminium. 11231 Recess profile white and black. 11237 Wedge, white and black. 11239 Recess mask, white and black. 1148C Screw.	
	W/BL Standard Glider	W/BL Wave 60mm	W/BL Wave 80mm																																																																																								
cm	£	£	£																																																																																								
125	49.15	73.30	65.96																																																																																								
150	56.86	86.05	77.25																																																																																								
175	65.82	99.69	89.43																																																																																								
200	73.53	112.45	100.72																																																																																								
225	82.48	126.09	112.90																																																																																								
250	90.19	138.84	124.19																																																																																								
275	99.15	152.48	136.36																																																																																								
300	106.86	165.24	147.65																																																																																								
325	115.82	178.88	159.83																																																																																								
350	123.53	191.63	171.12																																																																																								
375	132.48	205.27	183.28																																																																																								
400	140.19	218.03	194.57																																																																																								
425	149.15	231.67	206.75																																																																																								
450	156.86	244.42	218.04																																																																																								
475	165.81	258.06	230.22																																																																																								
500	173.52	270.82	241.51																																																																																								
525	182.48	284.46	253.68																																																																																								
550	190.19	297.21	264.97																																																																																								
575	199.15	310.85	277.15																																																																																								
600	206.86	323.61	288.44																																																																																								
<b>Enhanced Wave Options</b>		<b>Recess Profile and Accessories White and Black</b>	<b>A</b>																																																																																								
Add the following to the systems prices above:		Charged at the nearest 25cm increment above.																																																																																									
<b>Option 1</b> 2255 Adjustable Brake Single-stack £8.85; Pair-stack £17.69 <b>Option 2</b> 2255 Adjustable Brake & 6366 Carrier Single-stack £17.97; Pair-stack £35.92 <b>Option 3</b> Enhanced Wave (80mm only) Single-stack £33.34; Pair-stack £66.71		Add to price Per Metre Per Length White £18.24 £4.41																																																																																									
<b>Rail and Standard Accessories</b>	<b>A</b>	<b>Colours</b>	<b>E</b>																																																																																								
6466 Rail, white, black available in 6 metre lengths. 3060 Clamp. 6065 Twist eye end stop, white, black 10, 100. 6471 Endcover, white, black. <b>Standard Gliders</b> 11301 2C Gliders in strip form, white, black, at 14 per m, outer 1000. <b>Wave Gliders</b> 11302 Wave 2C Glider-cord 80mm, white, black. 11303 Wave 2C Glider-cord 60mm, white, black.		Other colours special order – consult Silent Gliss for pricing.																																																																																									
		<b>Tools</b>	<b>E</b>																																																																																								
		7244 Notching tool for recess profile 11231																																																																																									
		<b>Bending</b>	33 1/3%																																																																																								
		Max. trade discount Angle bend £35.50 each. Standard radius 12cm. Semi-circle or gradual curve £45.50 each.																																																																																									
		Note: If using recess profile, add an additional 20% to the relevant bending charge above. Please note standard radius for 6465 with recess profile is 27cm.																																																																																									





# Hand Operated Curtain Tracks

## SG 6870

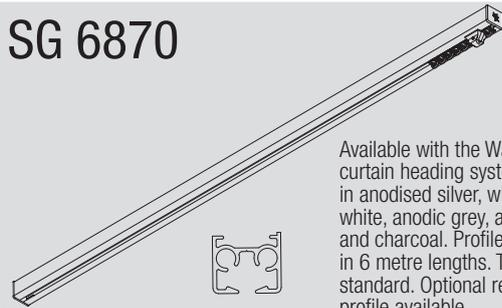

SG 6870 Black available from 1<sup>st</sup> April 2023

Available with the Wave® Standard curtain heading systems. Supplied in anodised silver, white, black, matt white, anodic grey, antique bronze and charcoal. Profile available in 6 metre lengths. Top fix standard. Optional recess profile available.

26cm std.

## SG 6970

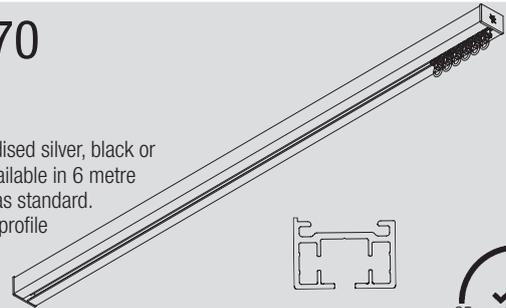

SG 6890 Black available from 1<sup>st</sup> April 2023

Supplied in anodised silver, black or white. Profile available in 6 metre lengths. Top fix as standard. Optional recess profile available.

25cm std.

	Price Qty.		Price Qty.
<b>System Prices</b> Specific lengths charged at the nearest 25cm increment above.	<b>A</b>	<b>Rail and Standard Accessories</b> 3825 Clamp, 10, 100. 6065 Endstop, white, black. 11190 Profile, silver, white, black, matt white, anodic grey, antique bronze, charcoal in 6m. 1148C Screw, 31mm/1¼", No. 8 countersunk, 100 11233 Endcover silver, white, matt white, black, anodic grey, antique bronze, charcoal. <b>Standard Gliders</b> 11301 2C Glider in strip form, white, black at 14 per m, outer 1000. <b>Wave Gliders</b> 11302 Wave 2C Glider-cord 80mm, white, black. 11303 Wave 2C Glider-cord 60mm, white, black.	<b>A</b>
<b>Using Standard Gliders</b> W/S/BL MW/AG/AB/CC cm £ £		<b>Optional Accessories</b> (additional charges may apply) 2255 Adjustable Brake, white, black. 2256 Adjustable brake, white, black. 3582 Hook, white, black, Box, 100. Self service sachets, 25x25.Outer, 1,000 Outer, 20,000. 3599 Hook, box 100, outer 25,000. 3802 Connecting Bridge. 3826 Nylon bracket, white, black (top fix). 3832 Clamp for top fixing. 3836 Nylon bracket, (face fix). 6053 Spring stop, 10. 6064 Endstop. 6086 Spring stop, white, black each 10, 100. 6094 Roller glider with hook, 10, 100. 6098 Roller glider with eye, white, black 10, 100. 6146 Nylon hook only, 12, 100. 6283 Roller glider, 10, 100. 6349 Wave®curtain tape, white, black. 6364 Extension, white, black. 6365 Hanger, white, black. 6363 Iron-on hemming tape. 6366 Draw rod carrier, white, black. 10075 Lead curtain weight. 10076 Fabric side weight. 10157 Wedge, white, black. 10430-10434 Draw Rods, white, black or aluminium 11230 Recess profile, white and black 6m 11238 Recess Mask, white and black 11295 Endstop white, black or silver. <b>Smart Fix Brackets in W/S (BL/MW/AG/AB/CC 01/04/23)</b> 11118 Smart Fix 60mm Bracket (11200 Set). 11119 Smart Fix 80mm Bracket (11201 Set). 11120 Smart Fix 100mm Bracket (11202 Set). 11121 Smart Fix 120mm Bracket (11203 Set). 11122 Smart Fix 150mm Bracket (11204 Set). 11123 Smart Fix 200mm Bracket (11205 Set). <b>Square Smart Fix Brackets in W/S (BL/MW/AG/AB/CC 01/04/23)</b> 11139 Smart Fix 60mm Bracket (11210 Set). 11140 Smart Fix 80mm Bracket (11211 Set). 11141 Smart Fix 100mm Bracket (11212 Set). 11142 Smart Fix 120mm Bracket (11213 Set). 11143 Smart Fix 150mm Bracket (11214 Set). 11144 Smart Fix 200mm Bracket (11215 Set). <b>Universal Smart Fix Extension Bracket in white, black or silver</b> 11154 Universal Smart Fix 120mm. 11155 Universal Smart Fix 150mm. 11156 Universal Smart Fix 200mm.	
<b>Using 60mm Standard Wave Gliders</b> W/S/BL MW/AG/AB/CC cm £ £		<b>Optional Accessories</b> (additional charges may apply) 2255 Adjustable Brake, white, black. 2256 Adjustable brake, white, black. 3582 Hook, white, black, Box, 100. Self service sachets, 25x25.Outer, 1,000 Outer, 20,000. 3599 Hook, box 100, outer 25,000. 3802 Connecting Bridge. 3826 Nylon bracket, white, black (top fix). 3832 Clamp for top fixing. 3836 Nylon bracket, (face fix). 6053 Spring stop, 10. 6064 Endstop. 6086 Spring stop, white, black each 10, 100. 6094 Roller glider with hook, 10, 100. 6098 Roller glider with eye, white, black 10, 100. 6146 Nylon hook only, 12, 100. 6283 Roller glider, 10, 100. 6349 Wave®curtain tape, white, black. 6364 Extension, white, black. 6365 Hanger, white, black. 6363 Iron-on hemming tape. 6366 Draw rod carrier, white, black. 10075 Lead curtain weight. 10076 Fabric side weight. 10157 Wedge, white, black. 10430-10434 Draw Rods, white, black or aluminium 11230 Recess profile, white and black 6m 11238 Recess Mask, white and black 11295 Endstop white, black or silver. <b>Smart Fix Brackets in W/S (BL/MW/AG/AB/CC 01/04/23)</b> 11118 Smart Fix 60mm Bracket (11200 Set). 11119 Smart Fix 80mm Bracket (11201 Set). 11120 Smart Fix 100mm Bracket (11202 Set). 11121 Smart Fix 120mm Bracket (11203 Set). 11122 Smart Fix 150mm Bracket (11204 Set). 11123 Smart Fix 200mm Bracket (11205 Set). <b>Square Smart Fix Brackets in W/S (BL/MW/AG/AB/CC 01/04/23)</b> 11139 Smart Fix 60mm Bracket (11210 Set). 11140 Smart Fix 80mm Bracket (11211 Set). 11141 Smart Fix 100mm Bracket (11212 Set). 11142 Smart Fix 120mm Bracket (11213 Set). 11143 Smart Fix 150mm Bracket (11214 Set). 11144 Smart Fix 200mm Bracket (11215 Set). <b>Universal Smart Fix Extension Bracket in white, black or silver</b> 11154 Universal Smart Fix 120mm. 11155 Universal Smart Fix 150mm. 11156 Universal Smart Fix 200mm.	
<b>Using 80mm Standard Wave Gliders</b> W/S/BL MW/AG/AB/CC cm £ £		<b>Optional Accessories</b> (additional charges may apply) 2255 Adjustable Brake, white, black. 2256 Adjustable brake, white, black. 3582 Hook, white, black, Box, 100. Self service sachets, 25x25.Outer, 1,000 Outer, 20,000. 3599 Hook, box 100, outer 25,000. 3802 Connecting Bridge. 3826 Nylon bracket, white, black (top fix). 3832 Clamp for top fixing. 3836 Nylon bracket, (face fix). 6053 Spring stop, 10. 6064 Endstop. 6086 Spring stop, white, black each 10, 100. 6094 Roller glider with hook, 10, 100. 6098 Roller glider with eye, white, black 10, 100. 6146 Nylon hook only, 12, 100. 6283 Roller glider, 10, 100. 6349 Wave®curtain tape, white, black. 6364 Extension, white, black. 6365 Hanger, white, black. 6363 Iron-on hemming tape. 6366 Draw rod carrier, white, black. 10075 Lead curtain weight. 10076 Fabric side weight. 10157 Wedge, white, black. 10430-10434 Draw Rods, white, black or aluminium 11230 Recess profile, white and black 6m 11238 Recess Mask, white and black 11295 Endstop white, black or silver. <b>Smart Fix Brackets in W/S (BL/MW/AG/AB/CC 01/04/23)</b> 11118 Smart Fix 60mm Bracket (11200 Set). 11119 Smart Fix 80mm Bracket (11201 Set). 11120 Smart Fix 100mm Bracket (11202 Set). 11121 Smart Fix 120mm Bracket (11203 Set). 11122 Smart Fix 150mm Bracket (11204 Set). 11123 Smart Fix 200mm Bracket (11205 Set). <b>Square Smart Fix Brackets in W/S (BL/MW/AG/AB/CC 01/04/23)</b> 11139 Smart Fix 60mm Bracket (11210 Set). 11140 Smart Fix 80mm Bracket (11211 Set). 11141 Smart Fix 100mm Bracket (11212 Set). 11142 Smart Fix 120mm Bracket (11213 Set). 11143 Smart Fix 150mm Bracket (11214 Set). 11144 Smart Fix 200mm Bracket (11215 Set). <b>Universal Smart Fix Extension Bracket in white, black or silver</b> 11154 Universal Smart Fix 120mm. 11155 Universal Smart Fix 150mm. 11156 Universal Smart Fix 200mm.	
Prices above are for systems ready-assembled. Substantial savings can be made for self-assembly. Rail can be supplied in full lengths or cut-to-size with accessories separately.		<b>Recess Profile and Accessories White or Black</b> Charged at the nearest 25cm increment above. Add to price Per Metre Per Length White £27.46 £9.79	<b>A</b>
<b>Enhanced Wave Options</b> Add the following to the systems prices above: <b>Option 1</b> 2256 Adjustable Brake Single-stack £8.85; Pair-stack £17.69 <b>Option 2</b> 2255 Adjustable Brake & 6366 Carrier Single-stack £17.97; Pair-stack £35.92 <b>Option 3</b> Enhanced Wave (80mm only) Single-stack £33.34; Pair-stack £66.71		<b>Colours</b> Other colours special order - see Page 74.	<b>E</b>
		<b>Tools</b> 7245 Notching tool for recess profile 11230	<b>E</b>
<b>All prices shown exclude VAT</b>		<b>Bending</b> Angle bend £55.00 each. Standard radius 26cm. Semi-circle or gradual curve £74.50 each. <b>Note:</b> If using recess profile, add an additional 20% to the relevant bending charge above. <b>Please Note:</b> Minimum radius for 6870 with recess profile is 50cm.	33 1/3%

	Price Qty.		Price Qty.
<b>System Prices</b> Specific lengths charged at the nearest 25cm increment above.	<b>A</b>	<b>Optional Accessories</b> (additional charges may apply) 3041 Bracket. 3582 Curtain hook, white, black box, 100 Self service sachets, 25 x 25. Outer, 20,000. 6349 Wave®curtain tape, white, black. 6363 Iron-on hemming tape. 7002 Profile protector. 10075 Lead weight 50/gr/m. 10076 Fabric weight. 10430 - 10434 Draw Rods, white, black or aluminium. <b>Smart Fix Brackets in white, black or silver.</b> 11118 Smart Fix 60mm Bracket (11200 Set). 11119 Smart Fix 80mm Bracket (11201 Set). 11120 Smart Fix 100mm Bracket (11202 Set). 11121 Smart Fix 120mm Bracket (11203 Set). 11122 Smart Fix 150mm Bracket (11204 Set). 11123 Smart Fix 200mm Bracket (11205 Set). <b>Square Smart Fix Brackets in white, black or silver.</b> 11139 Smart Fix 60mm Bracket (11210 Set). 11140 Smart Fix 80mm Bracket (11211 Set). 11141 Smart Fix 100mm Bracket (11212 Set). 11142 Smart Fix 120mm Bracket (11213 Set). 11143 Smart Fix 150mm Bracket (11214 Set). 11144 Smart Fix 200mm Bracket (11215 Set). <b>Universal Smart Fix Extension Brackets in white black or silver</b> 11154 Universal Smart Fix 120mm. 11155 Universal Smart Fix 150mm. 11156 Universal Smart Fix 200mm.	<b>A</b>
<b>Using Standard Gliders</b> W/S/BL MW/AG/AB/CC cm £ £		<b>Recess Profile and Accessories White or Black</b> Charged at the nearest 25cm increment above. Add to price Per Metre Per Length White £48.17 £9.10	
<b>Using 60mm Standard Wave Gliders</b> W/S/BL MW/AG/AB/CC cm £ £		<b>Colours</b> Other colours special order - see Page 74.	<b>E</b>
<b>Using 80mm Standard Wave Gliders</b> W/S/BL MW/AG/AB/CC cm £ £		<b>Tools</b> 7246 Notching tool for recess profile 10862	<b>E</b>
Prices above are for systems ready-assembled. Substantial savings can be made for self-assembly. Rail can be supplied in full lengths or cut-to-size with accessories separately.		<b>Bending</b> For each bend add the following to above system price: Radius/cm 25-99 £166.50 each. Over 99 £313.00 each. <b>Note:</b> If using recess profile, add an additional 20% to the relevant bending charge above. Please note: Standard radius for 6970 is 25cm. Minimum radius for 6970 with recess profile is 50cm.	25%

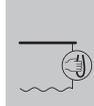

# Cord Operated Curtain Tracks

## SG 3000

Supplied in white. Profile available in 5 or 6 metre lengths.

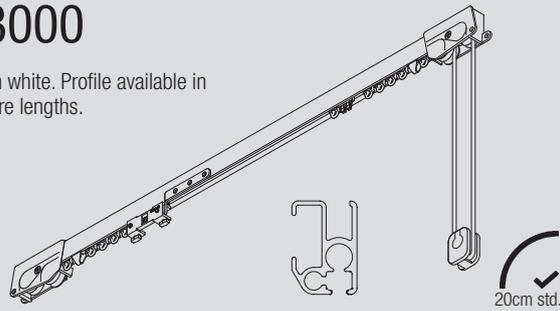

20cm std.

## SG 3840

Supplied in anodised silver, white, black, matt white, anodic grey, antique bronze and charcoal. Available in 6 metre lengths only. Available with the Wave® Standard curtain heading systems. Top fixed as standard.

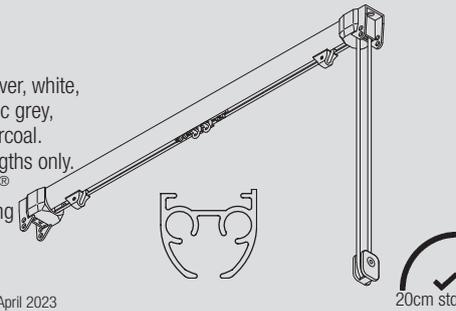

20cm std.

System Prices		Price Ctg.
Specific lengths charged at the nearest 25cm increment above.		A
cm	White £	
125	103.60	
150	110.79	
175	118.00	
200	125.25	
225	132.38	
250	139.59	
275	146.80	
300	154.00	
325	161.15	
350	168.34	
375	175.59	
400	182.79	
425	189.98	
450	197.12	
475	204.39	
500	211.55	
525	218.74	
550	225.96	
575	233.12	
600	240.33	

Above prices are for systems ready-assembled. Substantial savings can be made for self-assembly. Rail can be supplied in full lengths or cut-to-size with accessories separately.

Rail and Standard Accessories	Price Ctg.
18R Screw 25mm/1", No. 8 round head, 100.	A
1082 Rail, white in 5m, 6m.	
1105 Spacer for cord pull end.	
1348R Screw round head No. 8 44mm/1 3/4" for spacer 1105, 100.	
3070 Twist eye endstop, each 10.	
3090 Cord 100, metres, 500 metres.	
3242 Overlap, each, 10, 100. Euroslot sachet 1.	
3288 Pair of endpieces, including Pilot runners 3030/3213, white. Outer, 25 sets, per set.	
3533 Glider. Box, 100. Self-service sachets, 25 x 25. Outer, 25,000. Euroslot sachet 25.	
3534 Glider, in strip form, 14 per metre. Outer, 1,000 gliders.	
3630 Universal bracket, white, each, 10, 100, Euroslot sachet 2.	

10731 Cord retainer	E
---------------------	---

Optional Accessories	Price Ctg.
(Additional charges may apply)	A
1128R Screw 36mm/1 1/2", No. 8 round head, 100.	
3020 Hook. Metal, 100.	
3032 Springstop, 10, 100.	
3045 Metal overlap arm, each, 10.	
3151 Clearance spacer (for top boards).	
3208 Intermediate pulley, white, grey, antique bronze, black, gold, each, 10.	
3231 End fixing bracket, each, 10.	
3289/3289W Set end pieces with return, including pilot runners, set.	
3511 Glider, at 16 per metre, 100. Outer, 25,000 gliders.	
3562 Standard tape, 100 metres.	
3570 Rotating glider, 100.	
3571 Hook. Box 100. Self-service sachets, 25 x 25. Outer 35,000. Euroslot sachet 25.	
3582 Hook. Box, 100 Self-service sachets, 25 x 25. Euroslot sachets 25. Outer, 1000. Outer, 20,000.	
3599 Hook. Box, 100. Self-service sachets, 25 x 25. Euroslot sachet 25. Outer, 25,000.	
3603 Top fix brackets, white at 600mm centres each, 100. Euroslot sachet 2.	
3620 Connecting bridge, each.	
3655 Long universal bracket.	
3660 Extra long universal bracket.	
Smart Fix Brackets in white, black or silver	
11118 Smart Fix 60mm Bracket (11200 Set).	
11119 Smart Fix 80mm Bracket (11201 Set).	
11120 Smart Fix 100mm Bracket (11202 Set).	
11121 Smart Fix 120mm Bracket (11203 Set).	
11122 Smart Fix 150mm Bracket (11204 Set).	
11123 Smart Fix 200mm Bracket (11205 Set).	
Square Smart Fix Brackets in white, black or silver	
11139 Smart Fix 60mm Bracket (11210 Set).	
11140 Smart Fix 80mm Bracket (11211 Set).	
11141 Smart Fix 100mm Bracket (11212 Set).	
11142 Smart Fix 120mm Bracket (11213 Set).	
11143 Smart Fix 150mm Bracket (11214 Set).	
11144 Smart Fix 200mm Bracket (11215 Set).	
Smart Fix Bracket Covers	
11116 Smart Fix Bracket Cover.	
11137 Square Smart Fix Bracket Cover.	

Colours	Price Ctg.
Other colours special order – see page 74.	E

Tools	Price Ctg.
SL3000 Reel, sleeving.	E
SL3000W Reel, sleeving. 80018	
Slotting tool. 7103 Portable hand operated bending tool.	
7004 Cording needle.	
7109 Portable electrically operated bending tool.	
Instruction leaflet.	
7805 Filler set 3000 at 200cm for 7103/9.	
0540 Bending tool for gradual curves.	

Bending	Max. trade discount	Price Ctg.
Angle bend £40.50 each. Standard radius 20cm.		33 1/3%
Gradual curve £60.00 each.		

System Prices		Using Standard Gliders		Using Roller Gliders		Price Ctg.
cm	W/S/BL £	MW/AG/AB/CC £	W/S £	MW/AG/AB/CC £		A
125	100.06	129.19	113.76	142.90		
150	110.14	143.47	126.55	159.89		
175	120.11	157.71	139.38	177.02		
200	130.21	172.05	152.08	193.93		
225	140.27	186.32	164.94	210.99		
250	150.29	200.56	177.73	228.01		
275	160.35	214.87	190.42	244.97		
300	170.43	229.12	203.22	261.92		
325	180.37	243.41	215.94	281.47		
350	190.42	257.64	228.84	296.02		
375	200.47	271.96	241.60	313.10		
400	210.55	286.22	254.37	330.04		
425	220.56	300.47	267.14	347.05		
450	230.63	314.75	279.92	364.03		
475	240.63	328.99	292.75	381.10		
500	250.77	343.31	305.51	398.02		
525	260.77	357.56	318.27	415.02		
550	270.84	371.83	331.05	432.01		
575	280.86	386.15	343.87	449.18		
600	290.94	400.36	356.68	466.10		

Using Standard Wave Gliders		60mm glider-cord		80mm glider-cord	
cm	W/S/BL £	MW/AG/AB/CC £	W/S/BL £	MW/AG/AB/CC £	
125	122.24	151.38	118.04	147.18	
150	136.74	170.08	131.93	165.26	
175	151.15	188.76	145.16	182.76	
200	165.68	207.53	158.52	200.36	
225	180.17	226.23	172.38	218.35	
250	194.62	244.89	185.66	235.94	
275	209.12	263.65	199.54	254.08	
300	223.64	282.34	212.89	271.60	
325	238.02	301.06	226.09	289.13	
350	252.52	319.72	239.98	307.17	
375	267.00	338.48	253.27	324.76	
400	281.50	357.17	266.61	342.27	
425	295.93	375.86	280.42	360.35	
450	310.45	394.55	293.77	377.86	
475	324.90	413.27	307.59	395.96	
500	339.48	432.00	321.00	413.52	
525	353.92	450.69	334.27	431.04	
550	368.40	469.38	348.13	449.11	
575	382.85	488.15	361.41	466.71	
600	397.36	506.80	374.74	484.18	

Using Wave Roller Gliders		80mm glider cord	
cm	W/S £	MW/AG/AB/CC £	
125	176.23	205.36	
150	201.50	234.84	
175	226.83	264.44	
200	252.02	293.87	
225	277.35	323.42	
250	302.66	352.93	
275	327.85	382.38	
300	353.12	411.83	
325	378.36	441.40	
350	403.72	470.92	
375	428.98	500.46	
400	454.25	529.92	
425	479.50	559.43	
450	504.79	588.89	
475	530.09	618.46	
500	555.34	647.87	
525	580.59	677.35	
550	605.88	706.86	
575	631.18	736.49	
600	656.49	765.92	

Track lengths between those specified will be charged at the rate for the nearest standard length above. Above prices are for systems ready-assembled. Substantial savings can be made for self-assembly. Rail can be supplied in full lengths or cut-to-size with accessories separately.

All prices shown exclude VAT



## Cord Operated Curtain Tracks

### SG 3840

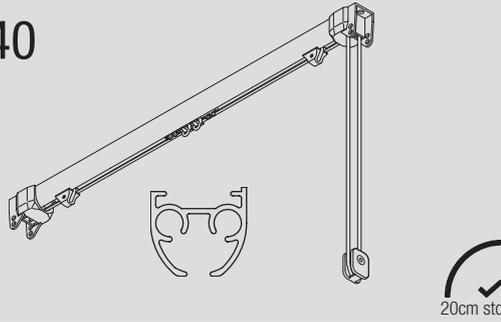

	Price Ctg.
<b>Rail and Standard Accessories</b>	<b>A</b>
1148C Screw, 31mm/1¼", No. 8 countersunk, 100.	
3090 Cord, 100 metres. 500 metres.	
3091 Cord, 100 metres, black.	
3825 Clamp, 10, 100.	
3841 Rail, silver, white, black, matt white, anodic grey, antique bronze, charcoal available in 6m.	
3845 Endpiece set, white, black, grey, matt white, anodic grey, antique bronze, charcoal.	
6086 Spring stop, white, black each 10, 100.	
6288 Plastic overlap arm white, black, each, 10.	
Plus one of the following glider options:	
<b>Standard Gliders</b>	
11301 2C Gliders in strip form white, black, at 14 per m, outer 1000.	
<b>Roller Gliders</b>	
6283 Roller glider, white at 10 per metre. Outer 10, 100.	
<b>Wave Gliders</b>	
6099 Roller glider-cord, white 80mm pitch. Outer of 50mm.	
11302 2C Wave glider-cord 80mm, white, black	
11303 2C Wave glider-cord 60mm, white, black	<b>E</b>
10731 Cord retainer	<b>A</b>

	Price Ctg.
<b>Optional Accessories</b> (additional charges may apply).	
3020 Hook, Metal, 100.	
3562 Standard tape, 100 metres.	
3571 Hook, Box, 100. Self-service sachets, 25 x 25. Outer, 35,000.	
3582 Curtain hooks, white, black.	
3582 Hook, Box, 100. Self-service sachets, 25 x 25. Outer, 20,000.	
3599 Hook, white, black Box 100. Self-service sachets, 25 x 25. Outer, 25,000.	
3802 Connecting bridge, each.	
3826 Nylon bracket, white, black (top fix).	
3832 Clamp for top fixing.	
3833A Intermediate pulley, white, black each.	
3836 Nylon bracket, (face fix).	
3846 Endpieces set with return including pair of pilot runners and 2 x 3816 endpieces, white.	
6063 Overlap arm, each, 10.	
6094 Roller glider with hook, 10, 100.	
6098 Roller glider with eye, white, black.	
6099 Roller glider, white cord 80mm.	
6349 Wave® curtain tape, white, black.	
6363 Iron-on hemming tape.	
6364 Extension, white, black.	
6365 Hanger, white, black.	

All prices shown exclude VAT

	Price Ctg.
<b>Smart Fix Brackets in W/S (BL, MW, AG, AB, CC available 1st April 2023)</b>	<b>A</b>
11118 Smart Fix 60mm Bracket (11200 Set).	
11119 Smart Fix 80mm Bracket (11201 Set).	
11120 Smart Fix 100mm Bracket (11202 Set).	
11121 Smart Fix 120mm Bracket (11203 Set).	
11122 Smart Fix 150mm Bracket (11204 Set).	
11123 Smart Fix 200mm Bracket (11205 Set).	
<b>Square Smart Fix Brackets in W/S (BL, MW, AG, AB, CC available 1st April 2023)</b>	
11139 Smart Fix 60mm Bracket (11210 Set).	
11140 Smart Fix 80mm Bracket (11211 Set).	
11141 Smart Fix 100mm Bracket (11212 Set).	
11142 Smart Fix 120mm Bracket (11213 Set).	
11143 Smart Fix 150mm Bracket (11214 Set).	
11144 Smart Fix 200mm Bracket (11215 Set).	
<b>Smart Fix Bracket Covers</b>	
11116 Smart Fix Bracket Cover.	
11137 Square Smart Fix Bracket Cover.	
<b>Universal Smart Fix Extension Bracket in white, black or silver</b>	
11154 Universal Smart Fix 120mm.	
11155 Universal Smart Fix 150mm.	
11156 Universal Smart Fix 200mm	
<b>Colours</b>	<b>E</b>
Other colours special order – see page 74.	

	Price Ctg.
<b>Tools</b>	<b>E</b>
7103 Portable hand operated bending tool.	
7109 Portable electrically operated bending tool.	
7802 Filler set 3840 at 200cm for 7103/9.	
<b>Enhanced Wave®System supplement per system £</b>	
80mm Single-stack	21.15
80mm Pair-stack	42.33

	Max. trade discount	33⅓%
<b>Bending</b>		
Angle bend £55.00 each. Standard radius 20cm.		
Semi-circle or gradual curve £74.50 each.		

### SG 3870

Supplied in anodised silver, white, black, matt white, anodic grey, antique bronze and charcoal. Available with the Wave® Standard curtain heading systems. Available in 6 metre lengths. Top fix as standard. Optional recess profile available.

SG 3870 Black available from 1st April 2023

	Price Ctg.
<b>System Prices</b> Specific lengths charged at the nearest 25cm increment above.	<b>A</b>
<b>Using Standard Gliders</b>	
W/S/BL	MW/AG/AB/CC
cm	£
125	106.81
150	115.19
175	126.80
200	135.18
225	146.80
250	155.18
275	166.80
300	175.18
325	186.79
350	195.17
375	206.79
400	215.17
425	226.79
450	235.17
475	246.78
500	255.16
525	266.78
550	275.16
575	286.77
600	295.16
<b>Using 60mm Standard Wave Gliders</b>	
W/S/BL	MW/AG/AB/CC
cm	£
125	130.95
150	144.38
175	160.68
200	174.10
225	190.40
250	203.83
275	220.13
300	233.55
325	249.85
350	263.28
375	279.58
400	293.01
425	309.31
450	322.73
475	339.03
500	352.46
525	368.76
550	382.18
575	398.48
600	411.91

	Price Ctg.
<b>Using 80mm Standard Wave Gliders</b>	
W/S/BL	MW/AG/AB/CC
cm	£
125	123.64
150	135.61
175	150.44
200	162.41
225	177.24
250	189.21
275	204.05
300	216.01
325	230.85
350	242.81
375	257.65
400	269.61
425	284.45
450	296.42
475	311.25
500	323.22
525	338.06
550	350.02
575	364.86
600	376.82
Prices above are for systems ready-assembled. Substantial savings can be made for self-assembly. Rail can be supplied in full lengths or cut-to-size with accessories separately.	
<b>Enhanced Wave®System supplement per system £</b>	
80mm Single-stack	21.15
80mm Pair-stack	42.33

	Max. trade discount	33⅓%
<b>Bending</b>		
Angle bend £55.00 each. Standard radius 26cm.		
Semi-circle or gradual curve £74.50 each.		

	Price Ctg.
<b>Rail &amp; Standard Accessories</b>	
3090 Cord 100, metres, 500 metres, white.	
3091 Cord, loom, black.	
3825 Clamp at 30cm intervals, 10, 100.	
6086 Spring stop, white, black each 10, 100.	
6288 Plastic overlap arm, white, black each, 10.	
11190 Rail, silver, white, black, matt white, anodic grey, antique bronze, charcoal in 6m.	
11285 Guide set, silver, white, black matt white, anodic grey, antique bronze, charcoal.	
1148C Screw, 31mm/1¼", No. 8 counter-sunk, 100.	

	Price Ctg.
<b>Standard Gliders</b>	
11301 2C Glider in strip form, white, black at 14 per m, outer 1000.	
<b>Wave Gliders</b>	
11302 Wave 2C Glider-cord 80mm, white, black.	
11303 Wave 2C Glider-cord 60mm, white, black.	
10731 Cord retainer, white, black.	<b>E</b>
<b>Optional Accessories</b> (Additional charges may apply)	<b>A</b>
3020 Hook, Metal, 100.	
3571 Hook, Box, 100. Self-service sachets, 25 x 25. Outer, 35,000.	
3582 Hook, white, black Box, 100. Self-service sachets, 25 x 25. Outer, 25,000.	
3599 Hook, white, black Box, 100. Self-service sachets, 25 x 25. Outer, 25,000.	
3802 Connecting bridge, each.	
3826 Nylon bracket, white, black (top fix).	
3832 Clamp for top fixing.	
3836 Nylon bracket, (face fix).	
6053 Spring Stop, 10.	
6063 Overlap arm, each, 10.	
6064 Endstop.	
6065 Twist eye endstop, white, black each, 10.	
6094 Roller glider with hook, 10, 100.	
6098 Roller glider with eye, white, black 10, 100.	
6283 Roller glider, white, 10, 100.	
6349 Wave® curtain tape, white, black.	
6363 Iron-on hemming tape.	
6364 Extension, white, black.	
6365 Hanger, white, black.	
10075 Lead weight 50 gr/m.	
10076 Fabric weight.	
10157 Wedge for recess profile, white, black.	
11230 Recess profile white or black in 6m.	
11238 Recess mask, white, black.	
11295 Endstop, white, silver or black each 10.	
<b>Smart Fix Brackets in W/S (BL, MW, AG, AB, CC available 1st April 2023)</b>	
11118 Smart Fix 60mm Bracket (11200 Set).	
11119 Smart Fix 80mm Bracket (11201 Set).	
11120 Smart Fix 100mm Bracket (11202 Set).	
11121 Smart Fix 120mm Bracket (11203 Set).	
11122 Smart Fix 150mm Bracket (11204 Set).	
11123 Smart Fix 200mm Bracket (11205 Set).	
<b>Square Smart Fix Brackets in W/S (BL, MW, AG, AB, CC available 1st April 2023)</b>	
11139 Smart Fix 60mm Bracket (11210 Set).	
11140 Smart Fix 80mm Bracket (11211 Set).	
11141 Smart Fix 100mm Bracket (11212 Set).	
11142 Smart Fix 120mm Bracket (11213 Set).	
11143 Smart Fix 150mm Bracket (11214 Set).	
11144 Smart Fix 200mm Bracket (11215 Set).	
<b>Smart Fix Bracket Covers</b>	
11116 Smart Fix Bracket Cover.	
11137 Square Smart Fix Bracket Cover.	
<b>Universal Smart Fix Extension Bracket in white, black or silver</b>	
11154 Universal Smart Fix 120mm.	
11155 Universal Smart Fix 150mm.	
11156 Universal Smart Fix 200mm.	

	Price Ctg.
<b>Recess Profile and Accessories White or Black</b> Charged at the nearest 25cm increment above.	<b>A</b>
Add to price	
White	Per Metre £27.46
	Per Length £9.79
<b>Tools</b>	<b>E</b>
7245 Notching tool for recess profile 11230	

	Price Ctg.
<b>Bending</b>	
Angle bend £55.00 each. Standard radius 26cm.	
Semi-circle or gradual curve £74.50 each.	
<b>Note:</b> If using recess profile, add an additional 20% to the relevant bending charge above. Please note: Standard angle radius with recess profile is 50cm	



# Cord Operated Curtain Tracks

## SG 3900

Supplied in White. Profile available in 5 metre or 6 metre lengths.

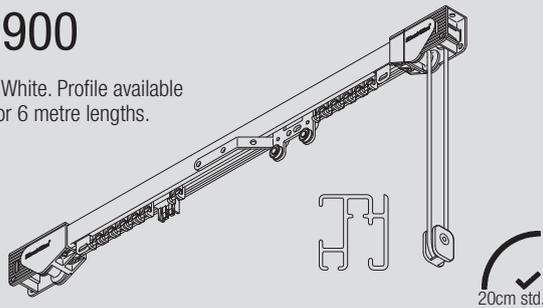

	Price Ctgy.		Price Ctgy.																																										
<p><b>System Prices</b> Specific lengths charged at the nearest 25cm increment above.</p> <table border="1"> <thead> <tr> <th>cm</th> <th>White £</th> </tr> </thead> <tbody> <tr><td>125</td><td>104.24</td></tr> <tr><td>150</td><td>114.46</td></tr> <tr><td>175</td><td>124.78</td></tr> <tr><td>200</td><td>134.95</td></tr> <tr><td>225</td><td>145.30</td></tr> <tr><td>250</td><td>155.54</td></tr> <tr><td>275</td><td>165.83</td></tr> <tr><td>300</td><td>176.10</td></tr> <tr><td>325</td><td>186.33</td></tr> <tr><td>350</td><td>196.61</td></tr> <tr><td>375</td><td>206.90</td></tr> <tr><td>400</td><td>217.15</td></tr> <tr><td>425</td><td>227.36</td></tr> <tr><td>450</td><td>237.67</td></tr> <tr><td>475</td><td>247.94</td></tr> <tr><td>500</td><td>258.22</td></tr> <tr><td>525</td><td>268.43</td></tr> <tr><td>550</td><td>278.74</td></tr> <tr><td>575</td><td>288.98</td></tr> <tr><td>600</td><td>299.19</td></tr> </tbody> </table> <p>Prices above are for systems ready-assembled. Substantial savings can be made for self-assembly. Rail can be supplied in full lengths or cut-to-size with accessories separately.</p>	cm	White £	125	104.24	150	114.46	175	124.78	200	134.95	225	145.30	250	155.54	275	165.83	300	176.10	325	186.33	350	196.61	375	206.90	400	217.15	425	227.36	450	237.67	475	247.94	500	258.22	525	268.43	550	278.74	575	288.98	600	299.19	A	<p><b>Optional Accessories</b> (additional charges may apply)</p> <p>3582 Hook, box 100, outer 1,000, outer 20,000. 3599 Hook, box 100, outer, 25,000. 3603 Top fix bracket, white, at 600mm centres, outer of 100. 3151 Clearance spacer (for top boards). 3620 Connecting bridge, each. 3655 Long universal bracket. 3660 Extra long universal bracket, each. 3914 Bracket for return profile, each. 3916 Pilot runner for multi stack system. 3929 Intermediate pulley, white, each 10. 3932 Spring stop, each 10. 3935 Straight overlap arm, each, 10. 3639 Hanger assembly complete, each.</p> <p>Smart Fix Brackets in white, black or silver</p> <p>11118 Smart Fix 60mm Bracket (11200 Set). 11119 Smart Fix 80mm Bracket (11201 Set). 11120 Smart Fix 100mm Bracket (11202 Set). 11121 Smart Fix 120mm Bracket (11203 Set). 11122 Smart Fix 150mm Bracket (11204 Set). 11123 Smart Fix 200mm Bracket (11205 Set).</p> <p>Square Smart Fix Brackets in white, black or silver</p> <p>11139 Smart Fix 60mm Bracket (11210 Set). 11140 Smart Fix 80mm Bracket (11211 Set). 11141 Smart Fix 100mm Bracket (11212 Set). 11142 Smart Fix 120mm Bracket (11213 Set). 11143 Smart Fix 150mm Bracket (11214 Set). 11144 Smart Fix 200mm Bracket (11215 Set).</p> <p>Smart Fix Bracket Covers</p> <p>11116 Smart Fix Bracket Cover. 11137 Square Smart Fix Bracket Cover.</p> <p>Universal Smart Fix Extension Bracket in white, black or silver</p> <p>11154 Universal Smart Fix 120mm. 11155 Universal Smart Fix 150mm. 11156 Universal Smart Fix 200mm.</p>	A
cm	White £																																												
125	104.24																																												
150	114.46																																												
175	124.78																																												
200	134.95																																												
225	145.30																																												
250	155.54																																												
275	165.83																																												
300	176.10																																												
325	186.33																																												
350	196.61																																												
375	206.90																																												
400	217.15																																												
425	227.36																																												
450	237.67																																												
475	247.94																																												
500	258.22																																												
525	268.43																																												
550	278.74																																												
575	288.98																																												
600	299.19																																												
<p><b>Rail &amp; Standard Accessories</b></p> <p>18R Screw 25mm/1" No. 8 round head, 100. 3982W White rail, available in 5m or 6m lengths, in outers of 10 lengths only. 3630 Universal nylon bracket, white, at 600mm centres, 100. 3090 Cord, 100 metres, 500 metres. 3915 Endpiece set, incl. pilot runners 3939/3917, white, outer of 20 or 50 only. 3922 Roller glider in strip form at 10 per metre, outer of 1,000 gliders, outer of 6,000 gliders. 3936 Overlap arm, outer of 20 only.</p>	A	<p><b>Tools</b></p> <p>7103 Portable hand operated bending tool. 7109 Portable electrically operated bending tool. 0545 Bending kit for 7103/7109 including filler set, blocks, arms and rings. 80018 Slotting tool. 7803 Filler set for 7103/7109, 200cm. 0540 Bending tool for gradual curves.</p>	E																																										
<p>10731 Cord retainer</p>	E	<p><b>Bending</b></p> <p>Max. trade discount 33 1/3%</p> <p>Angle bend £55.00 each. Standard radius 20cm. Gradual curve £74.50 each.</p>																																											

All prices shown exclude VAT



# Heavy Duty Curtain Tracks

## SG 3970

Supplied in white. Profile available in 6 metre lengths. Top as standard. Optional recess profile available.

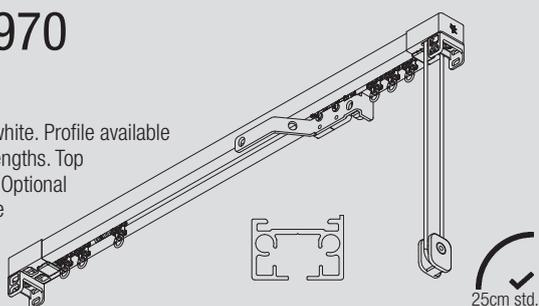

## SG 6370

Supplied in satin silver finish as standard. Profile available in 4, 5 and 6 metre lengths.

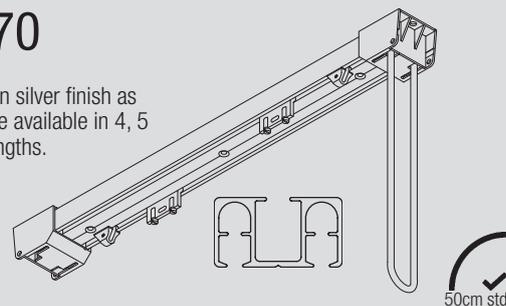

System Prices				Price
Specific lengths charged at the nearest 25cm increment above.				Ctgy.
<b>White</b>	<b>Wave</b>	<b>Wave</b>		
Standard	Roller	Roller		
Roller	Glider	Glider		
Gliders	60mm	80mm		
cm	£	£	£	
125	235.46	273.23	263.85	
150	253.18	305.69	293.06	
175	276.85	339.92	324.13	
200	294.58	372.39	353.34	
225	318.25	406.61	384.42	
250	335.98	439.08	413.63	
275	359.65	473.31	444.70	
300	377.38	505.78	473.91	
325	401.05	540.01	504.99	
350	418.77	572.47	534.19	
375	442.45	606.70	565.27	
400	460.17	639.17	594.48	
425	483.85	673.40	625.56	
450	501.57	705.87	654.76	
475	525.24	740.09	685.84	
500	542.97	772.56	715.05	
525	566.64	806.79	746.13	
550	584.37	839.26	775.33	
575	608.04	873.49	806.41	
600	625.77	905.95	835.62	

Prices above are for systems ready-assembled. Substantial savings can be made for self-assembly. Rail can be supplied in full lengths or cut-to-size with accessories separately.

Rail & Standard Accessories	Price
3004 Clamp, each, 10, 100.	
3090 Cord 100, metres, 500 metres.	
10854 Wave overlap support arm, white.	
11295 Endstop, white.	

3971 Profile, white 6m.	Price
10821 Overlap arm, bent, white.	
10826 Overlap arm support set.	
10840 2C Roller glider, at 10 per m, outer 10, 100.	
10852 Wave roller glider cord (80mm pitch), 6.5mm channel.	
10887 Wave overlap arm set.	
10869 Wave roller glider cord (60mm pitch), 6.5mm channel.	
10845 Wave master carrier, single stack 80mm.	
10923 Pan head screw M4X12.	
11314 Master carrier.	
11315 Guide set, white.	

10731 Cord retainer	
---------------------	--

Optional Accessories	Price
(additional charges may apply)	
3041 Bracket, each, 100.	
3582 Curtain hook, box, 100.	
Self-service sachets, 25 x 25.	
Outer, 20,000.	
6349 Wave® curtain tape.	
6363 Iron-on hemming tape.	
6365 Hanger.	
7002 Profile protector.	
10075 Lead weight 50 gr/m.	
10076 Fabric weight.	
10867 M4 x 16 screw.	
<b>Smart Fix Brackets in white, black or silver</b>	
11118 Smart Fix 60mm Bracket (11200 Set).	
11119 Smart Fix 80mm Bracket (11201 Set).	
11120 Smart Fix 100mm Bracket (11202 Set).	
11121 Smart Fix 120mm Bracket (11203 Set).	
11122 Smart Fix 150mm Bracket (11204 Set).	
11123 Smart Fix 200mm Bracket (11205 Set).	
<b>Square Smart Fix Brackets in white, black or silver</b>	
11139 Smart Fix 60mm Bracket (11210 Set).	
11140 Smart Fix 80mm Bracket (11211 Set).	
11141 Smart Fix 100mm Bracket (11212 Set).	
11142 Smart Fix 120mm Bracket (11213 Set).	
11143 Smart Fix 150mm Bracket (11214 Set).	
11144 Smart Fix 200mm Bracket (11215 Set).	
<b>Smart Fix Bracket Covers</b>	
11116 Smart Fix Bracket Cover.	
11137 Square Smart Fix Bracket Cover.	
<b>Universal Smart Fix Extension Bracket in white, black or silver</b>	
11154 Universal Smart Fix 120mm.	
11155 Universal Smart Fix 150mm.	
11156 Universal Smart Fix 200mm.	

5118 Wedge for recess profile.	
10820 Overlap arm, straight, white.	
10831 Connecting bridge.	
10862 Recess profile, white, per metre.	
10864 Recess mask, belt return, white.	
10865 Mounting support plate.	

Recess Profile White and Accessories	Price	
Charged at the nearest 25cm increment above.		
Add to price	Per Metre	Per Length
White	£48.17	£9.10

Tools	Price
7246 Notching tool for recess profile 10862	

Bending	Max. trade discount
	25%
For each bend add the following to above system price:	
Radius/cm	
25-99	£166.50 each.
Standard radius 25cm	
Over 99	£313.00 each.

Note: If using recess profile add an additional 20% to the relevant bending charge above. Please note: Standard radius for 3970 is 25cm. Standard minimum radius with recess profile is 50cm

System Prices	Price
Specific lengths charged at the nearest 25cm increment above.	
<b>Satin Silver</b>	
cm	£
300	419.55
350	464.10
400	508.73
450	553.30
500	597.89
550	642.49
600	687.09
650	731.70
700	776.25
750	820.87
800	865.41
850	910.02
900	954.61
950	999.22
1000	1043.81
1050	1088.41
1100	1132.98
1150	1177.52
1200	1222.17
1250	1266.73
1300	1311.34
1350	1355.90
1400	1400.54
1450	1445.10
1500	1489.68

Connecting bridge included over 6m. Right hand pull as standard.

Above prices are for systems ready-assembled. Substantial savings can be made for self-assembly. Rail can be supplied in full lengths or cut-to-size with accessories separately.

Rail and Standard Accessories	Price
6070 Cord.	
6214 Adjustable pilot runner.	
6227 Master pilot runner.	
6371 Silver rail available in 4m, 5m, 6m or cut-to-size.	
6377 End piece set.	

28C Screw countersunk, No. 8 2"/50mm.	
6086 Spring stop.	
6098 Roller glider with eye. 10 per metre.	

10731 Cord retainer	
---------------------	--

Special Lengths charged at the nearest 50cm increment above.

Optional Accessories	Price
(additional charges may apply)	
6079 Overlap arm.	
6376 Connecting bridge.	
3599 Nylon hook.	
6283 Roller glider.	
6369 Insert (Face Fix).	
<b>Universal Smart Fix Extension Bracket in white or silver</b>	
11154 Universal Smart Fix 120mm.	
11155 Universal Smart Fix 150mm.	
11156 Universal Smart Fix 200mm.	

Colours	Price
Other colours special order - see Page 74.	E

Bending	Max. trade discount
	25%
Standard right angle £142.00 each. Standard radius 50cm.	
Semi-circle or gradual curve £420.00 each.	

All prices shown exclude VAT

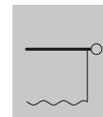

# Pole Systems – Metropole

## SG 7600 (SG 1003)

A decorative curtain pole concept combining beautifully crafted design details with contemporary finishes on our pole systems 7600/7610/7620/7630/7640 and 7650.

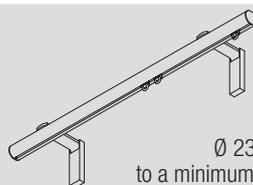

Hand operated,  
Ø 23mm, can be bent  
to a minimum radius of 15cm.

Assembled systems below includes Smart Fix Set 11206 as standard.  
All bent poles are supplied with Smart Fix Set 11209 as standard.  
For additional bracket options please see page 22.



Metropole by Silent Gliss is based around our pole systems 7600/7610/7620 (hand drawn), 7630/7640 (cord drawn) and 7650 (electric). Select desired pole combination from our pole catalogue and find price below.

### SG 7600 (SG 1003) HAND DRAWN Ø 23mm – SILVER/WHITE/MATT WHITE/ECRU

Price Category A

Size cm	125	150	175	200	225	250	275	300	325	350	375	400	425	450	475	500	525	550	575	600
Endcap - Flush/Stud	97.69	114.68	131.71	148.75	165.73	182.78	199.81	216.83	233.83	250.89	267.92	284.89	301.97	318.95	335.99	352.99	370.01	387.06	404.10	421.12
*Ball End	187.05	204.04	221.06	238.11	255.09	272.13	289.17	306.19	323.18	340.25	357.27	374.24	391.33	408.31	425.35	442.35	459.37	476.42	493.46	510.47
*Spear Finial	157.66	174.66	191.68	208.72	225.71	242.75	259.78	276.81	293.80	310.87	327.89	344.86	361.95	378.93	395.96	412.97	429.99	447.03	464.08	481.09
*Groove Cylinder	154.06	171.05	188.08	205.12	222.10	239.15	256.18	273.20	290.20	307.26	324.29	341.26	358.34	375.32	392.36	409.36	426.39	443.43	460.47	477.49
*Design End Cap	128.54	145.53	162.55	179.60	195.52	213.62	230.66	247.68	264.67	281.74	298.76	315.73	332.82	349.80	366.78	383.84	400.86	417.91	434.95	451.96
*Clear Ball	218.64	235.63	252.66	269.70	286.69	303.72	320.76	337.78	354.77	371.85	388.86	405.83	422.92	439.90	456.96	473.95	490.98	508.01	525.05	542.06
*Ellipse	138.44	155.43	172.45	189.50	206.48	223.52	240.56	257.58	274.57	291.64	308.66	325.63	342.72	359.70	376.73	393.74	410.76	427.81	444.85	461.86
*Taper	126.01	143.00	160.03	177.07	194.05	211.10	228.13	245.16	262.15	279.21	296.24	313.21	330.30	347.28	364.31	381.31	398.34	415.38	432.43	449.44

### SG 7600 (SG 1003) HAND DRAWN Ø 23mm – GUNMETAL/CHARCOAL/CHROME

Size cm	125	150	175	200	225	250	275	300	325	350	375	400	425	450	475	500	525	550	575	600
Endcap - Flush/Stud	113.37	134.79	156.12	177.47	198.79	220.17	241.53	262.83	284.15	305.52	326.84	348.24	369.57	390.97	412.29	433.64	454.98	476.34	497.67	519.06
*Ball End	202.73	224.15	245.47	266.82	288.15	309.53	330.89	352.19	373.51	394.88	416.20	437.60	458.93	480.33	501.65	522.99	544.34	565.7	587.03	608.42
*Spear Finial	173.34	194.76	216.09	237.44	258.77	280.15	301.51	322.80	344.13	365.50	386.82	408.22	429.54	450.95	473.13	493.61	514.96	536.32	557.64	579.04
*Groove Cylinder	169.74	191.16	212.49	233.84	255.16	276.54	297.90	319.20	340.53	361.89	383.21	404.61	425.94	447.34	468.66	490.01	511.35	532.71	554.04	575.43
*Design End Cap	144.21	165.64	186.96	208.31	229.64	251.02	282.28	293.67	315.00	336.37	357.69	379.09	400.42	421.82	443.13	464.48	485.83	507.19	528.52	549.91
*Clear Ball	234.31	255.74	277.06	298.42	319.75	341.12	362.48	383.78	405.11	426.48	447.80	469.20	490.53	511.92	533.24	554.58	575.93	597.29	618.62	640.01
*Ellipse	154.11	175.54	196.86	205.79	227.12	260.92	282.28	303.57	324.90	346.27	367.59	388.99	410.32	431.72	453.03	474.38	495.73	517.09	538.42	559.81
*Taper	141.69	163.11	184.44	205.79	227.12	248.50	269.85	291.15	312.48	333.85	355.16	376.57	397.89	419.29	440.61	461.96	483.31	504.67	525.99	547.38

The above pricing includes standard glider (11301). For alternatives add the relevant price supplement below.

### SG 7600 (SG 1003) GLIDER-SUPPLEMENTS

Size cm	125	150	175	200	225	250	275	300	325	350	375	400	425	450	475	500	525	550	575	600	
<b>Wave™ Standard Supplement</b>																					
60mm Glider-cord	23.17	27.79	32.43	37.07	41.69	46.33	50.95	55.59	60.21	64.86	69.50	74.12	78.76	83.38	88.02	92.64	97.28	101.93	106.55	111.19	
80mm Glider-cord	18.96	22.97	26.44	29.89	33.92	37.37	41.38	44.85	48.30	52.33	55.78	59.23	63.26	66.71	70.74	74.19	77.66	81.66	85.11	88.58	
<b>Enhanced Wave Supplement (with added optional extra)</b>																					
Please add the following to the above 80mm prices)																					
<b>Option 1: 2256 Adjustable Brake</b>				<b>Option 2: 2255 Adjustable Brake &amp; 6366 Carrier</b>				<b>Option 3: Enhanced Wave (80mm only)</b>													
Single Stack: £8.85    Pair Stack: £17.69				Single Stack: £17.97    Pair Stack: £35.92				Single Stack: £33.34    Pair Stack: £66.71													

Bending (Max. trade discount 33⅓%) Angle bend: £36.50 each. Standard radius 15cm. Semi-circle or gradual curve: £57.00 each.  
All bent poles are supplied with Smart Fix extension bracket set 11209.

\* Finials not available in chrome or silver

All prices shown exclude VAT



## Pole Systems – Metropole

### SG 7610 (SG 6130)

A decorative curtain pole concept combining beautifully crafted design details with contemporary finishes on our pole systems 7600/7610/7620/7630/7640 and 7650.

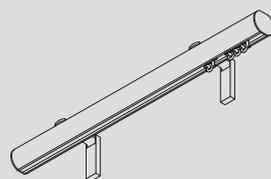

Hand operated, Ø 30mm can be bent to a minimum radius of 30cm

Assembled systems below includes Smart Fix Set 11206 as standard.

All bent poles are supplied with Smart Fix Set 11209 as standard.

For additional bracket options please see page 22.



#### SG 7610 (SG 6130) HAND DRAWN Ø 30mm – SILVER\*/BLACK/WHITE/MATT WHITE/ECRU

Price Category A

Size (cm)	125	150	175	200	225	250	275	300	325	350	375	400	425	450	475	500	525	550	575	600
Endcaps Flush/Stud	122.85	140.47	157.99	175.54	193.14	210.72	228.20	245.77	263.25	280.88	289.45	315.92	333.47	351.02	368.58	386.11	403.62	421.19	438.73	456.30
*Ball End	219.82	237.44	254.96	272.52	290.12	307.68	325.17	342.74	360.22	377.85	386.42	412.89	430.43	448.00	465.55	483.08	500.57	518.16	535.70	553.28
*Spear Finial	217.44	235.04	252.60	270.13	287.74	305.29	322.77	340.36	357.85	375.47	384.05	410.51	428.05	445.61	463.18	480.71	498.19	515.80	533.34	550.90
*Groove Cylinder	191.78	209.39	226.91	244.46	262.06	279.64	297.12	314.69	332.17	349.80	358.38	384.84	402.39	419.94	437.50	455.03	472.54	490.11	507.66	525.22
*Design Endcap	165.40	183.02	200.55	218.11	235.70	253.27	270.75	288.31	305.80	323.45	332.01	358.46	376.01	393.57	411.12	428.66	446.16	463.74	481.29	498.86
*Clear Ball	251.21	268.83	286.37	303.90	321.51	339.07	356.55	374.13	391.62	409.26	417.83	444.27	461.83	479.37	496.94	514.47	531.96	549.56	567.11	584.66
*Ellipse	180.28	197.90	215.42	232.97	250.57	268.15	285.63	303.20	320.68	338.31	346.89	373.35	390.90	408.45	426.01	443.54	461.05	478.62	496.16	513.73
*Taper	155.04	172.65	190.17	207.72	225.26	242.80	260.38	277.95	295.43	313.06	321.64	348.10	365.65	383.20	400.76	418.29	435.80	453.37	470.92	488.48

#### SG 7610 (SG 6130) HAND DRAWN Ø 30mm – CHROME (max 4m length)/GUNMETAL/BRONZE/ANTIQUE BRONZE/SAND/TAUPE/ANODIC GREY/CHARCOAL/SLATE GREY/OCHRE

Size (cm)	125	150	175	200	225	250	275	300	325	350	375	400	425	450	475	500	525	550	575	600
Endcaps Flush/Stud	149.71	172.62	195.60	218.42	241.36	264.27	287.18	310.06	333.04	355.93	378.80	401.76	424.69	447.53	470.54	493.39	516.28	539.17	562.10	585.04
*Ball End	246.68	269.59	292.57	315.39	338.33	361.25	384.14	407.02	430.01	452.90	475.77	498.74	521.67	544.5	567.51	590.37	613.25	636.14	659.06	682.00
*Spear Finial	244.30	267.22	290.19	313.02	335.95	358.86	381.77	404.63	427.64	450.51	473.40	496.37	519.28	542.13	565.13	587.99	610.88	633.75	656.68	679.61
*Groove Cylinder	218.64	241.54	264.52	287.34	310.28	333.19	356.10	378.98	401.96	424.85	447.72	470.68	493.61	516.45	539.47	562.31	585.20	608.09	631.02	653.96
*Design Endcap	192.28	215.17	238.16	260.98	283.92	306.82	329.71	352.62	375.59	398.49	421.35	444.32	467.25	490.08	513.09	535.96	558.84	581.72	604.63	627.59
*Clear Ball	278.09	300.98	323.96	346.80	369.74	392.63	415.53	438.43	461.41	484.29	507.17	530.13	553.07	575.89	598.91	621.76	644.64	667.54	690.44	713.41
*Ellipse	207.15	230.05	253.03	275.85	298.79	321.70	344.61	367.49	390.47	413.36	436.23	459.19	482.12	504.96	527.98	550.82	573.71	596.60	619.53	642.47
*Taper	181.90	204.80	227.78	250.61	273.54	296.45	319.36	342.24	365.22	388.11	410.98	433.94	456.87	479.71	502.73	525.57	548.47	571.35	594.28	617.22

The above pricing includes standard glider (11301). For alternatives add the relevant price supplement below.

#### SG 7610 (SG 6130) GLIDER-SUPPLEMENTS

Size cm	125	150	175	200	225	250	275	300	325	350	375	400	425	450	475	500	525	550	575	600	
Roller-Glider Supplement	22.19	26.63	31.07	35.51	39.94	44.38	48.82	53.26	57.70	62.13	66.57	71.01	75.45	79.89	84.32	88.76	93.20	97.64	102.08	106.52	
Wave™ Standard Supplement																					
60mm Glider-cord	23.17	27.79	32.43	37.07	41.69	46.33	50.95	55.59	60.21	64.86	69.50	74.12	78.76	83.38	88.02	92.64	97.28	101.93	106.55	111.19	
80mm Glider-cord	18.96	22.97	26.44	29.89	33.32	37.37	41.38	44.85	48.30	52.33	55.78	59.23	63.26	66.71	70.74	74.19	77.66	81.66	85.11	88.58	
Enhanced Wave Supplement (with added optional extras)																					
Please add the following to the above 80mm wave prices.																					
Option 1: 2256 Adjustable Brake						Option 2: 2255 Adjustable Brake & 6366 Carrier						Option 3: Enhanced Wave (80mm only)									
Single Stack: £8.85 Pair Stack: £17.69						Single Stack: £17.97 Pair Stack: £35.92						Single Stack: £33.34 Pair Stack: £66.71									
Wave Roller-Glider																					
Supplement (80mm)	84.65	101.58	118.52	135.44	152.37	169.31	186.23	203.17	220.10	237.27	253.96	270.89	287.81	304.75	321.68	338.62	355.54	372.47	389.40	406.33	

Internal connecting bridge 6635 £23.22 each.

Bending 7610 (Max trade discount 33¼%). Angle bend £82.00 each. Standard radius 30cm. Semi circle or gradual curve £111.50 each.

All bent poles are supplied with Smart Fix extension bracket set 11209.

\* Finials are not available in chrome or silver

\*\* When a Metropole is ordered in black, the standard glider will also be supplied in black (as of 1st April 2023).

All prices shown exclude VAT



# Pole Systems – Metropole

## SG 7620 (SG 6140)

A decorative curtain pole concept combining beautifully crafted design details with contemporary finishes on our pole systems 7600/7610/7620/7630/7640 and 7650.

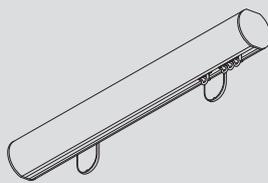

Assembled systems below includes 20334 maxi adjustable bracket as standard, including bent poles.

Hand operated, Ø 50mm can be bent to a minimum radius of 50cm



50cm std.

### SG 7620 (SG 6140) HAND DRAWN Ø 50mm – SILVER/BLACK/WHITE/MATT WHITE/ECRU

Price Category A

Size (cm)	125	150	175	200	225	250	275	300	325	350	375	400	425	450	475	500	525	550	575	600
Endcap Flush/Stud	236.44	275.78	304.72	333.64	372.99	401.89	441.26	470.17	499.09	538.42	567.33	596.28	635.66	664.55	703.91	732.79	761.74	801.04	830.46	858.91
*Ball End	428.17	467.49	496.43	525.35	564.72	593.60	632.97	661.89	690.81	730.14	759.06	787.99	827.37	856.26	895.63	924.51	953.45	992.76	1022.19	1050.63
*Spear Finial	516.79	556.13	585.07	613.98	653.34	682.24	721.61	750.52	779.44	818.77	847.68	876.63	916.01	944.89	984.26	1013.14	1042.09	1081.39	1110.81	1139.26
*Groove Cylinder	384.82	424.16	453.10	482.01	521.37	550.27	589.64	618.55	647.47	686.80	715.71	744.66	784.04	812.92	852.29	881.17	910.12	949.42	978.84	1007.29
*Design Endcap	296.82	336.16	365.10	394.01	433.37	462.27	501.63	530.55	559.47	588.39	627.71	656.66	696.04	724.92	764.29	793.17	822.11	861.42	890.83	919.29
*Clear Ball	479.71	519.06	548.00	576.93	616.26	645.17	684.53	713.46	742.36	781.71	810.61	839.57	878.93	907.83	947.19	976.08	1005.02	1044.34	1073.75	1102.21
*Ellipse	463.62	502.96	531.90	560.81	600.17	629.07	668.44	697.35	726.27	765.60	794.51	823.46	862.84	891.73	931.09	959.97	988.92	1028.22	1057.64	1086.09
*Taper	389.22	428.56	457.50	486.42	525.77	554.67	594.04	622.95	651.87	691.20	720.11	749.06	788.44	817.33	856.69	885.57	914.52	953.82	983.24	1011.69

### SG 7620 (SG 6140) HAND DRAWN Ø 50mm – TAUPE/ANTIQUÉ BRONZE/ANODIC GREY/SLATE GREY/BRONZE

Size (cm)	125	150	175	200	225	250	275	300	325	350	375	400	425	450	475	500	525	550	575	600
Endcap Flush/Stud	338.25	386.89	424.83	462.92	511.45	549.54	598.07	636.16	674.22	722.73	760.82	798.90	847.46	885.57	934.06	972.16	1010.19	1058.77	1096.85	1134.90
Ball End	529.96	578.61	616.54	654.63	703.17	741.26	789.80	827.88	865.94	914.46	952.52	990.61	1039.17	1077.29	1125.77	1163.89	1201.91	1250.49	1288.56	1326.64
Spear Finial	618.59	667.24	705.18	743.27	791.80	829.88	878.42	916.51	954.57	1003.08	1041.16	1079.25	1127.81	1165.92	1214.41	1252.51	1290.54	1339.12	1377.19	1415.25
Groove Cylinder	486.62	535.27	573.21	611.30	659.83	697.91	746.45	784.54	822.60	871.11	909.19	947.28	995.84	1033.95	1082.44	1120.54	1158.57	1207.15	1245.22	1283.28
Design Endcap	398.62	447.27	485.20	523.30	571.83	609.91	658.45	696.54	734.60	783.11	821.19	859.28	907.84	945.94	994.44	1032.54	1070.57	1119.15	1157.22	1195.28
Clear Ball	581.54	630.17	668.10	706.20	754.74	792.82	841.36	879.44	917.50	966.01	1004.10	1042.19	1090.74	1128.84	1177.33	1215.44	1253.48	1302.06	1340.12	1378.19
Ellipse	565.43	614.07	652.01	690.10	738.63	776.72	825.25	863.34	901.40	939.46	987.99	1026.08	1074.64	1112.75	1161.24	1199.34	1237.37	1285.95	1324.02	1362.08
Taper	491.03	539.67	577.61	615.70	664.23	702.32	750.85	788.94	827.00	875.51	913.60	951.68	1000.24	1038.35	1086.84	1124.94	1162.97	1211.55	1249.63	1287.68

The above pricing includes standard glider (11301). For alternatives add the relevant price supplement below.

### SG 7620 (SG 6140) GLIDER – SUPPLEMENTS

Size (cm)	125	150	175	200	225	250	275	300	325	350	375	400	425	450	475	500	525	550	575	600
Roller-Glider Supplement	22.19	26.63	31.07	35.51	39.94	44.38	48.82	53.26	57.70	62.13	66.57	71.01	75.45	79.89	84.32	88.76	93.20	97.64	102.08	106.52
Wave*Standard Supplement																				
60mm Glider-cord	23.17	27.79	32.43	37.07	41.69	46.33	50.95	55.59	60.21	64.86	69.50	74.12	78.76	83.38	88.02	92.64	97.28	101.93	106.55	111.19
80mm Glider-cord	18.96	22.97	26.44	29.89	33.92	37.37	41.38	44.85	48.30	52.33	55.78	59.23	63.26	66.71	70.74	74.19	77.66	81.66	85.11	88.58
Enhanced Wave Supplement																				
Please add the following to the above 80mm wave prices.																				
Option 1: 2256 Adjustable Brake																				
Single Stack: £8.85																				
Pair Stack: £17.69																				
Option 2: 2255 Adjustable Brake & 6366 Carrier																				
Single Stack: £17.97																				
Pair Stack: £35.92																				
Option 3: Enhanced Wave (80mm only)																				
Single Stack: £33.34																				
Pair Stack: £66.71																				
Wave Roller-Glider Supplement (80mm)*	84.65	101.58	118.52	135.44	152.37	169.31	186.23	203.17	220.10	237.27	253.96	270.89	287.81	304.75	321.68	338.62	355.54	372.47	389.40	406.33

\*Not for use on bent 50mm poles

7620 Connecting Bridge, 11783 see parts list for prices.  
Bending (Max. trade discount 33% ) Angle bend: £90.50 each. Standard radius 50cm. Semi-circle or gradual curve: £121.00 each.  
Bent tracks not compatible with 6099 Wave Roller Glider.

\* Finials are not available in silver

\*\* When a Metropole is ordered in black, the standard glider will also be supplied in black (as of 1st April 2023).

All prices shown exclude VAT



# Pole Systems – Metropole

## SG 7630 (SG 6120)

A decorative curtain pole concept combining beautifully crafted design details with contemporary finishes on our pole systems 7600/7610/7620/7630/7640 and 7560.

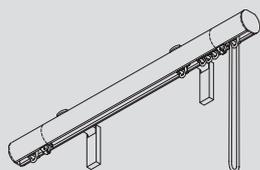

Cord operated, Ø 30mm can be bent to a minimum radius of 30cm

Assembled systems below includes Smart Fix Set 11206 as standard.

All bent poles are supplied with Smart Fix Set 11209 as standard.

For additional bracket options please see page 22.

All bent poles are supplied with adjustable brackets.



30cm std.

### SG 7630 (SG 6120) CORD DRAWN Ø 30mm – BLACK/WHITE/MATT WHITE/ECRU

Price Category A

Size cm	125	150	175	200	225	250	275	300	325	350	375	400	425	450	475	500	525	550	575	600
Flush/Stud Endcap	214.78	237.37	260.12	282.78	305.41	328.14	350.76	373.17	396.14	418.78	441.46	464.13	486.81	509.46	532.15	554.81	577.47	600.13	622.82	645.48
Ball End	311.72	334.33	357.08	379.73	402.37	425.11	447.72	470.14	493.12	515.75	538.42	561.10	583.77	606.43	629.12	651.78	674.44	697.10	719.80	742.46
Spear Finial	309.35	331.96	354.71	377.36	399.99	422.72	445.35	467.77	490.73	513.37	536.03	558.70	581.40	604.05	626.73	649.39	672.04	694.70	717.41	740.07
Groove Cylinder	283.70	306.29	329.05	351.70	374.33	397.07	419.69	442.09	465.06	487.71	510.38	533.05	555.73	578.38	601.07	623.74	646.39	669.05	691.75	714.40
Design Endcap	257.33	279.91	302.66	325.31	347.97	370.70	393.32	415.72	438.68	461.33	484.02	506.69	529.36	552.01	574.68	597.36	620.02	642.69	665.37	688.04
Clear Ball	343.13	365.71	388.46	411.13	433.77	456.52	479.13	501.53	524.50	547.16	569.81	592.51	615.19	637.82	660.50	683.16	705.83	728.49	751.20	773.83
Ellipse	272.21	294.80	317.55	340.21	362.84	385.58	408.20	430.60	453.57	476.22	498.89	521.56	544.24	566.89	589.58	612.25	634.90	657.56	680.26	702.91
Taper	246.96	269.55	292.31	314.96	337.59	360.33	382.95	405.35	428.32	450.97	473.64	496.31	518.99	541.64	564.33	587.00	609.65	632.31	655.01	677.66

### SG 7630 (SG 6120) CORD DRAWN Ø 30mm – OCHRE/GUNMETAL/BRONZE/ANTIQUE BRONZE/SAND/TAUPE/ANODIC GREY/CHARCOAL/SLATE GREY/CHROME (max 4m length)

Size cm	125	150	175	200	225	250	275	300	325	350	375	400	425	450	475	500	525	550	575	600
Flush/Stud Endcap	243.17	271.60	299.92	328.30	356.65	385.05	413.43	441.71	470.09	498.45	526.85	555.21	583.52	611.87	640.34	668.63	696.98	725.35	753.72	782.06
*Ball End	340.14	368.57	396.99	425.27	453.63	482.01	510.40	538.69	567.06	595.42	623.81	652.19	680.49	708.85	737.30	765.59	793.96	822.32	850.69	879.04
*Spear Finial	337.76	366.19	394.51	422.89	451.23	479.63	508.03	536.31	564.68	593.03	621.43	649.80	678.10	706.47	734.92	763.20	791.58	819.94	848.31	876.64
*Groove Cylinder	312.10	340.53	368.84	397.22	425.57	453.97	482.35	510.63	539.01	568.44	595.77	624.13	652.44	680.80	709.26	737.55	765.90	794.27	822.64	850.98
*Design Endcap	285.73	314.15	342.45	370.84	399.19	427.59	455.99	484.26	512.64	541.00	569.40	597.77	626.07	654.42	682.87	711.16	739.54	767.89	796.26	824.60
*Clear Ball	371.54	399.97	428.28	456.67	485.00	513.40	541.79	570.08	598.47	626.83	655.19	683.58	711.87	740.25	768.68	796.97	825.34	853.71	882.08	910.42
*Ellipse	300.61	329.03	357.35	385.73	414.08	442.48	470.86	499.14	527.52	555.89	584.28	612.64	640.95	669.31	697.77	726.06	754.41	782.78	811.15	839.49
*Taper	275.36	303.79	332.10	360.48	388.83	417.23	445.61	473.89	502.27	530.64	559.03	587.39	615.70	644.06	672.52	700.81	729.16	757.53	785.91	814.24

The above pricing includes standard glider (11301). For alternative glider options including wave and roller glider, please add the relevant price supplement below.

### SG 7630 (SG 6120) GLIDER-SUPPLEMENTS

Size cm	125	150	175	200	225	250	275	300	325	350	375	400	425	450	475	500	525	550	575	600	
Roller-Glider Supplement	22.19	26.63	31.07	35.51	39.94	44.38	48.82	53.26	57.70	62.13	66.57	71.01	75.45	79.89	84.32	88.76	93.20	97.64	102.08	106.52	
Wave™ Standard Supplement																					
60mm Glider-cord	23.17	27.79	32.43	37.07	41.69	46.33	50.95	55.59	60.21	64.86	69.50	74.12	78.76	83.38	88.02	92.64	97.28	101.93	106.55	111.19	
80mm Glider-cord	18.96	22.97	26.44	29.89	33.92	37.37	41.38	44.85	48.30	52.33	55.78	59.23	63.26	66.71	70.74	74.19	77.66	81.66	85.11	88.58	
Enhanced Wave Supplement (Please add the following to the above 80mm wave prices)																					
Single Stack: £21.15    Pair Stack: £42.33																					
Wave Roller-Glider Supplement (80mm)	84.65	101.58	118.52	135.44	152.37	169.31	186.23	203.17	220.10	237.27	253.96	270.89	287.81	304.75	321.68	338.62	355.54	372.47	389.40	406.33	

- Includes 1 x 10731 Cord retainer

Bending (Max. trade discount 33⅓%) Angle bend: £86.00 each. Standard radius 30cm. Semi-circle or gradual curve: £116.50 each.

All bent poles are supplied with Smart Fix extension bracket set 11209.

Intermediate pulley 11663, see parts list for prices.

\* Finials are not available in chrome

\*\* When a Metropole is ordered in black, the standard glider will also be supplied in black (as of 1st April 2023).

All prices shown exclude VAT

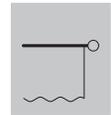

# Pole Systems – Metropole

## SG 7640 (SG 6160)

A decorative curtain pole concept combining beautifully crafted design details with contemporary finishes on our pole systems 7600/7610/7620/7630/7640 and 7650.

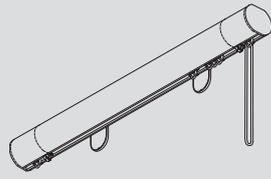

Cord operated, Ø 50mm  
can be bent to a minimum  
radius of 60cm

Assembled systems below  
includes 20334 maxi adjustable  
bracket as standard, including  
bent poles.



### SG 7640 (SG 6160) CORD DRAWN Ø 50mm – \*BLACK/WHITE/MATT WHITE/ECRU

Price Category A

Size (cm)	125	150	175	200	225	250	275	300	325	350	375	400	425	450	475	500	525	550	575	600
Endcap Flush/Stud	362.09	404.27	435.98	467.68	509.84	541.58	583.71	615.44	647.14	689.30	721.01	752.73	794.92	826.60	868.77	900.50	932.22	974.37	1006.07	1037.80
Ball End	553.81	595.99	627.68	659.39	701.56	733.29	775.43	807.17	838.85	881.02	912.72	944.46	986.63	1018.32	1060.48	1092.20	1123.92	1166.08	1197.79	1229.50
Spear Finial	642.43	684.62	716.33	748.03	790.19	821.92	864.06	895.78	927.49	969.65	1001.36	1033.08	1075.26	1106.95	1149.11	1180.85	1212.57	1254.72	1286.42	1318.15
Groove Cylinder	510.46	552.65	584.36	616.06	658.22	689.95	732.09	763.81	795.52	837.68	869.39	901.11	943.29	974.98	1017.14	1048.88	1080.60	1122.75	1154.45	1186.18
Design Endcap	422.46	464.65	496.36	528.06	570.22	601.95	644.09	675.81	707.52	749.67	781.39	813.10	855.29	886.98	929.14	960.88	992.59	1034.75	1066.44	1098.18
Clear Ball	605.39	647.54	679.26	710.96	753.12	784.87	826.99	858.73	890.42	932.59	964.28	996.03	1038.20	1069.89	1112.06	1143.77	1175.51	1217.63	1249.36	1281.07
Ellipse	589.26	631.45	663.16	694.86	737.02	768.75	810.89	842.09	874.32	916.48	948.19	979.91	1022.09	1053.78	1095.94	1127.68	1159.40	1201.55	1233.25	1264.98
Taper	514.87	557.05	588.76	620.46	662.62	694.36	736.49	768.22	799.92	842.08	873.79	905.51	947.70	979.38	1021.55	1053.28	1085.00	1127.15	1158.85	1190.58

### SG 7640 (SG 6160) CORD DRAWN Ø 50mm – TAUPE/ANTIQU BRONZE/ANODIC GREY/SLATE GREY/BRONZE

Size (cm)	125	150	175	200	225	250	275	300	325	350	375	400	425	450	475	500	525	550	575	600
Endcap Flush/Stud	446.37	495.66	534.51	573.41	622.74	661.57	710.89	749.79	788.65	837.94	876.81	915.71	964.99	1003.85	1053.19	1092.07	1130.89	1180.23	1219.11	1257.98
Ball End	638.08	687.38	726.24	765.13	814.45	853.28	902.61	941.51	980.37	1029.65	1068.54	1107.42	1156.7	1195.57	1245.16	1283.78	1322.62	1371.95	1410.82	1449.70
Spear Finial	726.71	776	814.85	853.76	903.09	941.92	991.24	1030.14	1069	1118.29	1157.16	1196.06	1245.34	1284.2	1333.54	1372.41	1411.24	1460.57	1499.45	1538.33
Groove Cylinder	594.74	644.03	682.88	721.79	771.12	809.95	859.27	898.49	937.03	986.32	1025.19	1064.09	1113.37	1152.23	1201.57	1240.44	1279.27	1328.6	1367.48	1406.75
Design Endcap	506.74	557.09	594.88	633.78	683.12	721.94	771.27	810.17	849.03	898.32	937.19	976.09	1025.37	1064.23	1113.57	1152.44	1191.27	1240.6	1279.48	1318.35
Clear Ball	689.63	738.92	777.77	816.67	866	904.83	954.15	993.05	1031.91	1081.2	1120.07	1158.97	1208.25	1247.11	1296.45	1335.33	1374.15	1423.49	1462.37	1501.24
Ellipse	673.55	722.84	761.68	800.59	849.92	888.75	938.07	976.97	1015.83	1065.12	1103.99	1142.89	1192.17	1231.03	1280.37	1319.24	1358.07	1407.4	1446.29	1485.16
Taper	599.15	648.44	687.29	726.19	775.52	814.35	863.67	902.57	941.43	990.72	1029.59	1068.49	1117.77	1156.63	1205.97	1244.85	1283.67	1333.01	1371.89	1410.76

The above pricing includes standard glider (11301). For alternatives add the relevant price supplement below.

### SG 7640 (SG 6160) GLIDER – SUPPLEMENTS

Size	125	150	175	200	225	250	275	300	325	350	375	400	425	450	475	500	525	550	575	600	
Roller-Glider Supplement	22.19	26.63	31.07	35.51	39.94	44.38	48.82	53.26	57.70	62.13	66.57	71.01	75.45	79.89	84.32	88.76	93.20	97.64	102.08	106.52	
Wave™ Standard Supplement																					
60mm Glider-cord	23.17	27.79	32.43	37.07	41.69	46.33	50.95	55.59	60.21	64.86	69.50	74.12	78.76	83.38	88.02	92.64	97.28	101.93	106.55	111.19	
80mm Glider-cord	18.96	22.97	26.44	29.89	33.92	37.37	41.38	44.85	48.30	52.33	55.78	59.23	63.26	66.71	70.74	74.19	77.66	81.66	85.11	88.58	

#### Enhanced Wave Supplement

Please add the following to the above 80mm wave prices.

#### Enhanced Wave

Single Stack: £21.15 Pair Stack: £42.33

#### Wave Roller-Glider

Supplement (80mm) *	125	150	175	200	225	250	275	300	325	350	375	400	425	450	475	500	525	550	575	600
	84.65	101.58	118.52	135.44	152.37	169.31	186.23	203.17	220.10	237.27	253.96	270.89	287.81	304.75	321.68	338.62	355.54	372.47	389.40	406.33

\* Not for use on bent 50mm poles

7640 Intermediate Pulley 11664, see parts list for prices.

Bending (Max. trade discount 33 1/3%) Angle bend: £90.50 each. Standard radius 68cm. Semi-circle or gradual curve: £121.00 each.

Bent tracks not compatible with 6099 Wave Roller Glider.

\*When a Metropole is ordered in black, the standard glider will also be supplied in black (as of 1st April 2023).

All prices shown exclude VAT







# Pole Systems – Metropole

## Electric Metropole SG 7650 (SG 6150) System – 5600 Integral Receiver System

Price Category C

Table with columns for Pole Size (cm) from 125 to 600 and rows for various pole types including Silver/White, Anodic Grey, and Bronze. Each cell contains a numerical price value.

## Wave Roller Glider – SUPPLEMENT

Table showing supplementary prices for Wave Roller Glider across pole sizes from 125 to 600 cm. Prices are listed for 60/80mm and 80/110mm configurations.

\* Finales not available in silver
\*\* When a Metropole is ordered in black, the standard glider will also be supplied in black (as of 1st April 2023).

SG 7605 (SG 6100) Metropole
A 36mm deep flat profile
Assembled systems below includes Smart Fix Set 11206 as standard.
Bent poles are supplied with Smart Fix Set 11209 as standard.
For additional bracket options, please see page 22.
Image of a pole with a glider and a 20cm standard bend angle indicator.

## HAND DRAWN 36mm deep – WHITE/SILVER/\*BLACK/GUNMETAL/ANTIQU BRONZE/CHROME (max. length 3.95m)/

ANODIC GREY/CHARCOAL/SLATE GREY/MATT WHITE/BRONZE

Price Category A

Table showing prices for hand-drawn 36mm poles in various finishes across sizes from 125 to 600 cm.

The above pricing includes standard glider (11301). For alternatives add the relevant price supplement below.

## SG 7605 (SG 6100) GLIDER - SUPPLEMENTS

Table listing prices for glider supplements including Roller-Glider, Wave™ Standard, and Enhanced Wave. Includes options for adjustable brakes and enhanced waves.

Bending 7605 (Max. trade discount 33 1/2%) Angle bend: £35.50 each. Standard radius 20cm. Semi-circle or gradual curve: £47.50 each

Bending 7605 (max trade discount 33.33 %) Angle bend: £35.50 each. Standard radius 20cm. Semi-circle or gradual curve: £47.50 each.

\* When a Metropole is ordered in black, the standard glider will also be supplied in black (as of 1st April 2023).

All prices shown exclude VAT



# Pole Systems – Metropole Brackets

- 11125 Smart Fix 80mm Bracket (11207 Set)
- 11126 Smart Fix 100mm Bracket (11208 Set)
- 11216 Square Smart Fix 60mm Bracket Set
- 11217 Square Smart Fix 80mm Bracket Set
- 11218 Square Smart Fix 100mm Bracket Set
- 11472 Square Smart Fix Adjustable Bracket Set
- 20334 Maxi Adjustable Bracket
- 11668 Top Fix Bracket
- 11669 Fillet Bracket
- 6175 Mini Hanger

## Brackets

Price Category A

Bracket Supplements – Add the following supplement on to the system price if alternative brackets have been specified:

		11125 (11207 Set) Smart Fix 80mm		11126 (11208 Set) Smart Fix 100mm		6175 Mini Hanger			11669 Fillet Bracket (Add on pricing for 23mm, 36mm, 30mm)		11669 Fillet Brackets (Add on pricing to 50mm)	20334 Maxi Adjustable Bracket	11668 Top Fix Bracket	
		Colour		Colour		Colour			Colour		Colour	Colour	Colour	
Pole Size (cm)	No. of Brackets	Silver, Black, White, Matt White, Ecu, Gunmetal, Charcoal, Bronze, Antique Bronze, Anodic Grey, Slate Grey, Ochre, Sand, Taupe	Chrome Effect	Silver, Black, White, Matt White, Ecu, Gunmetal, Charcoal, Bronze, Antique Bronze, Anodic Grey, Slate Grey, Ochre, Sand, Taupe	Chrome Effect	Silver, White	Black, Gunmetal, Matt White, Charcoal, Ecu, Bronze, Antique Bronze, Anodic Grey, Slate Grey, Ochre, Sand, Taupe	Chrome Effect	Silver, Black, Gunmetal, White, Matt White, Charcoal, Ecu, Bronze, Antique Bronze, Anodic Grey, Slate Grey, Ochre, Sand, Taupe	Chrome Effect	Silver, Black, Gunmetal, White, Matt White, Charcoal, Ecu, Bronze, Antique Bronze, Anodic Grey, Slate Grey, Ochre, Sand, Taupe, Chrome	Silver, Black, Gunmetal, White, Matt White, Charcoal, Ecu, Bronze, Antique Bronze, Anodic Grey, Slate Grey, Ochre, Sand, Taupe	Silver, Black, Gunmetal, White, Matt White, Charcoal, Ecu, Bronze, Anodic Bronze, Anodic Grey, Slate Grey, Ochre, Sand, Taupe	Chrome Effect
125	3	3.31	1.81	6.95	10.21	69.45	99.28	102.01	113.55	92.67	27.72	105.87	44.98	£86.56
150	4	4.42	2.42	9.27	13.61	92.60	132.37	136.02	151.40	123.56	36.96	141.16	59.98	115.42
175	4	4.42	2.42	9.27	13.61	92.60	132.37	136.02	151.40	123.56	36.96	141.16	59.98	115.42
200	4	4.42	2.42	9.27	13.61	92.60	132.37	136.02	151.40	123.56	36.96	141.16	59.98	115.42
225	5	5.52	3.02	11.59	17.02	115.75	165.47	170.02	189.25	154.45	46.20	176.45	74.97	144.27
250	5	5.52	3.02	11.59	17.02	115.75	165.47	170.02	189.25	154.45	46.20	176.45	74.97	144.27
275	6	6.63	3.63	13.91	20.42	138.90	198.56	204.03	227.10	185.34	55.44	211.74	89.97	173.12
300	6	6.63	3.63	13.91	20.42	138.90	198.56	204.03	227.10	185.34	55.44	211.74	89.97	173.12
325	6	6.63	3.63	13.91	20.42	138.90	198.56	204.03	227.10	185.34	55.44	211.74	89.97	173.12
350	7	7.73	4.23	16.23	23.82	162.05	231.65	238.03	264.95	216.23	64.68	247.03	104.96	201.98
375	7	7.73	4.23	16.23	23.82	162.05	231.65	238.03	264.95	216.23	64.68	247.03	104.96	201.98
400	7	7.73	4.23	16.23	23.82	162.05	231.65	238.03	264.95	216.23	64.68	247.03	104.96	201.98
425	8	8.84	4.83	18.55	27.23	185.20	264.75	272.04	302.80	247.12	73.92	282.32	119.95	230.83
450	8	8.84	4.83	18.55	27.23	185.20	264.75	272.04	302.80	247.12	73.92	282.32	119.95	230.83
475	9	9.94	5.44	20.86	30.63	208.35	297.84	306.04	340.65	278.01	83.16	317.62	134.95	259.69
500	9	9.94	5.44	20.86	30.63	208.35	297.84	306.04	340.65	278.01	83.16	317.62	134.95	259.69
525	9	9.94	5.44	20.86	30.63	208.35	297.84	306.04	340.65	278.01	83.16	317.62	134.95	259.69
550	10	11.05	6.04	23.18	34.03	231.50	330.93	340.05	378.50	308.90	92.40	352.91	149.94	288.54
575	10	11.05	6.04	23.18	34.03	231.50	330.93	340.05	378.50	308.90	92.40	352.91	149.94	288.54
600	10	11.05	6.04	23.18	34.03	231.50	330.93	340.05	378.50	308.90	92.40	352.91	149.94	288.54

		11216 set (11145+11137) Square Smart Fix 60mm			11217 set (11146+11137) Square Smart Fix 80mm			11218 set (11147+11137) Square Smart Fix 100mm			11472 set (11483+11137) Square Smart Fix Adjustable		
		Colour			Colour			Colour			Colour		
Pole Size (cm)	No. of Brackets	Silver, White	Black, Matt White, Ecu, Gunmetal, Charcoal, Bronze, Antique Bronze, Anodic Grey, Slate Grey, Ochre, Sand, Taupe	Chrome Effect	Silver, White	Black, Matt White, Ecu, Gunmetal, Charcoal, Bronze, Antique Bronze, Anodic Grey, Slate Grey, Ochre, Sand, Taupe	Chrome Effect	Silver, White	Black, Matt White, Ecu, Gunmetal, Charcoal, Bronze, Antique Bronze, Anodic Grey, Slate Grey, Ochre, Sand, Taupe	Chrome Effect	White, Silver	Black, Matt White, Ecu, Gunmetal, Charcoal, Bronze, Antique Bronze, Anodic Grey, Slate Grey, Ochre, Sand, Taupe	Chrome Effect
125	3	16.24	21.20	31.18	17.87	22.82	32.63	20.16	25.12	34.11	19.66	24.65	53.40
150	4	21.65	28.26	41.58	23.82	30.43	43.50	26.88	33.49	45.48	26.21	32.86	71.20
175	4	21.65	28.26	41.58	23.82	30.43	43.50	26.88	33.49	45.48	26.21	32.86	71.20
200	4	21.65	28.26	41.58	23.82	30.43	43.50	26.88	33.49	45.48	26.21	32.86	71.20
225	5	27.07	35.33	51.97	29.78	38.04	54.38	33.60	41.86	56.84	32.76	41.08	88.99
250	5	27.07	35.33	51.97	29.78	38.04	54.38	33.60	41.86	56.84	32.76	41.08	88.99
275	6	32.48	42.39	62.37	35.73	45.65	65.25	40.32	50.24	68.21	39.31	49.29	106.79
300	6	32.48	42.39	62.37	35.73	45.65	65.25	40.32	50.24	68.21	39.31	49.29	106.79
325	6	32.48	42.39	62.37	35.73	45.65	65.25	40.32	50.24	68.21	39.31	49.29	106.79
350	7	37.89	49.46	72.76	41.69	53.26	76.13	47.04	58.61	79.58	45.86	57.51	124.59
375	7	37.89	49.46	72.76	41.69	53.26	76.13	47.04	58.61	79.58	45.86	57.51	124.59
400	7	37.89	49.46	72.76	41.69	53.26	76.13	47.04	58.61	79.58	45.86	57.51	124.59
425	8	43.31	56.52	83.16	47.65	60.86	87.01	53.76	66.98	90.95	52.42	65.73	142.39
450	8	43.31	56.52	83.16	47.65	60.86	87.01	53.76	66.98	90.95	52.42	65.73	142.39
475	9	48.72	63.59	93.55	53.60	68.47	97.88	60.48	75.35	102.32	58.97	73.94	160.19
500	9	48.72	63.59	93.55	53.60	68.47	97.88	60.48	75.35	102.32	58.97	73.94	160.19
525	9	48.72	63.59	93.55	53.60	68.47	97.88	60.48	75.35	102.32	58.97	73.94	160.19
550	10	54.13	70.66	103.95	59.56	76.08	108.76	67.20	83.73	113.69	65.52	82.16	177.99
575	10	54.13	70.66	103.95	59.56	76.08	108.76	67.20	83.73	113.69	65.52	82.16	177.99
600	10	54.13	70.66	103.95	59.56	76.08	108.76	67.20	83.73	113.69	65.52	82.16	177.99

\*Smart Fix bracket sets, 11207 and 11208 are supplied as standard at no additional charge for WAVE. Extension brackets can be coloured to suit Metropole (refer to page 74 for pricing).

All prices shown exclude VAT



# Shower Rail Systems

## SG 6100 SG 6103

SG 6101 rail in silver anodised finish.  
SG 6103 in white.

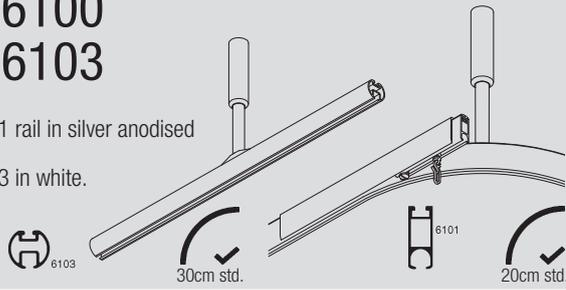

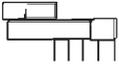
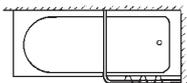
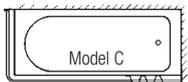
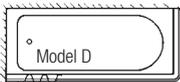
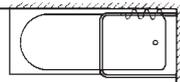
		Price Qty.	
Ready, complete, pre-packed with all accessories, including hanger rod(s) where applicable.			
System Prices			
		<b>6100 Silver</b>	<b>6103 White</b>
<b>Model A</b>	91cm 183cm 213cm 244cm	59.50 93.68 105.74 120.17	101.86 148.40 163.61 179.21
			
<b>Model B</b>	76cmx76cm 91cmx91cm	124.50 136.32	186.88 202.20
			
<b>Model C-left Model D-right</b>	168cmx76cm	158.75	233.45
			
<b>Model E</b>	91cmx76cm x91cm	222.85	284.47
			
Special shapes for Shower Rails Send template and drawings for quotation.			

Colours  
Special order – see Page 74.

### Bending for special shower rails

Max. trade discount

6101 Angle bend £25.50 Standard radius 20cm.  
Semi-circle or gradual curve £35.50  
6103 Angle bend £63.50 Standard radius 30cm  
Semi-circle or gradual curve £84.50

33 1/3%

All prices shown  
exclude VAT

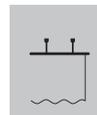

# Cubicle, Room Divider Systems

Hospital Cubicle System available through approved Distributors only.

## SG 6100

Hospital Cubicle Safety Device System available through approved Distributors only – use in conjunction with System 6100

## SG 6650

## SG 6103

Supplied in satin silver finish and white in 6 metre lengths.

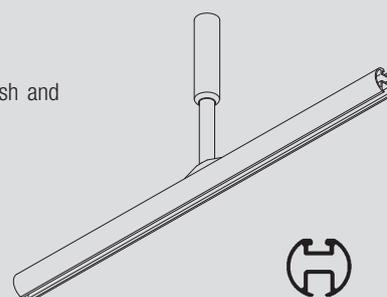

	Price Ctg.
<b>Accessories</b>	<b>A</b>
6101 Rail, silver, white. Available in following lengths: 4.5m, 5.0m, 5.5m, 6.0m, 6.75m. Available in silver only.	
6094 Roller glider with hook, 10, 100.	
6096 Strip glider. Outer, 1,000.	
6098 Roller glider with eye, 10, 100.	
6110 Dustcover for 6101, white, m.	
6124 Twist double ceiling fixing plate, silver, white, each.	
6137 Ceiling fixing plate (single), silver, white.	
6138 Ceiling fixing plate (double), silver, white.	
6143 Rotating glider, 20, 100.	
6146 Nylon hook only, 12, 100.	
6147 Nylon glider hook, 20. Box 500 (on strips). Outer 9,500.	
6160 Track insert for 6100, each.	
6190 Hanger rod assembly complete in silver and white, 61cm (2') or 91cm (3') or to order.	
6191 Hanger tube, silver and white, per metre.	
6192 Ceiling support complete with stud	
6193, silver and white, 100mm.	
6194 Track insert.	
6197 Hanger joint sleeve.	
6283 Roller glider, 10, 100.	
6501 'V' Hanger assembly system, silver, white.	
6503 Wall brackets complete, silver, white. 25mm long with 50mm projection. 50mm long with 50mm projection. 100mm long with 50mm projection. 200mm long with 50mm projection. 50mm long with 100mm projection. 100mm long with 100mm projection. 75mm long with 150mm projection.	
6512 Connecting bridge, silver, white.	
6514 T-junction, single, silver, white.	
6524 Diagonal fixing support, silver, white.	
6525 Double 'T' junction, each, silver, white.	
6610 (old code 6609) Wall support, grey.	
6611 End cover with screw, grey, white, each.	
6625A Complete fixing sleeve, silver, white.	
6199 Internal connecting bridge.	
6187 Dummy ceiling support sleeve, silver, white.	
6175 Mini hanger, silver, white.	
0554 Loading device access.	
0553 Connecting bridge for loading device.	
0552 Transfer unit for loading device.	
11295 Endstop, silver, white, ea, 10.	

	Price Ctg.
<b>Accessories</b>	<b>A</b>
6675 Safety device.	
6655 Wall support.	
6677 V-hanger safety device.	
6663 Wall bracket connector plate.	
6666 Safety connecting bridge.	
6669 Dustcap for 6650.	
6671 Washer insert for wall support.	
6672 Cover for washer insert.	
6679 Acrylic disc for wall support.	

	Price Ctg.
6103 Rail, silver and white, available in 6m lengths.	<b>A</b>
6065 Twist eye endstop, each, 10.	
6094 Roller glider with hook, 10, 100.	
6096 Strip glider. Outer 1,000.	
6098 Roller glider with eye, 10, 100.	
6110 Dustcover, metre, white.	
6124 Twist double ceiling fixing plate, silver, white, each.	
6143 Rotating glider, 20, 100.	
6146 Nylon hook only, 12, 100.	
6147 Nylon glider hook, 20. Box 500 (on strips). Outer, 9,500.	
6193, 50mm, white and silver.	
6190 Hanger rod assembly complete in silver and white. 61cm (2') 91cm (3') or to order.	
6191 Hanger tube, silver and white, per metre.	
6192 Ceiling support complete with stud	
6193, 100m each, silver, white.	
6194 Track insert.	
6197 Hanger joint sleeve, silver, white.	
6283 Roller glider, 10, 100.	
6501 'V' Hanger assembly system, silver, white.	
6503 Wall brackets complete, silver, white. 25mm long with 50mm projection. 50mm long with 50mm projection. 100mm long with 50mm projection. 200mm long with 50mm projection. 50mm long with 100mm projection. 100mm long with 100mm projection. 75mm long with 150mm projection.	
6514M T-junction, single, silver, white.	
6525 Double 'T' junction, silver, white.	
6527 Wall support, metal, white.	
6620 Wall support complete, each, 10. Grey, each, 10. White.	
6625A Complete fixing sleeve, silver, white.	
6630 End cover, grey, white.	
6631 90° connector piece, grey, white.	
6635 Internal connecting bridge.	
6521 External connecting bridge, silver, white.	
6524 Diagonal fixing support, silver, white.	
6175 Mini hanger.	
11295 Endstop, silver, white, each, 10.	

	Price Ctg.
<b>Colours</b> (all colours except white and silver special order – see page 74).	<b>E</b>
<b>Bending</b>	<b>Max. trade discount</b>
Angle bend £63.50. Standard radius 30cm.	33 1/3%
Semi-circe or gradual curve £84.50 each.	

All prices shown exclude VAT

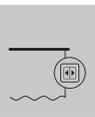

# Electrically Operated Curtain Tracks

## SG 5100

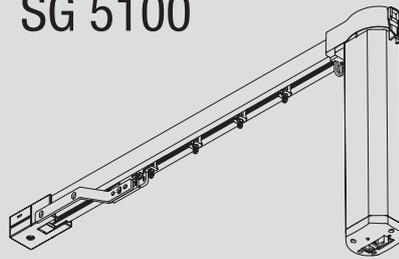

SG 5100 Base  
 SG 5100R with Remote Control  
 SG 5100T with Timer  
 SG 5100TC with Total Control



30cm std.

		Price Ctgy.			Price Ctgy.
<b>System Prices</b> Ready complete and assembled in white only.			<b>SG 5100 (all models)</b> For systems assembled with wave gliders please add the following supplement to standard system price.		<b>A</b>
<b>SG 5100</b>		<b>A</b>	<b>Length</b>		
<b>Base</b>			<b>cm</b>	<b>60mm</b>	<b>80mm</b>
<b>Length</b>			100	39.60	33.89
<b>cm</b>	<b>£</b>		150	59.41	50.84
100	551.33		200	79.22	67.78
150	574.56		250	99.02	84.74
200	597.87		300	118.82	101.69
250	621.09		350	138.64	118.64
300	644.32		400	158.45	135.59
350	667.54		450	178.25	152.55
400	690.77		500	198.06	169.50
450	713.96		550	217.87	186.45
500	737.20		600	237.68	203.40
550	760.43		<b>Standard Accessories</b>		
600	783.66		<b>A</b>		
<b>SG 5100R</b> with Remote Control		<b>A</b>	18R Screw 25mm 0286 Cable Clips 1148C Countersunk screw No.8 31mm 5190 Motor 100-250v AC with 5m lead 10815 Cover White 10823 Belt Connector Arm 10824 Belt Connector Pin 10825 Drive Belt 10836 Hook White 10867 M4 x 16 screw 10925 Profile 10926 Clamp 10931 Roller Glider 10933 Belt Return & Motor Holder Set White 10936 Overlap Arm Set 10940 Belt Return 10945 Endstop 10949 1 Channel Wall Transmitter White 11116 Smart Fix Bracket Cover. 11120 Smart Fix 100mm Bracket (11202 Set).		
<b>Length</b>			<b>Optional Accessories</b>		
<b>cm</b>	<b>£</b>		<b>A</b>		
100	623.02		<b>(Additional charges may apply)</b>		
150	646.23		5192 24v DC moto		
200	669.45		5193 Motor 100-240v AC with mains control		
250	692.68		6349 Wave Curtain Tape FR		
300	715.90		6363 Webbing Tape 70mm. For Wave Curtain 100m		
350	739.12		10905 Glider Cord 80mm for 6.5mm Channel		
400	762.34		10906 Glider Cord 60mm for 6.5mm Channel		
450	785.65		10943 Connecting Bridge		
500	808.89		10946 1 Channel Transmitter White		
550	832.11		10947 2 + 1 Channel Transmitter		
600	855.36		10948 6 + 1 Channel Transmitter		
<b>SG 5100T</b> with Timer		<b>A</b>	10950 2 + 1 Channel Wall Transmitter		
<b>Length</b>			10951 5 + 1 Channel Wall Transmitter		
<b>cm</b>	<b>£</b>		11429 Timer White		
100	724.75		<b>Smart Fix Brackets in white or silver</b>		
150	747.98		11118 Smart Fix 60mm Bracket (11200 Set).		
200	771.20		11119 Smart Fix 80mm Bracket (11201 Set).		
250	794.43		11120 Smart Fix 100mm Bracket (11202 Set).		
300	817.65		11121 Smart Fix 120mm Bracket (11203 Set).		
350	840.86		11122 Smart Fix 150mm Bracket (11204 Set).		
400	864.08		11123 Smart Fix 200mm Bracket (11205 Set).		
450	887.32		<b>Square Smart Fix Brackets in white or silver</b>		
500	910.53		11139 Smart Fix 60mm Bracket (11210 Set).		
550	933.74		11140 Smart Fix 80mm Bracket (11211 Set).		
600	956.95		11141 Smart Fix 100mm Bracket (11212 Set).		
<b>SG 5100TC</b> Total Control option		<b>A</b>	11142 Smart Fix 120mm Bracket (11213 Set).		
<b>Length</b>			11143 Smart Fix 150mm Bracket (11214 Set).		
<b>cm</b>	<b>£</b>		11144 Smart Fix 200mm Bracket (11215 Set).		
100	796.46		11137 Square Smart Fix Bracket Cover.		
150	819.66		<b>Universal Smart Fix Extension Bracket in white or silver</b>		
200	842.89		11154 Universal Smart Fix 120mm.		
250	866.10		11155 Universal Smart Fix 150mm.		
300	889.33		11156 Universal Smart Fix 200mm.		
350	912.54		0722 2mm Allen Key		
400	935.77		<b>E</b>		
450	958.98		<b>Bending</b>		
500	982.21		<b>Max. trade discount</b>		
550	1005.43		33 1/3%		
600	1028.65		Max 2 no. 90° bends or one curve: £177.00. Angle bends standard radius 30cm.		
<b>All prices shown exclude VAT</b>			<b>Note:</b> Autoglide is made-to-measure and cannot be cut down.		

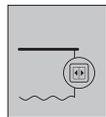

# Electrically Operated Curtain Tracks

## SG 5600

Electrically Operated  
Profile only 10850

Supplied in white, black and anodised silver. Coordinating endpiece set and motor (white/grey).

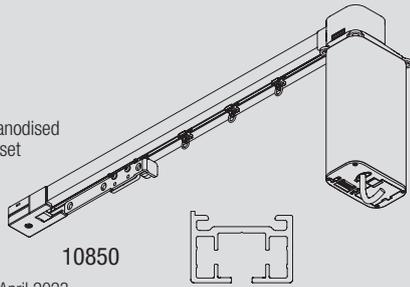

10850



25cm std.

SG 5600 Black available from 1<sup>st</sup> April 2023

System Prices				Price Ctgy.
<b>SG 5600 (9060 motor)</b>				<b>C</b>
Ready complete and assembled*				
60mm wave is only applicable for pair stack. *12m-25m: These limits do not allow auto programming mode, touch and go or manual override				
SG 5600 with std roller glider/std Wave® glider (60*/80mm)				

Shaded sizes are only applicable to standard roller glider (not standard Wave®)

Length	W/S		W/S	
	M	£	M	£
1.5	1503.38		13.5	2305.98
2.0	1536.40		14.0	2339.03
2.5	1569.37		14.5	2372.05
3.0	1602.33		15.0	2405.09
3.5	1635.35		15.5	2438.14
4.0	1668.33		16.0	2471.17
4.5	1701.29		16.5	2504.20
5.0	1734.32		17.0	2537.23
5.5	1767.29		17.5	2570.26
6.0	1800.26		18.0	2603.32
6.5	1843.89		18.5	2636.33
7.0	1878.85		19.0	2669.37
7.5	1909.82		19.5	2702.41
8.0	1942.84		20.0	2735.45
8.5	1975.81		20.5	2768.48
9.0	2008.79		21.0	2801.51
9.5	2041.79		21.5	2834.55
10.0	2074.75		22.0	2867.59
10.5	2107.78		22.5	2900.62
11.0	2140.81		23.0	2933.65
11.5	2173.85		23.5	2966.69
12.0	2206.89		24.0	2999.72
12.5	2239.92		24.5	3032.76
13.0	2272.96		25.0	3065.81

SG 5600 with roller Wave® glider (60*/80mm)				Price Ctgy.	
Length	W/S		W/S		<b>C</b>
	M	£	M	£	
1.5	1563.53		13.5	2847.40	
2.0	1616.61		14.0	2900.48	
2.5	1669.63		14.5	2953.57	
3.0	1722.66		15.0	3006.66	
3.5	1775.72		15.5	3059.74	
4.0	1828.74		16.0	3112.83	
4.5	1881.77		16.5	3165.92	
5.0	1934.83		17.0	3219.01	
5.5	1987.85		17.5	3272.09	
6.0	2040.89		18.0	3325.18	
6.5	2104.56		18.5	3378.27	
7.0	2157.59		19.0	3431.35	
7.5	2210.61		19.5	3484.44	
8.0	2263.66		20.0	3537.53	
8.5	2316.70		20.5	3590.61	
9.0	2369.72		21.0	3643.70	
9.5	2422.77		21.5	3696.79	
10.0	2475.79		22.0	3749.88	
10.5	2528.87		22.5	3802.96	
11.0	2581.96		23.0	3856.05	
11.5	2635.05		23.5	3909.14	
12.0	2688.14		24.0	3962.22	
12.5	2741.22		24.5	4015.31	
13.0	2794.31		25.0	4068.40	

SMART by Silent Gliss - For SG 5600 control via third party control systems, please add the below per system:		Price Ctgy.
11270 Plug in RS 485 motor module, white		<b>C</b>
Add £233.45 per system		
**Power supplies not included - see separate associated components prices, page 28.		

All prices shown  
exclude VAT

SG 5600 with radio module, std roller glider/std wave glider (60*/80mm)				Price Ctgy.	
Length	W/S		W/S		<b>C</b>
	M	£	M	£	
1.5	1712.59		13.5	2515.15	
2.0	1745.54		14.0	2548.19	
2.5	1778.49		14.5	2581.21	
3.0	1811.49		15.0	2614.25	
3.5	1844.50		15.5	2647.29	
4.0	1877.47		16.0	2680.32	
4.5	1910.46		16.5	2713.37	
5.0	1943.43		17.0	2746.39	
5.5	1976.43		17.5	2779.43	
6.0	2009.39		18.0	2812.46	
6.5	2053.03		18.5	2845.51	
7.0	2086.00		19.0	2878.52	
7.5	2118.99		19.5	2911.57	
8.0	2151.98		20.0	2944.60	
8.5	2184.95		20.5	2977.64	
9.0	2217.92		21.0	3010.68	
9.5	2250.91		21.5	3043.70	
10.0	2283.90		22.0	3076.74	
10.5	2316.94		22.5	3109.78	
11.0	2349.96		23.0	3142.81	
11.5	2383.02		23.5	3175.85	
12.0	2416.03		24.0	3208.87	
12.5	2449.07		24.5	3241.92	
13.0	2482.11		25.0	3274.95	

SG 5600 with radio module and roller wave glider (60*/80mm)				Price Ctgy.	
Length	W/S		W/S		<b>C</b>
	M	£	M	£	
1.5	1772.73		13.5	3056.55	
2.0	1825.75		14.0	3109.64	
2.5	1878.75		14.5	3162.72	
3.0	1931.80		15.0	3215.81	
3.5	1984.86		15.5	3268.90	
4.0	2037.89		16.0	3321.98	
4.5	2090.92		16.5	3375.07	
5.0	2143.96		17.0	3428.16	
5.5	2196.99		17.5	3481.25	
6.0	2250.02		18.0	3534.33	
6.5	2313.71		18.5	3587.42	
7.0	2366.73		19.0	3640.51	
7.5	2419.78		19.5	3693.59	
8.0	2472.80		20.0	3746.68	
8.5	2525.84		20.5	3799.77	
9.0	2578.86		21.0	3852.86	
9.5	2631.89		21.5	3905.94	
10.0	2684.94		22.0	3959.03	
10.5	2738.03		22.5	4012.12	
11.0	2791.11		23.0	4065.20	
11.5	2844.20		23.5	4118.29	
12.0	2897.29		24.0	4171.38	
12.5	2950.38		24.5	4224.46	
13.0	3003.46		25.0	4277.55	

**5600 Black**  
The 5600 will be available in Black as standard from 1st April 2023.  
Please add a 10% uplift to the White pricing tables.  
**Note:** if a 5600 is ordered in black with one of the following glider types:

- 10840 2C Roller Glider
- 10869 Wave Roller Glider Cord 60mm
- 10852 Wave Roller Glider Cord 80mm

The gliders will be supplied in black as standard.

Standard Accessories		Price Ctgy.
3004	Clamp	<b>C</b>
9060	Motor, white, grey, black	
9916	In-line connector	
10816	Motor cover, white, grey, black	
10817	Motor case holder, white, grey, black	
10819	Belt return, white, grey, black	
10820	Overlap arm, straight, white, black	
10821	Overlap arm, bent, white, black	
10822	Master carrier set, white, black	
10826	Overlap arm support set	
10837	Pilot runner arm, white, black	
10838	Pilot runner set, white, black	
10840	2C Roller glider, white, black	
10850	Profile, white, silver, black per metre	

Standard Accessories		Price Ctgy.
10815	Cover, white, grey, black	<b>A</b>
10825	Belt	
10836	Mask pair stack, white, grey, black	

Optional Accessories		Price Ctgy.
<small>(Additional charges may apply)</small>		
3041	Bracket	<b>C</b>
5118	Wedge for recess profile, white, black	
6794	Screw for direct fix	
9063	Radio module set for 9940 Radio system, grey, white, black	
9960	Move Server Set (includes 1 x transmitter stick)	
9961	Move Transmitter Stick	
10862	Recess profile, white, black per metre	
10863	Recess mask, motor, white, black	
10864	Recess mask, belt return, white, black	
10865	Mounting support plate	
10821L	Long overlap arm bent	
10822	Master carrier set, white	
10831	Connecting bridge	
10838	Pilot runner set, white	
10844	Wave end stop, motor, grey, white, black	
10845	Wave master carrier, white, black single stack 80mm	
10852	Wave roller glider cord, black, white (80mm pitch), 6.5mm channel	
10856	Wave end stop, belt return, white, grey, black	
10869	Wave roller glider cord, white, black (60mm pitch), 6.5mm channel	
10886	Wave overlap arm, pilot runner set, white, black	
10887	Wave overlap arm set, white, black	
10926	Wave glider support	
11411	Radio module set for 0450 Radio system, grey, white	
11412	Power supply 24V DC UL	

Optional Accessories		Price Ctgy.
<small>(Additional charges may apply)</small>		
3832	Twist clamp	<b>A</b>
3582	Curtain hook, white, black box, 100. Self-service sachets, 25 x 25. Outer, 20,000	
6094	Roller glider with hook, 10, 100	
6349	Wave @ curtain tape, white, black	
6363	Top hemming tape	
7002	Profile protector	
10075	Lead weight 50 gr/m	
10076	Fabric weight	
10823	Belt connector arm	
10824	Belt connector pin	
10854	Wave overlap support arm, white, black	
10905	Wave glider cord, white (80mm pitch), 6.5mm channel	
10906	Wave glider cord, white (60mm pitch), 6.5mm channel	
10924	Wave glider support, white, black	
11116	Smart Fix Bracket Cover.	
11137	Square Smart Fix Bracket Cover.	
<b>Smart Fix Brackets in white, black or silver</b>		
11118	Smart Fix 60mm Bracket (11200 Set).	
11119	Smart Fix 80mm Bracket (11201 Set).	
11120	Smart Fix 100mm Bracket (11202 Set).	
11121	Smart Fix 120mm Bracket (11203 Set).	
11122	Smart Fix 150mm Bracket (11204 Set).	
11123	Smart Fix 200mm Bracket (11205 Set).	
<b>Square Smart Fix Brackets in white, black or silver</b>		
11139	Smart Fix 60mm Bracket (11210 Set).	
11140	Smart Fix 80mm Bracket (11211 Set).	
11141	Smart Fix 100mm Bracket (11212 Set).	
11142	Smart Fix 120mm Bracket (11213 Set).	
11143	Smart Fix 150mm Bracket (11214 Set).	
11144	Smart Fix 200mm Bracket (11215 Set).	
<b>Universal Smart Fix Extension Bracket in white, black or silver</b>		
11154	Universal Smart Fix 120mm.	
11155	Universal Smart Fix 150mm.	
11156	Universal Smart Fix 200mm.	

Recess Profile and Accessories White or Black		Price Ctgy.
Charged at the nearest 25cm increment above.		
White	Per Metre	Per Length
	£48.17	£9.78

Colours		Price Ctgy.
Other colours special order, see page 74.		

Tools		Price Ctgy.
7426	Notching tool for recess 10862	<b>E</b>

Bends	Max. trade discount	25%
For each bend add the following to above system price:		
Radius/cm	Profile 10850	
25-99	£167.00	
Standard angle bend radius 25cm.		
Over 99	£313.00	
<small><b>Note:</b> If using recess profile, price add an additional 20% to the relevant bending charge above. Please note: Minimum radius for 5600 is 25cm. Minimum radius for 5600 with recess profile is 50cm.</small>		

Multiple System Operation		Price Ctgy.
A wide range of multiple operation methods are available, including low voltage control, radio/remote control and mixed systems. Can also be controlled through a smartphone, tablet or desktop with the Silent Gliss app 'Move' (refer to page 28 for pricing details). Please consult the Silent Gliss catalogue.		

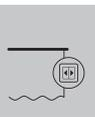

# Electrically Operated Curtain Tracks

## SG 5800

Electrically Operated

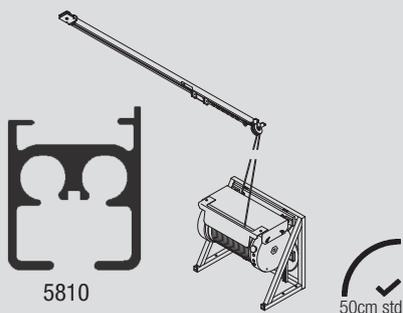

			Price Ctgy.
<b>System Prices</b>			<b>C</b>
Ready complete and assembled (as far as possible depending on transport requirements).			
Length	Price Single Track £	Price 2 Parallel Tracks £	
M			
12	20575.91	28313.89	
13	21001.25	29164.53	
14	21392.32	29946.66	
15	21783.38	30728.79	
16	22174.45	31510.95	
17	22565.52	32293.08	
18	22956.62	33075.25	
19	23381.91	33925.88	
20	23772.99	34708.05	
21	24164.07	35490.17	
22	24555.13	36272.30	
23	24946.21	37054.45	
24	25337.28	37836.59	
25	25762.59	38687.27	
26	26153.67	39469.41	
27	26544.74	40251.54	
<p>SG 5800 can cover windows up to 60m if pair stacked. On lengths of this size Silent Gliss advice should be sought but as a guide price for each metre above 27m the following should be added:</p> <p>Single width £366.18 Two tracks in parallel £732.36</p> <p>Track lengths between those specified will be charged at the rate for the nearest metre above. Price includes 6209 Top fix clamps, 5821/22 Wall mounting for motor, 5811 Overlap, 5809 Roller gliders at 5 per metre and where length exceeds 6 metres 6203 Connecting bridge. 0615 plastic switch with recess box. Earth is required.</p>			
<b>Standard Accessories</b>			<b>C</b>
<p>5806 Pilot Runner. 5809 Roller glider, 10. 5810 Silver profile only. 5824 Endstop. 5811 Overlap. 5814 Cable, metre. 5815 Cord guide return. 5816 Cord guide. 5834 Cable connector. 6203 Connecting bridge. 6209 Clamp, each, 10.</p>			
<b>Optional Accessories</b>			<b>C</b>
(Additional charges may apply)			
0578 Recess pattress, metal.			
0615 Latching switch			
6228 Double fixing plate.			
5829 2 Hole fixing plate.			
5813 Floor mounting frame.			
<b>Colours</b>			<b>E</b>
Special quotation.			
<b>Bending</b>			<b>25%</b>
Radius	Each		
cm	£		
32-99	347.50		
99-349	515.00		
Over 350	672.50		
Standard angle bend radius 50cm			
<b>Remote/Multiple System Operation</b>			<b>C</b>
Must not be wired in parallel. For information consult Silent Gliss.			

All prices shown exclude VAT



# Switches, Remote Control & Multiple Operation of Motorised Systems

## SG Control R SG 0450

Radio controlled systems

## SG Control L SG 9940

Radio controlled systems

## SG SMART by Silent Gliss

For control via third party control systems

## SG Control A Battery Operated Blinds

Remote and Wall Plates

All costs for systems indicated in this section are exclusive of curtain/blind systems and need to be added for total cost. On-site wiring costs are also excluded although advisory service is available. To assist choosing the correct equipment please see application chart in the back of the price list. 10949 come as standard with Battery Operated systems. This can not be exchanged/returned for another control.

	Price Ctg.
<b>SG 0450</b>	<b>C</b>
Radio control system, up to 255 room and blind addresses, individually or simultaneously. Use with mains electric systems (motor types A & B). Low voltage option (motor type C) available on request.	
20918	£352.53
Control Module (motor type A)	
20919	£352.53
Control Module (motor type B)	
20907	£380.58
Control Module (low voltage motor type C)	
20913	£291.90
Single-channel wall switch. Available in the following colours:	
Antique Brass	
Black Nickel	
Chocolate Bronze	
Matt Black	
Matt White	
Polished Brass	
Mirror Polish	
Brushed Silver	
20914	£291.90
Eight-channel wall switch. Available in the following colours:	
Antique Brass	
Black Nickel	
Chocolate Bronze	
Matt Black	
Matt White	
Polished Brass	
Mirror Polish	
Brushed Silver	
20336	£215.49
Eight channel hand held remote	
<b>Optional Accessories</b>	<b>C</b>
20917	£24.65
White pattress box	

	Price Ctg.
<b>SG 9940</b>	<b>C</b>
9068	£469.65
Single-channel receiver	
9944	£360.12
Single-channel receiver, non latching	
9945	£325.61
Single-channel receiver, latching	
9947	£212.79
Control Unit DC 24V	
10300	£264.74
Single-channel hand-held remote	
10302	£264.74
5+1 channel hand-held remote	
10303	£322.67
10+2+1 channel hand-held remote. Inc. timer	
10804	£322.66
15+5+1 channel hand-held remote	
Hand-held remotes are available in White, Silver or Anthracite	
11412	£71.58
Power supply 24V DC	
11480	£135.92
1 channel wall switch	
11490	£249.31
5 channel wall switch	
Uplift for integrated 9940 receiver in Series 40 motors – Add on £233.45 per system for 4960/4970/2350/4760/4770/4780 Add on £299.29 per system for 4880	<b>C</b>
Uplift for integrated 9940 receiver for systems 2950 or 8960 Add on £284.71 per system for 2950 Add on £212.74 per system for 8960	<b>E</b>
Engraving of above remotes is available at £51.66 per remote. Delivery: 4 weeks.	<b>C</b>
<b>Move Server Set</b>	
9960	£1188.68
Set (consists of server and transmitter stick)	
9961	£434.87
Transmitter stick	

	Price Ctg.
0323	£2.21
0.5m Blue Patch Cable	
11260	£885.90
Gateway	
11261	£1065.47
Gateway KNX	
11262	£861.95
Expansion Unit	
11263	£82.47
Power supply 24V DC 2 Ampere	
DIN Rail	
11264	£100.70
Power supply 24V DC 3.8 Ampere	
DIN Rail	
11265	£106.58
Power supply 24V DC 5 Ampere	
DIN Rail	
11266	£196.58
Power supply 24V DC 10 Ampere	
DIN Rail	
11270	£233.45
RS 485 module set white	
11281	£2673.00
Cabinet up to 8 Shading Device Unit including Circuit Breaker Protection	
11282	£3447.00
Cabinet up to 24 Shading Device Unit including Circuit Breaker Protection	
11283	£6534.00
Cabinet up to 56 Shading Device Unit including Circuit Breaker Protection	
11318	£11.13
4-Pin Connector for 5600 SMART module	
11319	£11.13
4-Pin Connector for SMART motor (Motor Side)	
11320	£16.70
4-Pin Connector for SMART motor (Room Side)	
11325	£14.72
6-Pin Connector for Gateway and Expansion Unit	
11269	£119.72
Hand held setting tool for Series 40 and SMART motors (TTPRO)	<b>E</b>
<b>Labour</b>	
To fully assemble cabinet with SMART Gateway, expansion unit (if required) and	
Power Supplies:	
Up to 8 systems (Labour cost only)	£98.21
Up to 24 systems (Labour cost only)	£264.42
Up to 56 systems (Labour cost only)	£679.94
SMART by Silent Gliss motors for use with Silent Gliss Gateway and associated components – Add on £233.45 per system for 4960/4970/2350/4760/4770/4780/5600 Add on £299.29 per system for 4880	<b>C</b>

	Price Ctg.
<b>Battery Controls</b>	<b>A</b>
10949	£50.31
1 Channel Wall Transmitter, White	
10950	£74.43
2 + 1 Channel Wall Transmitter, White	
10951	£74.43
5 + 1 Channel Wall Transmitter, White	
10946	£60.66
1 Channel Remote	
10947	£74.43
2 + 1 Channel Remote	
10948	£74.43
6 + 1 Channel Remote	
11429	£146.82
Single Channel Timer	
<b>Fixed switches for mains control</b>	<b>C</b>
Switches are available single or in banks as below. Add switches price to price of system. Switches are designed for recess fixing.	
<b>Non-latching</b>	
<b>1 Gang Switches</b>	
0565/W White plastic	£122.33
<b>2 Gang Switches</b>	
0566/W White plastic	£211.76
<b>3 Gang Switches</b>	
0567/W White plastic	£329.76
<b>4 Gang Switches</b>	
0568/W White plastic	£419.21
<b>6 Gang Switches</b>	
0569/W White plastic	£632.88
<b>Latching</b>	
<b>1 Gang Switches</b>	
0615/W White plastic	£66.07
<b>2 Gang Switches</b>	
0616 White plastic	£89.04
<b>3 Gang Switches</b>	
0617 White plastic	£144.70
<b>4 Gang Switches</b>	
0618 White plastic	£174.01
<b>6 Gang Switches</b>	
0619 White plastic	£241.15
<b>Extras</b>	
9959 Relay	£178.07
9953 Volt free interface	£231.02
<b>Tools</b>	<b>E</b>
11269 Handheld setting tool for Series 40 and SMART Motors TTPRO	£119.72

All prices shown exclude VAT



# Roman Blind Systems

## SG 2120

Chain operated headrail system for Roman Blinds. For medium to heavy weight applications.

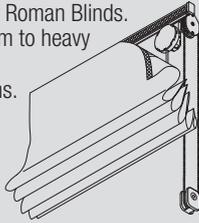

## SG 2305

Chain operated headrail system for Roman Blinds with integral child safety breakaway mechanism. For medium to heavy weight applications.

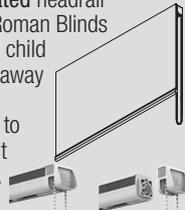

SG 2305 Black available from 1<sup>st</sup> April 2023

	Price Ctg.																												
<b>SG 2120 System supplied ready assembled</b> Total max. curtain weight 8kg incl. any weighting. Maximum width: 4.0m Maximum drop: 6.0m <b>System width</b> <table border="1"> <thead> <tr> <th>cms</th> <th>£</th> </tr> </thead> <tbody> <tr><td>100</td><td>204.56</td></tr> <tr><td>125</td><td>235.49</td></tr> <tr><td>150</td><td>275.13</td></tr> <tr><td>175</td><td>315.68</td></tr> <tr><td>200</td><td>346.61</td></tr> <tr><td>225</td><td>386.45</td></tr> <tr><td>250</td><td>426.35</td></tr> <tr><td>275</td><td>457.31</td></tr> <tr><td>300</td><td>497.21</td></tr> <tr><td>325</td><td>537.12</td></tr> <tr><td>350</td><td>582.69</td></tr> <tr><td>375</td><td>616.99</td></tr> <tr><td>400</td><td>656.90</td></tr> </tbody> </table> Above prices are based on standard accessories detailed below.	cms	£	100	204.56	125	235.49	150	275.13	175	315.68	200	346.61	225	386.45	250	426.35	275	457.31	300	497.21	325	537.12	350	582.69	375	616.99	400	656.90	A
cms	£																												
100	204.56																												
125	235.49																												
150	275.13																												
175	315.68																												
200	346.61																												
225	386.45																												
250	426.35																												
275	457.31																												
300	497.21																												
325	537.12																												
350	582.69																												
375	616.99																												
400	656.90																												
<b>Standard Accessories</b> 2049 Gear drive, each, 10, 100. 2081 Take-up reel, each, 10. 2059 Safety clip, 10. 2111 Hexagonal bar, 6m length, outer of 50 lengths. 2163 Flat drawing tape, per m, 200m 2211 Touch and close headrail, 6m, length. 2179 End cover, each, 10. 3630 Universal bracket, each, 10, 100. 4845 Metal bead chain, 125m reel. 2865 Twin chain connector, each.	A																												
10731 Cord retainer.	E																												
<b>Optional Accessories</b> (Additional Charges May Apply) 0549 Touch and close pencil pleat tape for Austrian Blinds. 2091 Endcover (for 2135) 3164 Breakaway hook and latch set. 3165 Breakaway ring set (soft fold). 3166 Breakaway ring tape (soft fold). 2006 Bottom weight bar, 4m. 2072A Universal joint, each. 2135 Steel rod, 3m lengths. 2164/2164T Ring tape, 50m. 2539 Touch and close pile section, 25m, 100m. 3069 Breakaway rod cover (hard fold). 11116 Smart Fix Bracket Cover. 11137 Square Smart Fix Bracket Cover. <b>Smart Fix Brackets in white or silver</b> 11118 Smart Fix 60mm Bracket (11200 Set). 11119 Smart Fix 80mm Bracket (11201 Set). 11120 Smart Fix 100mm Bracket (11202 Set). 11121 Smart Fix 120mm Bracket (11203 Set). 11122 Smart Fix 150mm Bracket (11204 Set). 11123 Smart Fix 200mm Bracket (11205 Set). <b>Square Smart Fix Brackets in white or silver</b> 11139 Smart Fix 60mm Bracket (11210 Set). 11140 Smart Fix 80mm Bracket (11211 Set). 11141 Smart Fix 100mm Bracket (11212 Set). 11142 Smart Fix 120mm Bracket (11213 Set). 11143 Smart Fix 150mm Bracket (11214 Set). 11144 Smart Fix 200mm Bracket (11215 Set). 3603 Top fix brackets, each, 10, 100. 3655 Long universal bracket. 3660 Extra long universal bracket. 4845BR Metal bead chain, brass.	A																												
<b>Tools</b> 0679 Connector tongs.	E																												

	Price Ctg.																																	
<b>SG 2305 System</b> Supplied made to measure, ready assembled. Maximum width: 3.0m Maximum drop: 3.4m <table border="1"> <thead> <tr> <th>System width cms</th> <th>White £</th> <th>Black £</th> </tr> </thead> <tbody> <tr><td>75</td><td>63.78</td><td>76.54</td></tr> <tr><td>100</td><td>77.60</td><td>93.12</td></tr> <tr><td>125</td><td>83.76</td><td>100.51</td></tr> <tr><td>150</td><td>95.99</td><td>115.19</td></tr> <tr><td>175</td><td>102.15</td><td>122.58</td></tr> <tr><td>200</td><td>114.37</td><td>137.24</td></tr> <tr><td>225</td><td>128.21</td><td>153.85</td></tr> <tr><td>250</td><td>134.36</td><td>161.23</td></tr> <tr><td>275</td><td>146.59</td><td>175.91</td></tr> <tr><td>300</td><td>152.75</td><td>183.30</td></tr> </tbody> </table> Above prices are based on standard accessories detailed below.	System width cms	White £	Black £	75	63.78	76.54	100	77.60	93.12	125	83.76	100.51	150	95.99	115.19	175	102.15	122.58	200	114.37	137.24	225	128.21	153.85	250	134.36	161.23	275	146.59	175.91	300	152.75	183.30	A
System width cms	White £	Black £																																
75	63.78	76.54																																
100	77.60	93.12																																
125	83.76	100.51																																
150	95.99	115.19																																
175	102.15	122.58																																
200	114.37	137.24																																
225	128.21	153.85																																
250	134.36	161.23																																
275	146.59	175.91																																
300	152.75	183.30																																
<b>Please note:</b> Instead of standard silver metal chain (on white systems) corresponding white plastic chain can be supplied at no extra cost (subject to availability). This system can also be supplied without the child safety breakaway mechanism at the same cost if required.	A																																	
<b>Standard Accessories</b> 2301 Aluminium headrail white, black (5.8m). 2309 Hex bar (5m). 2308 Spool with lift cord, white, black. 2307 Gear/Breakaway set (4:1), white, black. 2302 Clip bracket, white, black. 2311 Metal chain, silver, black (150m reel).	A																																	
<b>Optional Accessories</b> (Additional Charges May Apply) 2091 Endcover (for 2135) 2310 Plastic operating chain (250m reel), white. 2311AB Metal chain, antique brass (150m reel) 2311BL Metal chain, pewter (150m reel) 2311GD Metal chain, gold (150m reel) 2312 Bead chain joiner. 2317 Gear without breakaway mechanism (4:1), white, black. 2346 Clamp bracket. 2347/50 50cm finished plastic chain drop, white. 2347/75 75cm finished plastic chain drop, white. 2347/100 100cm finished plastic chain drop, white. 2347/125 125cm finished plastic chain drop, white. 2347/150 150cm finished plastic chain drop, white. 2347/175 175cm finished plastic chain drop, white. 2347/200 200cm finished plastic chain drop, white. 3164 Breakaway hook and latch set. 3165 Breakaway ring set (soft fold). 3166 Breakaway ring tape (soft fold). 2005 Bottom bar. 2006 Bottom bar. 2135 Steel rod, 3m lengths. 2164/2164T Ring tape, 50m. 2539 Touch and close pile section, 25m, 100m. 3069 Breakaway rod cover (hard fold). 11116 Smart Fix Bracket Cover. 11137 Square Smart Fix Bracket Cover. <b>Smart Fix Brackets in white, black or silver</b> 11118 Smart Fix 60mm Bracket (11200 Set). 11119 Smart Fix 80mm Bracket (11201 Set). 11120 Smart Fix 100mm Bracket (11202 Set). 11121 Smart Fix 120mm Bracket (11203 Set). 11122 Smart Fix 150mm Bracket (11204 Set). 11123 Smart Fix 200mm Bracket (11205 Set). <b>Square Smart Fix Brackets in white, black or silver</b> 11139 Smart Fix 60mm Bracket (11210 Set). 11140 Smart Fix 80mm Bracket (11211 Set). 11141 Smart Fix 100mm Bracket (11212 Set). 11142 Smart Fix 120mm Bracket (11213 Set). 11143 Smart Fix 150mm Bracket (11214 Set). 11144 Smart Fix 200mm Bracket (11215 Set).	A																																	
0600 Connector tongs for metal chain. 7223 Tongs for connector 2865 10731 Cord retainer	E																																	

All prices shown exclude VAT



# Roman Blind Systems

## SG 2345

Battery Operated

Battery operated radio controlled for Roman Blinds

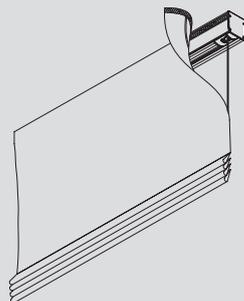

## SG 2350

Electrically Operated

For medium/heavy Roman Blinds.

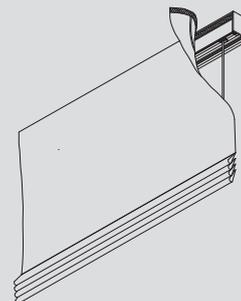

	Price Ctg.
<b>Battery operated SG 2345 supplied ready assembled</b>	<b>C</b>
Total maximum curtain weight 2.5kg. Maximum width 6 metres. Maximum drop 6 metres, maximum total surface area 36m <sup>2</sup> depending on curtain weight. Minimum width 60cm. Hardware only cost.	
<b>SYSTEM WIDTHS (cms)</b>	<b>£</b>
100	540.06
125	565.06
150	596.01
175	620.93
200	650.45
225	684.01
250	706.38
275	739.86
300	762.24
325	787.18
350	818.08
375	843.04
400	872.63
425	906.10
450	928.49
475	961.95
500	984.34
525	1009.34
550	1040.26
575	1065.20
600	1087.56
Above prices are based on Standard Accessories detailed below.	
<b>Standard Accessories</b>	<b>A</b>
1148C No.8 Cross Head Woodscrew	
2216 Cord	
2221 Hook Tape	
2351 Profile White for system 2345	
2352 Profile silver for system 2345	
10949 1 Channel Wall Transmitter White	
2353 Motor cover for system 2345	
2354 Cover for system 2345	<b>C</b>
2357 Pin for system 2345	
2358 Shell for system 2345	
2359 Support for system 2345	
2361 Adaptor for system 2345	
2363 Wall/Ceiling Bracket	
2368 Motor Adaptor Plate for SG2345	
3003 Clamp	
11071 Motor Drive for SG2345	
11074 Tube adaptor for SG2345	
11076 1.2nm Motor for 2345	
11077 Battery Box for Motor 11076	
11085 Battery Box Holder	
11099 Battery for 2345	
All prices shown exclude VAT	

	Price Ctg.
<b>Optional Accessories</b>	<b>A</b>
(Additional Charges May Apply)	
3069 Breakaway Rod Cover	
3164 Breakaway bottom bar set	
3166 Breakaway ring set tape (soft fold)	
2135 Breakaway ring tape (soft fold)	
2136 Steel Rod	
3069 Breakaway rod cover (hard fold)	
2005 Bottom Bar	
2006 Weight bar	
10946 Radio hand-held transmitter 1 channel	
10947 Radio hand-held transmitter 2 + 1 channel	
10948 Radio hand-held transmitter 6 + 1 channel	
10950 Radio wall transmitter 2 channel	
10951 Radio wall transmitter 5 + 1 channel	
11429 Timer White	
<b>Smart Fix Brackets in white, black or silver</b>	
11118 Smart Fix 60mm Bracket (11200 Set).	
11119 Smart Fix 80mm Bracket (11201 Set).	
11120 Smart Fix 100mm Bracket (11202 Set).	
11121 Smart Fix 120mm Bracket (11203 Set).	
11122 Smart Fix 150mm Bracket (11204 Set).	
11123 Smart Fix 200mm Bracket (11205 Set).	
<b>Square Smart Fix Brackets in white, black or silver</b>	
11139 Smart Fix 60mm Bracket (11210 Set).	
11140 Smart Fix 80mm Bracket (11211 Set).	
11141 Smart Fix 100mm Bracket (11212 Set).	
11142 Smart Fix 120mm Bracket (11213 Set).	
11143 Smart Fix 150mm Bracket (11214 Set).	
11144 Smart Fix 200mm Bracket (11215 Set).	
<b>Smart Fix Bracket Covers</b>	
11116 Smart Fix Bracket Cover.	
11137 Square Smart Fix Bracket Cover.	
<b>Universal Smart Fix Extension Bracket in white, black or silver</b>	
11154 Universal Smart Fix 120mm.	
11155 Universal Smart Fix 150mm.	
11156 Universal Smart Fix 200mm.	
2362 Wire Holder	<b>C</b>
2521 Bracket	
8235 Wire Base Short	
8236 Wire Base Long	
8237 Wire Holder	
8249 Locking ring	

	Price Ctg.
<b>Electrically operated 2350 for straight vertically-hung Austrian, Roman and Festoon Blinds</b>	<b>C</b>
Total maximum curtain weight 15kg. Maximum width 6 metres. Maximum drop 6 metres, maximum total surface area 36m <sup>2</sup> depending on curtain weight.	
Hardware cost only.	
<b>SYSTEM WIDTHS (cms)</b>	<b>£</b>
100	908.54
150	952.69
200	996.92
250	1041.14
300	1085.36
350	1129.54
400	1173.78
450	1217.98
500	1262.16
550	1306.39
600	1350.58
<b>Optional Accessories</b>	<b>A</b>
(Additional Charges May Apply)	
3164 Breakaway hook and latch set.	
3165 Breakaway ring set (soft fold).	
3166 Breakaway ring tape (soft fold).	
2005 Bottom bar	
2006 Bottom bar 1m, 5m	
2109Eyelet	
2144 Cross Rail	
2164 Ring Tape	
2539 Touch and close pile section, 25m, 100m	
2616 Bracket (40.8mm)	
3069 Breakaway rod cover (hard fold).	
11116 Smart Fix Bracket Cover.	
11137 Square Smart Fix Bracket Cover.	
<b>Smart Fix Brackets in white, black or silver</b>	
11118 Smart Fix 60mm Bracket (11200 Set).	
11119 Smart Fix 80mm Bracket (11201 Set).	
11120 Smart Fix 100mm Bracket (11202 Set).	
11121 Smart Fix 120mm Bracket (11203 Set).	
11122 Smart Fix 150mm Bracket (11204 Set).	
11123 Smart Fix 200mm Bracket (11205 Set).	
<b>Square Smart Fix Brackets in white, black or silver</b>	
11139 Smart Fix 60mm Bracket (11210 Set).	
11140 Smart Fix 80mm Bracket (11211 Set).	
11141 Smart Fix 100mm Bracket (11212 Set).	
11142 Smart Fix 120mm Bracket (11213 Set).	
11143 Smart Fix 150mm Bracket (11214 Set).	
11144 Smart Fix 200mm Bracket (11215 Set).	
2363 Wall/ceiling bracket	<b>C</b>
2521 Bracket (49.6mm)	

	Price Ctg.
<b>Remote/Multiple System Operation</b>	<b>C</b>
For system operation possibilities refer to table on page 92	
<b>Side-guide option available at an additional cost of £76.49.</b>	<b>C</b>
<b>System Control Options</b>	<b>C</b>
Radio control standard option is with System 0450, see page 28.	
<b>Series 40 motors – With integrated radio receiver for operation with SG wireless system 9940 – add on £233.45 per system, see page 28. NOTE: 24v Series 40 Motors are not supplied with power supplies (transformers) as standard. They must be ordered separately, see page 28.</b>	
<b>SMART by Silent Gliss motors – for use with Silent Gliss Gateway and associated components – add on £233.45 per system, see page 28.</b>	





# Sliding Panels

## SG 2700 (Hand) SG 2710 (Cord) Panel Glide

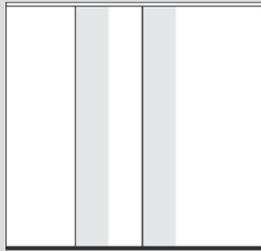

## SG 2730 Panel Flex



SG 2700/SG 2710 is delivered made to measure, ready assembled in white, top fix as standard. Panels either hang freely or can be connected and operated via a draw rod or cord at no extra cost.

SG 2730 is delivered made to measure, ready assembled in white. Panels either hang freely or can be connected and operated via a draw rod.

The systems are built up from different profiles with between 2 and 5 channels. Please consult the Silent Gliss catalogue to ensure you order the correct profile depending on how many panels and which stacking variation you require. Some technical restrictions apply.

Panels are usually between 50cm and 100cm and we recommend they overlap by approximately 10cm-15cm.

SG 2700 can be electrically operated in combination with SG 5600. For pricing, please add cost of 5600 Electric Track onto prices below. Please consult Silent Gliss for further information.

SG 2730 is only available as complete systems with fabric panels.

HARDWARE PRICES		Price Ctg.
SG 2700/SG 2710 – Straight Only		<b>C</b>
	<b>Manual</b>	
150cm	388.68	
200cm	488.34	
250cm	587.99	
300cm	687.65	
350cm	787.34	
400cm	886.98	
450cm	986.64	
500cm	1086.29	
550cm	1184.05	
600cm	1278.77	
PRICES PER FABRIC PANEL (max drop 3m)		
	Up to 60cm wide	60cm - 130cm wide
Price Group 1	£267.69	£344.85
Price Group 2	£306.23	£400.02
Price Group 3	£397.24	£550.65
Price Group 4	£600.76	£797.47
FABRIC SUITABILITY		
Price Group 1		
Basic Screen 1%	Colorama 1 Multicolour	
Basic Screen 5%	Colorama Acoustic	
Basic Screen 10%	Colorama Acoustic Multicolour	
Colorama 1	Element	
Colorama 1 Alu	Oscurante	
Colorama 1 Bioactive	Polyflax	
Colorama 1 Eco	Someo	
	Valere	
Price Group 2		
Atracor	Multi Shadow	Safescreen
Colorama 2	Multi Visio	Triscreen 1%
Colorama 2 Eco	Multiscreen 1%	Triscreen 3%
Colorama 2 Multicolour	Multiscreen 5%	Triscreen 5%
Leviso	Multiscreen 10%	Verascreen 1%
Leviso Light	Newlifescreeen	Verascreen 2%
Mercurio	Nox	Verascreen 5%
Moon	Reflex	Verascreen 10%
Price Group 3		
Alutex	Newlifescreeen Alu	
Colorama 2 Bioactive	Multicolour Dimout	
Colorama Dimout	Twin Blackout	
Price Group 4		
Aluscreen Futura Deep		

Supplied with roller gliders as standard, available with optional click-in gliders at no extra cost.  
Face fix brackets will carry an additional cost.

All prices shown exclude VAT

HARDWARE PRICES		Price Ctg.
SG 2730 – Straight or Curved		<b>C</b>
	<b>Manual</b>	
150cm	423.80	
200cm	551.02	
250cm	678.20	
300cm	805.39	
350cm	932.60	
400cm	1059.78	
450cm	1187.02	
500cm	1314.19	
550cm	1441.38	
600cm	1568.59	
PRICES PER FABRIC PANEL (max drop 3m)		
	Up to 60cm wide	60cm - 130cm wide
Price Group 1	£267.69	£344.85
Price Group 2	£306.23	£400.02
Price Group 3	£397.24	£550.65
Price Group 4	£600.76	£797.47
FABRIC SUITABILITY		
Price Group 1		
Colorama 1	Colorama 2	Price Group 3
Colorama 1 Alu	Colorama 2 Bioactive	Colorama Dimout
Colorama 1 Bioactive	Colorama 2 Eco	
Colorama 1 Eco	Colorama 2 Multicolour	
Colorama 1 Multicolour	Leviso	
Colorama Acoustic	Leviso Light	
Colorama Acoustic Multicolour	Reflex	
Oscurante		
Polyflax		
Someo		
Valere		
BENDS		Max. trade discount 25%
For each bend add the following to the above system price		
Angle bend	£538.50 Standard radius 15cm	
Gradual curve	£864.50	
SG 2730		
10399 Design Fascia	£28.90 per metre, plus £4.30 per system	<b>A</b>
COLOURS		
Special colours not available		

All prices shown exclude VAT



# Skylight Systems

**SG 2190**  
Crank Operated  
For curved, sloping or horizontal Roman Blinds.

20cm std.

Width > Drop (cms)	Up to 100cm	101cm-150cm	151cm-200cm	201cm-250cm
150	1006.47	1067.16	1127.86	1188.56
200	1116.13	1176.85	1237.58	1298.28
250	1225.83	1286.55	1347.28	1408.03
300	1335.58	1396.24	1457.05	1517.73
350	1445.33	1506.02	1566.75	1627.39
400	1555.04	1615.76	1676.42	1737.18
450	1664.77	1725.46	1786.13	1846.85
500	1774.48	1835.14	1895.82	1956.58
550	1884.12	1944.82	2005.63	2066.33
600	1993.83	2054.57	2115.27	2176.02

**Components** **A**

3825 Clamp, 10, 100.

**2189 Gear**  
2230 Endpiece, white or grey.  
2759 Rod.  
5130 Belt.  
2242 Connector.  
2746 Detachable crank handle.  
2156 Drive shaft.  
3181 Bracket (single clamp)  
2139 Bracket (double clamp)  
2248 Cross rod.

**Bending** Max. trade discount **25%**  
Add the following to above system price:

Radius/cm	Single System	Double System
25-99	£329.00	£659.00
Over 99	£625.00	£1250.50

Standard angle radius 20cm.

**Bending** Max. trade discount **25%**  
discount Add the following to above system price:

Radius/cm	Single System	Double System	Treble System
25-99	£329.00	£659.00	£988.00
over 99	£625.00	£1250.50	£1886.50

Standard angle radius 20cm.

**SG 2195**  
Electrically Operated  
For curved, sloping or horizontal Roman blinds.

20cm std.

**SG 2195 Electrically Operated** **C**

Total max. curtain weight 25kg. (including cross profiles). Max. width: 3m. Max. drop: 6m.  
Max. total surface area 15m² depending on curtain weight.  
System 2195 is also available as a double and treble system with 2190 as a slave system.  
Max width achievable with double system: 6m, with treble system: 6m, other max. data as above.  
Profile 2191 can be bent to a 20cm min. radius.  
Supplied complete, hardware only, partially assembled including recessed switch and cross rods.  
Profile as standard in silver or white. For complete system cost please add price for fabric.  
See page 94 for Radio Control options.

**Single System Prices**

Width > Drop (cms)	Silver or White				
	Up to 100cms	101cms-150cms	151cms-200cms	201cms-250cms	251cms-300cms
150	2724.61	2788.21	2851.85	2915.46	2979.06
200	2839.50	2903.18	2966.79	3030.42	3094.11
250	2954.51	3018.10	3081.71	3145.29	3208.94
300	3069.46	3133.01	3196.66	3260.27	3323.87
350	3184.40	3247.99	3311.59	3375.20	3438.81
400	3299.26	3362.91	3426.59	3490.17	3553.78
450	3414.24	3477.89	3541.51	3605.05	3668.68
500	3529.16	3592.79	3656.43	3720.03	3783.68
550	3644.15	3707.75	3771.38	3834.96	3898.65
600	3759.07	3822.68	3886.34	3949.93	4013.57

**Double System Prices**

Width > Drop (cms)	Silver or White		
	Up to 200cms	201 cms-300 cms	301cms-400cms
150	3402.44	3526.86	3651.20
200	3627.14	3751.41	3875.87
250	3851.81	3976.16	4100.54
300	4076.50	4200.91	4325.19
350	4301.10	4425.49	4549.82
400	4525.80	4650.17	4774.45
450	4750.41	4874.78	4999.12
500	4975.08	5099.45	5223.79
550	5199.73	5324.12	5448.41
600	5424.45	5548.77	5673.07

**Treble System Prices**

Width > Drop (cms)	Silver or White		
	Up to 300cms	301 cms-400 cms	401cms-500cms
150	3895.35	4080.39	4265.47
200	4229.62	4414.78	4599.85
250	4564.07	4749.22	4934.23
300	4898.39	5083.44	5268.65
350	5232.79	5417.85	5602.97
400	5567.12	5752.23	5937.31
450	5901.58	6086.60	6271.70
500	6235.86	6421.01	6606.06
550	6570.29	6755.40	6940.45
600	6904.60	7089.70	7274.83

**Components** **A**

3825 Clamp, 10, 100

**2230 Set, white or grey**  
5130 Belt  
2160 Motor  
2759 Cross Rod  
2242 Connector  
2156 Drive Shaft  
2248 Cross Rod  
2145 Telescopic glider  
3181 Bracket (single clamp) silver or white  
2139 Bracket (double clamp) silver or white

**Bending** Max. trade discount **25%**  
discount Add the following to above system price:

Radius/cm	Single System	Double System	Treble System
25-99	£329.00	£659.00	£988.00
over 99	£625.00	£1250.50	£1886.50

Standard angle radius 20cm.

Made-to-measure Roman blinds for system 2190 and 2195

**Fabric for curved, sloping or horizontal Skylight Systems 2190/2195.** **C**

Made-to-measure Roman Blind for Systems 2190/2195.

Prices for made-up-blind, without hardware, per square metre.

Aluscreen Futura	£312.50 m²
Colorama Acoustic	£233.00 m²
Colorama Acoustic Multicolour	£233.00 m²
Colorama Dimout	£312.50 m²
Colorama 1	£196.00 m²
Colorama 1 Alu	£270.50 m²
Colorama 1 Bioactive	£233.00 m²
Colorama 1 Eco	£233.00 m²
Colorama 1 Multicolour	£233.00 m²
Colorama 2	£270.50 m²
Colorama 2 Bioactive	£270.50 m²
Colorama 2 Eco	£270.50 m²
Colorama 2 Multicolour	£270.50 m²
Leviso	£233.00 m²
Leviso Light	£233.00 m²
Multiscreen 5%	£291.50 m²
Multiscreen 10%	£291.50 m²
Oscurante	£233.00 m²
Reflex	£214.50 m²
Triscreen 1%	£291.50 m²
Triscreen 3%	£291.50 m²
Triscreen 5%	£291.50 m²
Versascreen 5%	£291.50 m²
Versascreen 10%	£291.50 m²

All prices shown exclude VAT

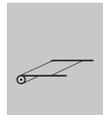

# Skylight Systems

## SG 8600

Electrically Operated  
tension roller blind.

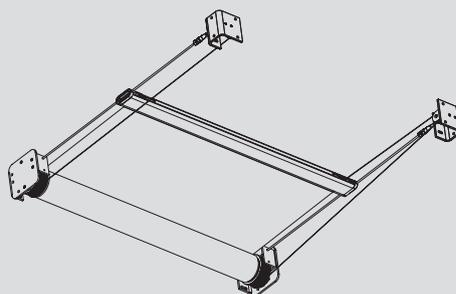

### SG 8600

Electrically operated tensioned roller blind system.  
Max. width: 4m. Max. drop: 6.5m

SG 8600 with Basicscreen 5% / Multiscreen 5% / Versascreen 5%

Price Category 'C'

Width Drop	110cm	150cm	200cm	250cm	300cm	350cm	400cm	Width Drop
100	3290.17	3322.89	3557.94	3591.14	3818.60	3859.47	3900.33	100
150	3324.79	3370.05	3620.84	3669.74	3912.96	3986.77	4026.09	150
200	3359.35	3417.19	3683.71	3748.37	4007.22	4079.59	4151.87	200
250	3393.94	3464.39	3746.59	3826.93	4101.59	4189.63	4277.68	250
300	3428.54	3511.50	3809.47	3905.56	4195.90	4299.70	4403.44	300
350	3613.37	3708.95	4015.00	4134.51	4444.29	4559.93	4679.42	350
400	3647.93	3756.11	4077.87	4213.09	4573.15	4670.00	4805.22	400
450	3682.51	3803.26	4140.75	4291.72	4629.14	4780.07	4930.98	450
500	3717.11	3850.45	4203.67	4370.33	4723.43	4890.09		500
550	3751.69	3897.60	4266.55	4448.92	4817.77	5000.14		550
600	3786.30	3944.78	4329.45	4527.56	4912.07			600
650	3820.88	3991.91	4392.33	4606.13	5006.42			650

SG 8600 with Aluscreen Futura / Safescreen

Price Category C

Width Drop	110cm	150cm	200cm	250cm	300cm	350cm	400cm	Width Drop
100	3326.11	3371.90	3623.24	3673.17	3916.58	3974.14	4030.97	100
150	3374.50	3437.83	3711.24	3782.74	4048.53	4127.77	4206.97	150
200	3422.93	3503.86	3799.24	3892.78	4180.57	4281.76	4382.96	200
250	3471.32	3608.23	3887.24	3964.42	4312.53	4435.75	4559.00	250
300	3519.69	3635.86	3975.24	4112.79	4444.57	4589.57	4734.96	300
350	3718.30	3852.12	4205.90	4373.08	4726.78	4894.39	5061.19	350
400	3766.73	3918.14	4294.26	4483.07	4858.79	5047.97	5237.18	400
450	3815.14	3984.11	4381.90	4593.05	4990.81	5201.96	5413.19	450
500	3863.55	4050.08	4469.89	4703.10	5122.78	5356.00		500
550	3911.93	4116.13	4557.89	4813.08	5254.81	5510.00		550
600	3998.69	4182.10	4645.88	4923.11	5386.78			600
650	4008.74	4248.08	4733.85	5033.09	5518.78			650

Motor is fitted as standard to the left. Should you require a right hand motor there will be an additional cost of £239.77.

Profiles are standard in white (RAL 9016). Alternative standard RAL colours are available at a cost of £359.00 (per system, nett, Cat E).

All prices shown exclude VAT



# Skylight Systems

## SG 8640

Electrically Operated  
Tensioned roller blind with  
fabric edge retention.

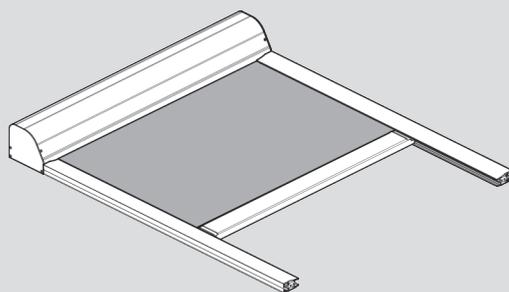

### SG 8640

Minimum width 650mm. Max width 3000mm  
Maximum length 4500mm. Systems over 3000mm length use a larger barrel & headbox.  
Please see catalogue for sizing limitations.  
\*Width restrictions apply, see below.

Price Group 1 – Nox, Mercurio, Multiscreen 1% / 5% and Versascreen 1% / 5%

Price Category 'C'

Width Drop	100cm	150cm	200cm	250cm	300cm	Width Drop
150	4344.19	4723.17	4942.36	5298.70	5517.88	150
200	4627.47	5079.53	5371.75	5801.16	6093.41	200
250	4773.59	5298.70	5664.00	6166.48	6531.75	250
300	4919.71	5517.88	5956.24	6531.75	6970.13	300
350	5203.00	5874.22	6385.64	7034.22	7545.64	350
400	5349.12	6093.41	6677.88	7399.54	7983.99	400
450	5495.25	6312.58	6970.13	7764.82	8422.37	450

Price Group 2 – Aluscreen Futura and Moon

Width Drop	100cm	150cm	200cm	250cm	300cm	Width Drop
150	4429.56	4851.23	5113.07	5512.11	5773.97	150
200	4741.28	5250.24	5599.39	6085.69	6958.57	200
250	4893.67	5512.11	5948.53	6522.14	6958.57	250
300	5090.43	5773.97	6297.68	6958.57	7482.28	300
350	5402.18	6172.99	6783.98	7532.15	8143.16	350
400	5576.74	6434.85	7133.25	7968.59	8666.88	400
450	5751.33	6696.70	7482.28	8405.02	9190.60	450

3.0 x 3.0m max in any orientation.

\*Max 2.5m wide x 4.5m long / 11m<sup>2</sup> greater than 30° from vertical.

White Hardware available as standard (RAL 9016 white). Alternative standard RAL colours are available at a cost of £359.00 (per system, nett, Cat E).

For use with remote, please see page 28 for external receivers and remote control options. Details on compatible receivers and remotes can be found on page 93 – 94.

All prices shown exclude VAT



# Vertical Blinds

## Vertical Waves by Eva Marmbrandt

Suitable for use on systems 2810, 2900, 2950. Not applicable for sloping systems.

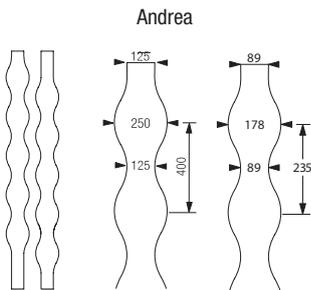

**Vertical Waves**  
Fabric Price Group 2  
Made in Multi Visio and Multi Shadow

Minimum and maximum system length as per individual system information.  
Minimum louvre drop 104cm (127mm)  
Maximum louvre drop 423cm (127mm)

Minimum louvre drop 110cm (89mm)  
Maximum louvre drop 364cm (89mm)

Minimum distance from wall 140mm  
Can be bent to large radius >6m.

Available as 89mm or 127mm louvres.

**3D Vertical Wave**  
Fabric Price Group 3 + 20% + Set up charge  
Made in Multi Visio  
Drop must be between 2.18m-2.97m

## SG 2810

Profile only 2601 available in 6 metre lengths.  
Headrail available in silver and white.

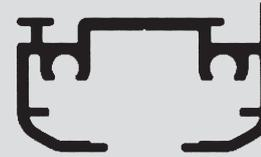
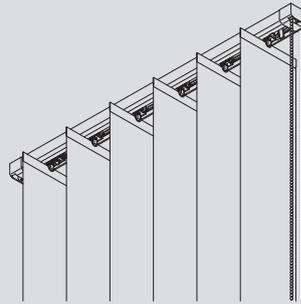

75cm std.

## SG 2810 Track and Accessories only

Maximum system width 5m (127mm) or 3.8m (89mm).

For guidance the following number of louvres per metre should be calculated:  
127mm/5" 10/metre  
89mm/3 1/2" 13/metre

**Track system only complete, assembled, ready to hang.**

Hardware only: in silver or white, no fabrics. Excluding bottom weights and link chain but including Top clips and 2616 bracket clamps. Operating chain 150cm standard. Wall fix brackets extra. Prices given are for 127mm/5" louvres. For 89mm/3 1/2" louvres add 15%.

Width up to cm	£	Price Ctgy.
60	119.70	C
80	141.88	
100	164.07	
120	186.26	
140	208.40	
160	230.55	
180	252.67	
200	274.84	
220	297.01	
240	319.20	
260	341.22	
280	363.45	
300	385.63	
320	407.76	
340	429.95	
360	452.10	
380	474.21	
400	496.39	
420	518.58	
440	540.77	
460	562.94	
480	585.15	
500	607.37	

### Standard Accessories

- 2601 Profile only, silver or white.
- 2604 Guide.
- 2605 Top clip 127mm white.
- 2608 Endstop for 2601.
- 2610 Endstop.
- 2611 Stopper.
- 2616 Bracket.
- 2620 Pilot runner.
- 2623 Rotation element (123mm).
- 2625 Rotation element (89mm).
- 2813 Top clip 89mm white.
- 2865 Bead chain connector.
- 2872 Plastic operating chain.
- 10731 Cord tidy

	Price Ctgy.	
<b>Optional Accessories</b> (Additional Charges May Apply) 2471 Bottom weight 127mm. 2473 Bottom weight 89mm. 2479 Louvre connecting chain 127mm. 2481 Louvre connecting chain 89mm. 2606 Top clip 127mm (modified). 2607 Top clip 89mm (modified). 2615 Recess profile. 2618 Shaft. 2624 Adjustment element (101mm). 2824 Spacer (65mm). 5118 Wedge. 2872 Operating chain black	C	
<b>Smart Fix Bracket Covers</b> 11116 Smart Fix Bracket Cover. 11137 Square Smart Fix Bracket Cover.	A	
<b>Smart Fix Brackets in white, black or silver</b> 11118 Smart Fix 60mm Bracket (11200 Set). 11119 Smart Fix 80mm Bracket (11201 Set). 11120 Smart Fix 100mm Bracket (11202 Set). 11121 Smart Fix 120mm Bracket (11203 Set). 11122 Smart Fix 150mm Bracket (11204 Set). 11123 Smart Fix 200mm Bracket (11205 Set).	C	
<b>Square Smart Fix Brackets in white, black or silver</b> 11139 Smart Fix 60mm Bracket (11210 Set). 11140 Smart Fix 80mm Bracket (11211 Set). 11141 Smart Fix 100mm Bracket (11212 Set). 11142 Smart Fix 120mm Bracket (11213 Set). 11143 Smart Fix 150mm Bracket (11214 Set). 11144 Smart Fix 200mm Bracket (11215 Set).		
<b>Bends</b> Max trade discount 25%		25%
Radius/cm Profile 2601 75 £100.50 Standard angle bend radius Over 75 £206.50		

	Price Ctgy.
<b>*3D Vertical Waves</b> £431.79 set up charge. Please add to assembled prices Made in Multi Visio 127mm Andrea Design only.	E
<b>Printing Information</b> All RAL colours applicable (except white, pearl and fluorescent colours). Height 218cm to 297cm 5 shape louvre and 6 shape louvre.	
<b>Fabric price categories</b> For SG 2810 complete with fabrics (see tables over)	
<b>Price Group 1</b> Element Function Multi Shadow Multi Visio	
<b>Price Group 2</b> Alutex Colorama 2 Mercurio Multiscreen 5% Versascreen 1% Versascreen 2% Versascreen 5% Versascreen 10% Vertical Wave (Multi Visio, Multi shadow)	
<b>Price Group 3</b> Colorama 2 Bioactive Moon Reflex 3D Vertical Wave (Multi Visio)* + 20% + Set up charge	
All fabrics are available in 89mm and 127mm louvres (89mm add 15%). All above fabrics are FR.	

All prices shown exclude VAT







# Vertical Blinds

## SG 2950

Profile 2901

50cm std.

### SG 2950

#### Electrically Operated Vertical Blind System

Track system complete, assembled, ready to hang.

Min. system width: 110cm  
Max. system width: 600cm  
Available in 127mm and 89mm systems.  
Supplied with recess switch 0565 for open/close/tilt operation. Silver or white at same cost.

	Price Ctg.
<b>Pricing for SG 2950</b> Add to relevant hardware or hardware and fabric price over:	<b>C</b>
2950 £862.69	
2950R £1147.40 (Integrated Receiver)	

SG 0450 Radio Controls is also suitable for use with SG 2950.

**C**

	Price Ctg.
<b>Accessories</b>	<b>C</b>
2901 Profile, silver or white.	
9117 Set.	
2912 Belt.	
2925 Belt connector.	
2927 Pilot runner.	
3033 Clamp.	
9091 Motor	

Bends	Max. trade discount	25%
Radius cm	Profile 2901	
50-99	£162.00	
Standard angle bend radius 50cm		
Over 99	£308.50	

Colours	Price Ctg.
Other colours special order – see page 75.	<b>E</b>

**Pricing Examples** 2950 200cm width, straight hardware only:

2900 +per system £651.44 +£862.69 = £1514.13

Note: Price based on 127mm/5" system.

## SG 2900

Profile 2901 available in 6 metre lengths only. Headrail available in silver and white.

Profile 2901

50cm std.

### SG 2900 Track and Accessories only

Track system only complete, assembled, ready to hang.

Min. system width: 50cm  
Max. system width: 600cm

Width up to cm	£	Width up to cm/ft.ins.	£
120	469.90	300	878.27
140	515.27	320	923.64
160	560.69	340	968.99
180	606.07	360	1014.43
200	651.44	380	1059.77
220	696.80	400	1105.15
240	742.20	420	1150.55
260	787.60	440	1195.88
280	832.86	460	1241.23

	Price Ctg.
<b>Accessories</b>	<b>C</b>
2605 Top clip 127mm each, white.	
2813 Top clip 89mm each, white.	
2735 Nylon weight hook, each, 100.	
2746 Detachable crank handle (standard).	
2824 Endstop, each, 10.	
2471 Bottom weight 127mm.	
2473 Bottom weight 89mm.	
2479 Bottom link cord 127mm.	
2481 Bottom link cord 89mm.	
2901 Profile, per metre.	
2912 Drive belt.	
2916 Rotation element 127 mm.	
2918 Rotation element 89mm.	
2920 Endpiece set, white or grey.	
2925 Belt Connector.	
2927 Pilot runner, each	
3033 Clamps set of 10, 100.	
2849 Top clip for PVC per 100.	
2962 Connecting bridge.	

	Price Ctg.
2671 Bottom weight 89mm without horns.	<b>A</b>
2672 Bottom weight 127mm without horns.	
1148C Screw 31mm/1 1/4" No. 8 counter sunk, 100.	
<b>Universal Smart Fix Extension Bracket in white, black or silver</b>	
11154 Universal Smart Fix 120mm.	
11155 Universal Smart Fix 150mm.	
11156 Universal Smart Fix 200mm.	

Hardware only, no fabric. Excluding bottom weight and link cord but including 2605 top clips and 3033 top fix clamps. Operating handle 150cm drop as standard. Wall fixing brackets extra (see below) Prices given are for 127mm/5" louvres. Sloping window+50%. For 89mm/3 1/2" louvres, add 15%. Silver or white at same cost.

Width up to cm/ft.ins.	£
480	1286.64
500	1331.96
520	1377.39
540	1422.70
560	1468.15
580	1513.52
600	1558.87

	Price Ctg.
<b>Colours</b>	<b>E</b>
Other colours special order –see page 74	
<b>Bends</b>	<b>25%</b>
Radius/cm	Profile 2901
50-99	£162.00
Standard angle bend radius 50cm	
Over 99	£308.50

**N.B.**  
For guidance the following number of louvres per metres should be calculated:  
89mm : 13/metre  
127mm : 10/metre

**\*3D Vertical Waves**  
£431.79 set up charge.  
Please add to assembled prices. Made in Multi Visio Colour 1 127mm Andrea Design only.

**Printing Information**  
All RAL colours applicable (except white, pearl and fluorescent colours). Height 218cm to 297cm  
5 shape louvre and 6 shape louvre.

### Fabric price categories

For SG 2900 complete with fabrics (see tables over)

Price Group 1	Price Ctg.
Element	<b>E</b>
Function	
Multi Shadow	
Multi Visio	

Price Group 2	Price Ctg.
Alutex	
Colorama 2	
Mercurio	
Multiscreen 5%	
Versascreen 1%	
Versascreen 2%	
Versascreen 5%	
Versascreen 10%	
Vertical Wave (excl. sloping systems)	

Price Group 3	Price Ctg.
Colorama 2 Bioactive	
Moon	
Reflex	
3D Vertical Wave (Multi Visio)* + 20% + set up charge.	

All fabrics are available in 89mm and 127mm louvres (89mm add 15%).  
All above fabrics are FR

All prices shown exclude VAT



# SG 2900 complete with fabric

The prices below comprise complete system, silver or white ready-to-hang, top fix, single or pair stack with fabric choice in 127mm/5" louvres (see fabric price categories), includes bottom weights and bottom link cord to both sides, 150cm drop operating crank handle. Wall fix brackets extra. For 89mm/3 1/2" louvres add 15%. If sizes lie between the measurements shown, the price for the next larger size will apply. Set up costs apply for 3D vertical waves.

Price Category C

Width cm	UP TO 120			UP TO 140			UP TO 160		
	1	2	3	1	2	3	1	2	3
Drop cm									
60	596.42	638.07	683.28	654.78	703.39	756.13	713.08	768.63	828.90
80	611.50	667.03	727.26	672.33	737.11	807.49	733.17	807.21	887.55
100	626.52	696.07	771.31	689.94	770.93	858.81	753.24	845.90	946.25
120	641.62	724.94	815.21	707.44	804.68	910.09	773.30	884.48	1004.92
140	656.62	753.92	859.34	725.00	838.47	961.42	793.37	923.06	1063.57
160	671.69	782.85	903.29	742.58	872.28	1012.76	813.45	961.65	1122.18
180	686.76	811.80	947.29	760.19	906.02	1064.17	833.54	1000.26	1180.89
200	701.82	840.78	991.33	777.70	939.85	1115.45	853.59	1038.83	1239.55
220	716.93	869.62	1035.28	795.33	973.60	1166.76	873.71	1077.48	1298.26
240	731.96	898.59	1079.33	812.82	1007.31	1218.14	893.80	1116.06	1356.94
260	746.93	927.63	1123.29	830.37	1041.13	1269.46	913.84	1154.67	1415.62
280	762.04	956.55	1167.35	847.96	1074.87	1320.78	933.90	1193.25	1474.32
300	777.12	985.54	1211.35	865.51	1108.68	1372.15	953.90	1231.83	1532.90
320	792.17	1014.44	1255.33	883.12	1142.47	1423.45	974.04	1270.41	1591.64
340	807.19	1043.39	1299.36	900.68	1176.18	1474.81	994.14	1309.11	1650.30
360	822.23	1072.34	1343.35	918.24	1210.02	1526.15	1014.18	1347.66	1708.96
380	837.34	1101.26	1387.35	935.80	1243.72	1577.50	1034.30	1386.27	1767.69
400	852.40	1130.22	1431.34	953.35	1277.54	1628.88	1054.37	1424.83	1826.30

Width cm	UP TO 180			UP TO 200			UP TO 220		
	1	2	3	1	2	3	1	2	3
Drop c									
60	771.42	833.95	901.68	829.80	899.19	974.49	888.06	964.51	1047.27
80	793.97	877.38	967.65	854.84	947.45	1047.92	915.70	1017.61	1127.94
100	816.53	920.78	1033.70	879.88	995.67	1121.12	943.26	1070.64	1208.65
120	839.18	964.15	1099.69	905.02	1043.95	1194.50	970.89	1123.68	1289.34
140	861.75	1007.64	1165.72	930.13	1092.17	1267.87	998.48	1176.81	1370.00
160	884.31	1051.04	1231.72	955.23	1140.47	1341.22	1026.04	1229.83	1450.62
180	906.90	1094.49	1297.75	980.32	1188.72	1414.53	1053.68	1282.96	1531.31
200	929.50	1137.88	1363.72	1005.44	1236.92	1487.89	1081.27	1335.98	1612.02
220	952.11	1181.31	1429.71	1030.51	1285.23	1561.22	1108.88	1389.07	1692.68
240	974.66	1224.77	1495.77	1055.59	1333.41	1634.56	1136.49	1442.14	1773.33
260	997.26	1268.14	1561.73	1080.68	1381.75	1707.86	1164.13	1495.21	1854.06
280	1019.79	1311.58	1627.78	1105.76	1429.94	1781.25	1191.72	1548.27	1934.68
300	1042.45	1355.03	1693.80	1130.84	1478.17	1854.54	1219.28	1601.32	2015.42
320	1065.02	1398.45	1759.78	1155.95	1526.46	1927.91	1246.93	1654.38	2096.11
340	1087.57	1441.88	1825.75	1181.02	1574.69	2001.24	1274.52	1707.48	2176.75
360	1110.17	1485.33	1891.78	1206.17	1622.92	2074.60	1302.13	1760.56	2257.40
380	1132.79	1528.71	1957.79	1231.29	1671.17	2147.93	1329.72	1813.59	2338.06
400	1155.27	1572.11	2023.82	1256.34	1719.41	2221.26	1357.28	1866.71	2418.77

Width cm	UP TO 240			UP TO 260			UP TO 280		
	1	2	3	1	2	3	1	2	3
Drop cm									
60	946.42	1029.78	1120.13	1004.73	1095.01	1192.87	1063.06	1160.32	1265.70
80	976.50	1087.60	1208.15	1037.35	1157.73	1288.22	1098.16	1227.81	1368.34
100	1006.64	1145.54	1296.08	1069.95	1220.44	1383.59	1133.31	1295.41	1471.05
120	1036.75	1203.46	1384.08	1102.58	1283.17	1478.93	1168.47	1362.97	1573.75
140	1066.77	1261.34	1472.13	1135.22	1345.94	1574.28	1203.59	1430.49	1676.42
160	1096.96	1319.21	1560.16	1167.79	1408.66	1669.64	1238.69	1498.04	1779.05
180	1127.07	1377.17	1648.14	1200.46	1471.37	1764.92	1273.80	1565.59	1881.79
200	1157.17	1435.04	1736.23	1233.08	1534.04	1860.29	1308.96	1633.15	1984.42
220	1187.31	1492.92	1824.11	1265.70	1596.80	1955.70	1344.15	1700.65	2087.13
240	1217.35	1550.77	1912.12	1298.29	1659.55	2050.95	1379.25	1768.22	2189.78
260	1247.50	1608.75	2000.18	1330.93	1722.26	2146.38	1414.37	1835.79	2292.48
280	1277.63	1666.61	2088.15	1363.56	1784.97	2241.66	1449.48	1903.25	2395.17
300	1307.72	1724.59	2176.22	1396.16	1847.68	2336.98	1484.59	1970.87	2497.79
320	1337.89	1782.42	2264.22	1428.78	1910.38	2432.34	1519.78	2038.42	2600.54
340	1367.92	1840.33	2352.21	1461.44	1973.17	2527.67	1554.92	2105.99	2703.13
360	1398.08	1898.22	2440.19	1494.07	2035.89	2623.03	1590.01	2173.49	2805.86
380	1428.17	1956.16	2528.16	1526.62	2098.61	2718.36	1625.14	2241.02	2908.51
400	1458.25	2014.02	2616.23	1559.28	2161.29	2813.66	1660.24	2308.58	3011.18

All prices shown exclude VAT



# SG 2900 complete with fabric

The prices below comprise complete system, silver or white ready-to-hang, top fix, single or pair stack with fabric choice in 127mm/5" louvres (see fabric price categories). Includes bottom weights and bottom link cord to both sides, 150cm drop operating crank handle. Wall fix brackets extra. For 89mm/3-1/2" louvres add 15%. If sizes lie between the measurements shown, the price for the next larger size will apply. Set up costs apply for 3D vertical waves.

Price Category C

Width cm	UP TO 300			UP TO 320			UP TO 340		
	1	2	3	1	2	3	1	2	3
Drop cm									
60	1121.41	1225.58	1338.46	1179.71	1290.81	1411.33	1238.07	1356.11	1484.11
80	1158.98	1298.00	1448.52	1219.87	1368.03	1528.62	1280.70	1438.11	1608.82
100	1196.64	1370.35	1558.53	1259.98	1445.25	1646.02	1323.38	1520.18	1733.46
120	1234.27	1442.70	1668.48	1300.17	1522.42	1763.34	1366.02	1602.15	1858.14
140	1271.89	1515.10	1778.60	1340.32	1599.62	1880.72	1408.68	1684.26	1982.78
160	1309.58	1587.45	1888.56	1380.44	1676.81	1997.97	1451.32	1766.24	2107.45
180	1347.22	1659.80	1998.58	1420.62	1754.06	2115.35	1493.97	1848.27	2232.18
200	1384.84	1732.18	2108.55	1460.81	1831.20	2232.71	1536.65	1930.31	2356.84
220	1422.49	1804.55	2218.57	1500.92	1908.42	2350.07	1579.33	2012.29	2481.54
240	1460.14	1876.87	2328.63	1541.06	1985.62	2467.42	1621.97	2094.30	2606.22
260	1497.76	1949.25	2438.59	1581.15	2062.80	2584.74	1664.60	2176.34	2730.90
280	1535.44	2021.69	2548.65	1621.34	2140.03	2702.09	1707.29	2258.32	2855.61
300	1573.06	2094.05	2658.64	1661.50	2217.23	2819.46	1749.96	2340.42	2980.23
320	1610.73	2166.41	2768.61	1701.67	2294.43	2936.73	1792.60	2422.38	3104.93
340	1648.32	2238.79	2878.64	1741.81	2371.60	3054.09	1835.20	2504.39	3229.58
360	1686.00	2311.13	2988.66	1781.90	2448.83	3171.45	1877.91	2586.47	3354.27
380	1723.58	2383.51	3098.66	1822.10	2526.00	3288.85	1920.57	2668.46	3478.93
400	1761.30	2455.87	3208.64	1862.25	2603.27	3406.20	1963.24	2750.49	3603.62

Width cm	UP TO 360			UP TO 380			UP TO 400		
	1	2	3	1	2	3	1	2	3
Drop cm									
60	1296.36	1421.38	1556.88	1354.73	1486.68	1629.73	1412.99	1551.93	1702.54
80	1341.54	1508.28	1688.91	1402.39	1578.33	1769.01	1463.21	1648.45	1849.19
100	1386.70	1595.12	1820.90	1450.07	1670.02	1908.41	1513.34	1744.96	1995.88
120	1431.85	1681.94	1952.98	1497.74	1761.67	2047.75	1563.55	1841.42	2142.55
140	1477.08	1768.81	2084.99	1545.44	1853.35	2187.06	1613.78	1937.89	2289.22
160	1522.19	1855.65	2216.96	1593.06	1945.00	2326.39	1663.98	2034.45	2435.92
180	1567.35	1942.45	2348.97	1640.74	2036.71	2465.78	1714.12	2130.90	2582.59
200	1612.48	2029.31	2480.96	1688.42	2128.36	2605.10	1764.35	2227.41	2729.28
220	1657.74	2116.13	2612.98	1736.13	2220.07	2744.51	1814.50	2323.93	2875.96
240	1702.85	2203.08	2745.07	1783.78	2311.70	2883.78	1864.70	2420.40	3022.60
260	1748.04	2289.85	2877.06	1831.51	2403.37	3023.19	1914.90	2516.89	3169.33
280	1793.21	2376.68	3009.02	1879.12	2495.04	3162.57	1965.08	2613.35	3315.99
300	1838.37	2463.53	3141.07	1926.84	2586.70	3301.85	2015.26	2709.88	3462.60
320	1883.55	2550.42	3273.10	1974.48	2678.36	3441.28	2065.44	2806.42	3609.37
340	1928.72	2637.28	3405.08	2022.18	2770.06	3580.55	2115.62	2902.89	3756.00
360	1973.85	2724.08	3537.12	2069.85	2861.74	3719.89	2165.81	2999.33	3902.74
380	2019.04	2810.93	3669.07	2117.48	2953.36	3859.23	2215.96	3095.83	4049.44
400	2064.22	2897.77	3801.12	2165.21	3045.10	3998.60	2266.15	3192.33	4196.13

Width cm	UP TO 420			UP TO 440			UP TO 460		
	1	2	3	1	2	3	1	2	3
Drop cm									
60	1471.35	1617.21	1775.31	1529.73	1682.51	1848.08	1588.01	1747.72	1920.90
80	1524.03	1718.55	1929.35	1584.90	1788.62	2009.48	1645.75	1858.80	2089.55
100	1576.73	1819.83	2083.36	1640.10	1894.76	2170.85	1703.38	1969.74	2258.28
120	1629.44	1921.21	2237.38	1695.33	2000.88	2332.16	1761.11	2080.69	2426.99
140	1682.14	2022.50	2391.39	1750.51	2107.07	2493.57	1818.90	2191.65	2595.62
160	1734.83	2123.78	2545.39	1805.71	2213.22	2654.87	1876.59	2302.60	2764.36
180	1787.52	2225.15	2699.37	1860.87	2319.36	2816.25	1934.30	2413.60	2933.02
200	1840.21	2326.40	2853.39	1916.13	2425.53	2977.56	1992.01	2524.55	3101.70
220	1892.94	2427.82	3007.42	1971.37	2531.64	3138.93	2049.71	2635.57	3270.40
240	1945.62	2529.07	3161.45	2026.50	2637.79	3300.25	2107.43	2746.43	3439.07
260	1998.33	2630.46	3315.40	2081.76	2743.94	3461.60	2165.16	2857.48	3607.74
280	2050.98	2731.76	3469.44	2136.91	2850.06	3622.96	2222.85	2968.44	3776.41
300	2103.69	2833.09	3623.50	2192.13	2956.22	3784.34	2280.61	3079.42	3945.08
320	2156.40	2934.37	3777.48	2247.36	3062.35	3945.65	2338.28	3190.41	4113.83
340	2209.06	3035.70	3931.55	2302.51	3168.47	4106.96	2396.01	3301.36	4282.50
360	2261.72	3136.96	4085.53	2357.73	3274.67	4268.37	2453.69	3412.28	4451.17
380	2314.50	3238.32	4239.59	2412.96	3380.79	4429.73	2511.39	3523.32	4619.85
400	2367.17	3339.68	4393.59	2468.15	3486.97	4591.07	2569.15	3634.22	4788.57

All prices shown exclude VAT



# SG 2900 complete with fabric

The prices below comprise complete system, silver or white ready-to-hang, top fix, single or pair stack with fabric choice in 127mm/5" louvres (see fabric price categories). Includes bottom weights and bottom link cord to both sides, 150cm drop operating crank handle. Wall fix brackets extra. For 89mm/3 1/2" louvres add 15%. If sizes lie between the measurements shown, the price for the next larger size will apply. Set up costs apply for 3D vertical waves.

Price Category C

Width cm	UP TO 480			UP TO 500			UP TO 520		
	1	2	3	1	2	3	1	2	3
Drop cm									
60	1646.37	1813.10	1993.78	1704.60	1878.32	2066.57	1762.94	1943.59	2139.25
80	1706.60	1928.83	2169.76	1767.37	1998.88	2249.85	1828.27	2069.06	2330.01
100	1766.80	2044.66	2345.70	1830.07	2119.57	2433.21	1893.45	2194.47	2520.69
120	1826.99	2160.45	2521.78	1892.88	2240.15	2616.58	1958.71	2319.91	2711.42
140	1887.22	2276.23	2697.76	1955.59	2360.80	2799.95	2023.95	2445.41	2902.10
160	1947.47	2392.04	2873.79	2018.29	2481.44	2983.24	2089.20	2570.79	3092.79
180	2007.64	2507.80	3049.84	2081.05	2602.06	3166.60	2154.44	2696.28	3283.43
200	2067.90	2623.53	3225.82	2143.75	2722.69	3349.94	2219.65	2821.70	3474.14
220	2128.12	2739.40	3401.88	2206.57	2843.26	3533.32	2284.93	2947.13	3664.78
240	2188.34	2855.20	3577.88	2269.29	2963.93	3716.66	2350.16	3072.59	3855.47
260	2248.60	2970.97	3753.92	2331.99	3084.47	3900.02	2415.40	3198.05	4046.15
280	2308.75	3086.78	3929.91	2394.71	3205.12	4083.35	2480.68	3323.52	4236.82
300	2369.03	3202.58	4105.90	2457.45	3325.74	4266.72	2545.91	3448.92	4427.50
320	2429.27	3318.38	4281.97	2520.21	3446.34	4450.16	2611.14	3574.36	4618.27
340	2489.46	3434.16	4457.93	2582.93	3566.97	4633.42	2676.40	3699.82	4808.89
360	2549.70	3550.00	4634.02	2645.66	3687.64	4816.79	2741.64	3825.28	4999.56
380	2609.91	3665.74	4810.04	2708.35	3808.21	5000.12	2806.90	3950.70	5190.24
400	2670.10	3781.52	4986.03	2771.07	3928.90	5183.54	2872.10	4076.15	5380.98

Width cm	UP TO 540			UP TO 560			UP TO 580		
	1	2	3	1	2	3	1	2	3
Drop cm									
60	1821.31	2008.89	2212.14	1879.60	2074.12	2284.93	1937.98	2139.42	2357.69
80	1889.07	2139.15	2410.18	1949.90	2209.27	2490.27	2010.69	2279.34	2570.45
100	1956.83	2269.42	2608.18	2020.17	2344.35	2695.60	2083.53	2419.20	2783.06
120	2024.62	2399.63	2806.17	2090.40	2479.37	2900.98	2156.28	2559.21	2995.80
140	2092.28	2529.92	3004.18	2160.70	2614.53	3106.36	2229.06	2699.07	3208.44
160	2160.07	2660.22	3202.24	2230.97	2749.61	3311.69	2301.83	2838.98	3421.14
180	2227.80	2790.46	3400.27	2301.21	2884.72	3517.04	2374.52	2978.95	3633.88
200	2295.61	2920.76	3598.27	2371.46	3019.75	3722.36	2447.34	3118.83	3846.46
220	2363.31	3051.06	3796.23	2441.75	3154.88	3927.82	2520.15	3258.79	4059.24
240	2431.07	3181.29	3994.29	2511.98	3290.00	4133.09	2592.92	3398.70	4271.86
260	2498.84	3311.57	4192.29	2582.24	3425.07	4338.45	2665.68	3538.63	4484.63
280	2566.59	3441.81	4390.35	2652.55	3560.22	4543.79	2738.41	3678.52	4697.33
300	2634.31	3572.10	4588.40	2722.75	3695.17	4749.22	2811.17	3818.46	4909.98
320	2702.09	3702.35	4786.35	2793.08	3830.40	4954.50	2884.00	3958.30	5122.73
340	2769.81	3832.62	4984.42	2863.27	3965.43	5159.89	2956.77	4098.26	5335.37
360	2837.60	3962.91	5182.39	2933.56	4100.54	5365.22	3029.54	4238.20	5548.05
380	2905.27	4093.15	5380.43	3003.78	4235.61	5570.62	3102.30	4378.08	5760.74
400	2973.05	4223.48	5578.47	3074.05	4370.72	5775.91	3175.00	4518.00	5973.45

Width cm	UP TO 600		
	1	2	3
Drop cm			
60	1996.27	2204.70	2430.48
80	2071.55	2349.43	2650.53
100	2146.86	2494.22	2870.62
120	2222.09	2638.90	3090.62
140	2297.40	2783.68	3310.65
160	2372.74	2928.44	3530.64
180	2448.05	3073.19	3750.61
200	2523.32	3217.90	3970.69
220	2598.56	3362.61	4190.73
240	2673.84	3507.38	4410.73
260	2749.14	3652.12	4630.72
280	2824.41	3796.87	4850.81
300	2899.65	3941.63	5070.79
320	2974.96	4086.34	5290.77
340	3050.23	4231.09	5510.88
360	3125.47	4375.87	5730.87
380	3200.73	4520.59	5950.87
400	3276.00	4665.35	6170.87

All prices shown exclude VAT



# Roller Blinds

## SG 4900

Spring operation with decelerator.  
Tube diameter 32.2mm

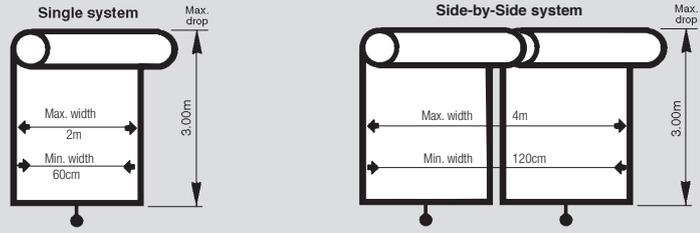

### System 4900 complete with fabric

The prices below comprise the complete system made-to-measure, ready-to-hang with fabric of your choice. Brackets, bracket covers, bottom bar and bottom bar endcaps supplied as standard in either white, grey or black. Operation as standard with pull-ball. Please consult application chart (page 57 of our main price list) to ensure that fabric chosen can be supplied in dimensions required. Grey and black accessories available as of 1st April 2023.

Price category C

#### Price Group 1R

**Basicscreen 5%**  
**Basicscreen 10%**  
Colorama 1  
Colorama 1 Alu  
Colorama 1 Bioactive  
Colorama 1 Eco  
Colorama 1 Multicolour  
Colorama Acoustic  
Colorama Acoustic Multicolour  
Element  
Puma

Width	60cm	80cm	100cm	120cm	140cm	160cm	180cm	200cm	Width
Drop cm									Drop cm
60	290.52	307.21	323.91	340.66	357.30	374.10	390.74	407.45	60
80	296.30	314.90	333.55	352.09	370.75	389.38	408.03	426.58	80
100	302.02	322.57	343.09	363.68	384.13	404.69	425.25	445.81	100
120	307.77	330.20	352.66	375.17	397.52	420.08	442.49	464.96	120
140	313.50	337.86	362.23	386.64	410.95	435.34	459.70	484.11	140
160	319.23	345.53	371.81	398.15	424.40	450.65	476.98	503.27	160
180	324.96	353.22	381.44	409.62	437.82	466.04	494.28	522.35	180
200	330.85	360.82	390.98	421.13	451.16	481.36	511.44	541.60	200
220	336.52	368.58	400.61	432.54	464.59	496.66	528.72	560.72	220
240	342.27	376.23	410.14	444.12	478.04	512.01	545.94	579.88	240
260	347.98	383.90	419.74	455.59	491.51	527.30	563.23	599.15	260
280	353.76	391.52	429.30	467.03	504.92	542.66	580.43	618.19	280
300	359.49	399.23	438.85	478.54	518.31	557.98	597.68	637.37	300

#### Price Group 2R

Alutex  
Colorama 2  
Colorama 2 Bioactive  
Colorama 2 Eco  
Colorama 2 Multicolour  
Mercurio  
Multi Visio  
Multishadow  
**Multiscreen 5%**  
**Multiscreen 10%**  
Newlifescreen  
Nox  
**Triscreen 5%**  
**Versascreen 5%**  
**Versascreen 10%**  
Moon  
Reflex  
Safescreen

Width	60cm	80cm	100cm	120cm	140cm	160cm	180cm	200cm	Width
Drop cm									Drop cm
60	301.50	321.82	342.13	362.51	382.90	403.20	423.58	443.90	60
80	310.82	334.33	357.82	381.32	404.78	428.23	451.71	475.22	80
100	320.27	346.84	373.49	400.03	426.63	453.30	479.92	506.51	100
120	329.63	359.38	389.14	418.92	448.65	478.33	508.07	537.83	120
140	339.03	371.90	404.78	437.65	470.54	503.44	536.29	569.11	140
160	348.46	384.44	420.37	456.45	492.45	528.45	564.41	600.44	160
180	357.82	396.9	436.04	475.22	514.42	553.52	592.62	631.75	180
200	367.19	409.45	451.71	493.98	536.29	578.51	620.78	663.09	200
220	376.59	421.95	467.34	512.78	558.20	603.56	648.94	694.38	220
240	386.01	434.47	483.10	531.56	580.11	628.6	677.17	725.74	240
260	395.41	447.04	498.69	550.34	602.01	653.64	705.30	756.95	260
280	404.78	459.58	514.42	569.11	623.87	678.71	733.49	788.26	280
300	414.20	472.05	530.00	587.92	645.83	703.72	761.66	819.59	300

#### Price Group 3R

**Aluscreen Futura**  
Deep  
Newlifescreen Alu  
Twin Blackout  
Multicolour Dimout

Width	60cm	80cm	100cm	120cm	140cm	160cm	180cm	200cm	Width
Drop cm									Drop cm
60	325.09	353.39	381.53	409.76	438.02	466.27	494.44	522.76	60
80	342.37	376.35	410.34	444.37	478.38	512.33	546.37	580.30	80
100	359.63	399.43	439.21	478.94	518.66	558.39	598.18	637.91	100
120	376.97	422.44	467.94	513.49	558.96	604.45	650.02	695.50	120
140	394.22	445.43	496.74	548.02	599.28	650.58	701.79	753.07	140
160	411.45	468.50	525.59	582.53	639.57	696.60	753.69	810.67	160
180	428.74	491.54	554.36	617.09	679.91	742.69	805.42	868.26	180
200	446.06	514.56	583.11	651.68	720.20	788.71	857.26	925.87	200
220	463.27	537.60	611.96	686.23	760.48	834.82	909.13	983.40	220
240	480.60	560.64	640.75	720.75	800.78	880.85	960.93	1041.03	240
260	497.84	583.66	669.45	755.32	841.11	926.97	1012.76	1098.54	260
280	515.12	606.70	698.29	789.88	881.40	973.01	1064.61	1156.15	280
300	532.36	629.75	727.11	824.42	921.75	1019.15	1116.42	1213.75	300

#### SG 4900 – Hardware only

Supplied ready-assembled incl. adhesive tape for customers to mount own fabrics. Bottom bar not incl. – see back index of our main price list.

Side-guide wire option (with white, grey or black accessories) is available at an additional cost of £78.06.  
For optional stop controller add £20.71.

Spring Clutch	Width of blind up to								Price category C
	60cm	80cm	100cm	120cm	140cm	160cm	180cm	200cm	
4212/3 A/B	234.82	239.12	243.44	247.78	252.07	256.39	260.70	265.00	
4214/5 C/D	271.77	276.28	280.77	285.27	289.70	294.17	298.67	303.19	307.61
4216/7 E/F	279.46	283.88	288.34	292.81	297.19	301.65	306.10	310.57	

Consult Silent Gliss to determine spring type required.

#### Continuous Headrail

Provides an alternative to fitting to the wall or ceiling, supplied made to measure in silver or white £33.49 per m add on. Other custom colours available, pricing as per page 74 of our main price list.

#### SG 4900 – Side-by-Side System

Simply price as two separate systems stating side-by-side.

All prices shown exclude VAT

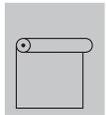

# Roller Blinds

## Laminated Blinds (Customer's own material for Roller Blinds)

Supply your own fabric, we will provide the laminating service. Prices below include for hardware systems 4900/4910. Sewn-in bottom bar supplied as standard (Trim 16). Our laminate will usually be supplied in cream as standard.

Please send a flat sample of customer's own material (1m<sup>2</sup>minimum) so that Silent Gliss can confirm suitability for laminating. All fabrics must be approved prior to ordering.

Price category C

Width cm	System	100	120	140	160	170	180	200	220	230	Width cm
Drop cm											Drop cm
90		433.14	467.24	501.48	535.55	569.66	916.93	931.44	1002.68	1020.35	90
120		481.51	525.27	569.23	613.02	656.75	956.65	991.32	1049.96	1102.30	120
150	4900/	529.94	583.36	637.08	690.45	743.87	1049.30	1104.79	1160.27	1294.55	150
180	4910/	578.33	641.42	704.84	767.89	830.98	1112.33	1243.46	1298.95	1417.47	180
210	(4960 electric)	626.68	699.52	772.57	845.37	918.13	1247.86				210
240		674.99	757.39	840.13	922.55	1004.96	1317.20				240
270		840.55	934.16	1028.20	1121.81	1215.37	1459.03				270
300		888.91	992.22	1098.34	1203.87	1312.43					300

Prices in this table are for spring or chain operation. For standard electric (4960) add £665.98.

### Flame Retardant (FR) Laminate

Add 20% to prices shown above. FR laminate available in white or cream.

### Blackout Laminate

Add 20% to prices shown above. Blackout laminate available in white or cream.

### Decorative Trims

Price on request.

All prices shown exclude VAT

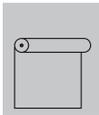

# Roller Blinds

## SG 4907

Chain operated roller blinds.  
Tube diameter 32.2mm

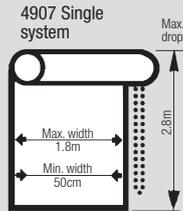

### SG 4907 complete with fabric

The prices below comprise the complete system made-to-measure, ready-to-hang with fabric of your choice. Please consult application chart (page 57) to ensure that fabric desired can be supplied in dimensions required.

Price category C

#### Price Group 1R

Basicscreen 1%  
Basicscreen 5%  
Basicscreen 10%  
Colorama 1  
Colorama 1 Alu  
Colorama 1 Bioactive  
Colorama 1 Eco  
Colorama 1 Multicolour  
Colorama Acoustic  
Colorama Acoustic Multicolour  
Element  
Puma

Width	60cm	80cm	100cm	120cm	140cm	160cm	180cm	Width
Drop cm								Drop cm
60	261.47	276.50	291.53	306.61	321.58	336.68	351.67	60
80	266.66	283.39	300.19	316.90	333.67	350.43	367.22	80
100	271.82	290.32	308.76	327.30	345.73	364.24	382.73	100
120	276.99	297.19	317.39	337.63	357.79	378.07	398.23	120
140	282.15	304.07	326.02	347.97	369.86	391.82	413.74	140
160	287.30	310.97	334.62	358.34	381.96	405.60	429.28	160
180	292.49	317.89	343.30	368.64	394.06	419.44	444.84	180
200	297.74	324.74	351.90	379.01	406.06	433.21	460.32	200
220	302.85	331.72	360.53	389.30	418.14	446.99	475.84	220
240	308.04	338.63	369.13	399.74	430.22	460.82	491.36	240
260	313.18	345.51	377.75	410.06	442.36	474.58	506.89	260
280	318.39	352.37	386.36	420.31	454.43	488.36	522.37	280

#### Price Group 2R

Alutex  
Colorama 2  
Colorama 2 Bioactive  
Colorama 2 Eco  
Colorama 2 Multicolour  
Mercurio  
Multi Visio  
Multishadow  
Multiscreen 1%  
Multiscreen 5%  
Multiscreen 10%  
Newlifescreeen  
Nox

Triscreen 5%  
Versascreen 5%  
Versascreen 10%  
Moon  
Reflex  
Safescreen

Width	60cm	80cm	100cm	120cm	140cm	160cm	180cm	Width
Drop cm								Drop cm
60	271.34	289.65	307.93	326.26	344.60	362.87	381.20	60
80	279.74	300.91	322.05	343.2	364.31	385.39	406.55	80
100	288.22	312.16	336.12	360.04	383.96	407.95	431.92	100
120	296.66	323.46	350.23	377.03	403.78	430.51	457.26	120
140	305.12	334.72	364.31	393.87	423.48	453.08	482.65	140
160	313.60	345.99	378.36	410.78	443.22	475.59	507.95	160
180	322.05	357.19	392.43	427.70	462.97	498.17	533.38	180
200	330.46	368.47	406.55	444.59	482.65	520.66	558.69	200
220	338.92	379.77	420.61	461.48	502.36	543.22	584.06	220
240	347.42	391.02	434.78	478.38	522.08	565.75	609.46	240
260	355.88	402.34	448.83	495.33	541.79	588.28	634.77	260
280	364.31	413.60	462.97	512.20	561.48	610.84	660.12	280

#### Price Group 3R

Aluscreen Futura  
Deep  
Newlifescreeen Alu  
Twin Blackout  
Multicolour Dimout

Width	60cm	80cm	100cm	120cm	140cm	160cm	180cm	Width
Drop cm								Drop cm
60	292.58	318.04	343.37	368.80	394.18	419.65	445.01	60
80	308.14	338.72	369.30	399.94	430.57	461.09	491.74	80
100	323.66	359.49	395.30	431.06	466.78	502.57	538.36	100
120	339.27	380.18	421.15	462.13	503.08	544.02	585.04	120
140	354.81	400.89	447.08	493.23	539.37	585.54	631.62	140
160	370.30	421.65	473.04	524.30	575.61	626.93	678.32	160
180	385.86	442.39	498.92	555.40	611.92	668.40	724.89	180
200	401.43	463.09	524.81	586.50	648.18	709.84	771.53	200
220	416.94	483.87	550.77	617.62	684.43	751.34	818.21	220
240	432.54	504.58	576.65	648.67	720.68	792.77	864.83	240
260	448.05	525.27	602.53	679.80	757.00	834.28	911.45	260
280	463.60	546.04	628.44	710.89	793.25	875.73	958.14	280

#### SG 4907 – Side-by-Side System

There is no add-on. Simply order two systems, stating side-by-side.

#### SG 4907 – Hardware only

Supplied ready-assembled incl. adhesive tape for customers to mount own fabrics.  
Bottom bar not included – see back index of our main pricelist.

#### Width of blind up to

60cm	80cm	100cm	120cm	140cm	160cm	180cm
244.60	248.65	252.68	256.75	260.73	268.82	272.89

#### Continuous Headrail

Provides an alternative to fitting to the wall or ceiling, supplied made to measure in silver or white £33.49 per m add on. Other custom colours available, pricing as per page 74 of our main price list.

All prices shown exclude VAT



# Roller Blinds

## SG 4910

Chain operated roller blinds.  
Tube diameter 41mm



### SG 4910 complete with fabric

The prices below comprise the complete system made-to-measure, ready-to-hang with fabric of your choice. Brackets, bracket covers, bottom bar and bottom bar endcaps supplied as standard in either white, grey or black. Please consult application chart (page 57) to ensure that fabric desired can be supplied in dimensions required. Stainless steel operating chain supplied as standard (brass chain also available at no additional cost). Grey and black accessories available from 1<sup>st</sup> April 2023.

Price category C

#### Price Group 1R

- Basicscreen 1%
- Basicscreen 5%
- Basicscreen 10%
- Colorama 1
- Colorama 1 Alu
- Colorama 1 Bioactive
- Colorama 1 Eco
- Colorama 1 Multicolour
- Colorama Acoustic
- Colorama Acoustic Multicolour
- Element
- Puma

Width	60cm	80cm	100cm	120cm	140cm	160cm	180cm	200cm	220cm	230cm	240cm	Width
Drop cm												Drop cm
60	290.52	307.21	323.91	340.66	357.30	374.10	390.74	407.45	424.16	432.50	440.90	60
80	296.30	314.90	333.55	352.09	370.75	389.38	408.03	426.58	445.22	454.56	463.88	80
100	302.02	322.57	343.09	363.68	384.13	404.69	425.25	445.81	463.97	473.07	482.14	100
120	307.77	330.20	352.66	375.17	397.52	420.08	442.49	464.96	487.40	498.63	509.84	120
140	313.50	337.86	362.23	386.64	410.95	435.34	459.70	484.11	508.46	520.68	532.80	140
160	319.23	345.53	371.81	398.15	424.40	450.65	476.98	503.27	529.61	542.80	555.94	160
180	324.96	353.22	381.44	409.62	437.82	466.04	494.28	522.35	550.55	564.69	578.73	180
200	330.85	360.82	390.98	421.13	451.16	481.36	511.44	541.60	571.70	586.72	601.74	200
220	336.52	368.58	400.61	432.54	464.59	496.66	528.72	560.72	592.82	608.80	624.86	220
240	342.27	376.23	410.14	444.12	478.04	512.01	545.94	579.88	613.79	630.80	647.72	240
260	347.98	383.90	419.74	455.59	491.51	527.30	563.23	599.15	634.95	652.86	670.77	260
280	353.76	391.52	429.30	467.03	504.92	542.66	580.43	618.19	655.95	674.80	693.69	280
300	359.49	399.23	438.85	478.54	518.31	557.98	597.68	637.37	677.06	696.90	716.78	300

#### Price Group 2R

- Alutex
- Atracor
- Colorama 2
- Colorama 2 Bioactive
- Colorama 2 Eco
- Colorama 2 Multicolour
- Mercurio
- Multi Visio
- Multishadow
- Moon
- Multiscreen 1%
- Multiscreen 5%
- Multiscreen 10%
- Newlifescreeen
- Nox
- Triscreen 1%
- Triscreen 3%
- Triscreen 5%
- Versascreen 1%
- Versascreen 2%
- Versascreen 5%
- Versascreen 10%
- Reflex
- Safescreen

Width	60cm	80cm	100cm	120cm	140cm	160cm	180cm	200cm	220cm	230cm	240cm	Width
Drop cm												Drop cm
60	301.50	321.82	342.13	362.51	382.90	403.20	423.58	443.90	464.20	474.38	484.57	60
80	310.82	334.33	357.82	381.32	404.78	428.23	451.71	475.22	498.69	510.47	522.20	80
100	320.27	346.84	373.49	400.03	426.63	453.30	479.92	506.51	533.08	546.40	559.68	100
120	329.63	359.38	389.14	418.92	448.65	478.33	508.07	537.83	567.63	582.50	597.41	120
140	339.03	371.90	404.78	437.65	470.54	503.44	536.29	569.11	602.01	618.47	634.88	140
160	348.46	384.44	420.37	456.45	492.45	528.45	564.41	600.44	636.43	654.39	672.41	160
180	357.82	396.90	436.04	475.22	514.42	553.52	592.62	631.75	670.90	690.48	710.07	180
200	367.19	409.45	451.71	493.98	536.29	578.51	620.78	663.09	705.31	726.46	747.57	200
220	376.59	421.95	467.34	512.78	558.20	603.56	648.94	694.38	739.77	762.49	785.12	220
240	386.01	434.47	483.10	531.56	580.11	628.60	677.17	725.74	774.22	798.51	822.72	240
260	395.41	447.04	498.69	550.34	602.01	653.64	705.30	756.95	808.62	834.45	860.36	260
280	404.78	459.58	514.42	569.11	623.87	678.71	733.49	788.26	843.04	870.41	897.77	280
300	414.20	472.05	530.00	587.92	645.83	703.72	761.66	819.59	877.50	906.48	935.41	300

#### Price Group 3R

- Aluscreen Futura
- Deep
- Jumbotex
- Newlifescreeen Alu
- Twin Blackout
- Multicolour Dimout

Width	60cm	80cm	100cm	120cm	140cm	160cm	180cm	200cm	220cm	230cm	240cm	Width
Drop cm												Drop cm
60	325.09	353.39	381.53	409.76	438.02	466.27	494.44	522.76	550.91	565.05	579.21	60
80	342.37	376.35	410.34	444.37	478.38	512.33	546.37	580.30	614.30	631.30	648.31	80
100	359.63	399.43	439.21	478.94	518.66	558.39	598.18	637.91	677.69	697.78	717.95	100
120	376.97	422.44	467.94	513.49	558.96	604.45	650.02	695.50	740.99	763.77	786.56	120
140	394.22	445.43	496.74	548.02	599.28	650.58	701.79	753.07	804.34	829.99	855.64	140
160	411.45	468.50	525.59	582.53	639.57	696.60	753.69	810.67	867.66	896.20	924.72	160
180	428.74	491.54	554.36	617.09	679.91	742.69	805.42	868.26	931.00	962.33	993.68	180
200	446.06	514.56	583.11	651.68	720.20	788.71	857.26	925.87	994.40	1028.69	1062.95	200
220	463.27	537.60	611.96	686.23	760.48	834.82	909.13	983.40	1057.74	1094.90	1132.06	220
240	480.60	560.64	640.75	720.75	800.78	880.85	960.93	1041.03	1121.11	1161.13	1201.16	240
260	497.84	583.66	669.45	755.32	841.11	926.97	1012.76	1098.54	1184.38	1227.30	1270.19	260
280	515.12	606.70	698.29	789.88	881.40	973.01	1064.61	1156.15	1247.68	1293.45	1339.26	280
300	532.36	629.75	727.11	824.42	921.75	1019.15	1116.42	1213.75	1311.05	1359.69	1408.33	300

#### SG 4910 –

#### Side-by-Side System

There is no add-on. Simply order two systems, stating side-by-side.

Intermediate Cover 10632 required.

#### SG 4910 – Hardware only

Supplied ready-assembled incl. adhesive tape for customers to mount own fabrics. Standard chain drop 1.00m. Bottom bar is not included – see back index of main pricelist.

Side-guide wire option is available (with white, grey or black accessories) at an additional cost of £78.06.

Spring Clutch Set	Width of blind up to											
	60cm	80cm	100cm	120cm	140cm	160cm	180cm	200cm	220cm	240cm		
10545/46/51/52	234.82	239.11	243.43	247.77	252.07	256.39	260.71	265.00	269.29	271.51		
10547/48/53/54	271.78	276.27	280.77	285.28	289.72	294.18	298.68	303.2	307.61	309.83	319.16	
10549/55/10697/98/99/10700	279.46	283.87	288.36	292.81	297.19	301.64	306.11	310.55	314.96	319.41		

Note: To determine the correct spring clutch set please consult Silent Gliss.

Child safety device (10482) – add-on £11.44.

#### Continuous Headrail

Provides an alternative to fitting to the wall or ceiling, supplied made to measure in silver or white £33.49 per m add on. Other custom colours available, pricing as per page 74.

All prices shown exclude VAT

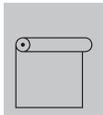

# Roller Blinds

## SG 4930

Heavy duty chain operated Roller Blind system.  
Tube diameter 60mm.

\*Max. surface area 17m<sup>2</sup>  
\*Max. m<sup>2</sup> depends on fabric type.

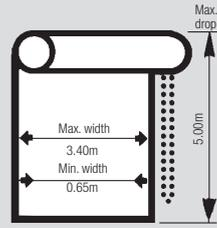

### SG 4930 complete with fabric

The prices below comprise the complete system made-to-measure, ready to hang with fabric of your choice. Brackets, bracket covers, bottom bar and bottom bar endcaps supplied as standard in either white, grey or black. Please be aware that due to the size capabilities of this system, larger sizes can only be achieved by welding the fabric. Fabrics that can be welded are indicated below in bold print. Please consult application chart (page 57) to ensure that fabric desired can be supplied in dimensions required.

Price Category C

#### Price Group 1R

Basicsreen 1%  
Basicsreen 5%  
Basicsreen 10%  
Colorama 1  
Colorama 1 Alu  
Colorama 1 Bioactive  
Colorama 1 Eco  
Colorama 1 Multicolour  
Colorama Acoustic  
Colorama Acoustic Multicolour  
Element  
Puma

Width ► Drop ▼	100cm	125cm	150cm	175cm	200cm	225cm	250cm	275cm	300cm	325cm	340cm	◀ Width ▼ Drop
50cm	397.62	433.35	468.80	505.47	539.92	586.53	612.16	646.62	682.24	717.78	739.12	50cm
100cm	421.15	463.16	504.69	546.28	587.81	629.42	670.95	712.44	754.05	795.63	820.56	100cm
150cm	445.57	493.11	540.61	588.13	635.72	683.25	730.80	778.34	825.86	873.42	889.98	150cm
200cm	469.50	523.00	576.52	630.04	683.57	737.08	790.65	844.17	897.72	951.24	983.34	200cm
250cm	493.42	552.93	612.47	671.97	731.50	790.99	850.51	910.03	969.54	1029.07	1064.77	250cm
300cm	517.39	582.87	648.41	713.89	779.32	844.87	910.35	975.87	1041.40	1106.87	1146.16	300cm
350cm	541.34	612.80	684.31	755.80	827.25	898.75	970.26	1041.68	1113.22	1184.69	1227.55	350cm
400cm	565.29	642.76	720.20	797.67	875.14	952.62	1030.14	1107.59	1185.14	1262.48	1308.95	400cm
450cm	589.22	672.72	756.09	839.55	923.02	1006.50	1090.03	1173.48	1256.85	1340.31	1390.36	450cm
500cm	613.17	702.66	791.99	881.42	970.91	1060.37	1149.92	1239.37	1328.67	1418.11	1471.78	500cm

#### Price Group 2R

Alutex  
Atracor  
Colorama 2  
Colorama 2 Bioactive  
Colorama 2 Eco  
Colorama 2 Multicolour  
Mercurio  
Multi Visio  
Multishadow  
Multiscreen 1%  
Multiscreen 5%  
Multiscreen 10%  
Newlifescreeen  
Nox

Triscreen 1%  
Triscreen 3%  
Triscreen 5%  
Versascreen 1%  
Versascreen 2%  
Versascreen 5%  
Versascreen 10%  
Moon  
Reflex  
Safescreeen

Width ► Drop ▼	100cm	125cm	150cm	175cm	200cm	225cm	250cm	275cm	300cm	325cm	340cm	◀ Width ▼ Drop
50cm	428.11	471.23	514.47	557.7	606.56	644.00	687.18	730.34	773.50	816.71	842.65	50cm
100cm	467.25	520.23	573.18	626.13	679.13	732.11	785.07	838.05	891.04	943.98	975.74	100cm
150cm	506.42	569.17	631.92	694.65	757.44	820.18	882.99	945.73	1008.52	1071.29	1108.94	150cm
200cm	545.58	618.13	690.66	763.20	835.79	908.31	980.89	1053.44	1125.99	1198.51	1242.06	200cm
250cm	584.73	667.08	749.44	831.77	914.09	996.44	1078.77	1161.12	1243.48	1329.46	1381.04	250cm
300cm	623.87	716.05	808.18	900.32	992.48	1084.55	1176.73	1268.89	1360.93	1453.10	1508.42	300cm
350cm	663.09	764.98	866.88	968.83	1070.77	1172.69	1274.61	1376.53	1478.49	1576.77	1635.74	350cm
400cm	702.22	813.96	925.68	1037.36	1149.09	1260.8	1372.50	1484.24	1596.04	1700.43	1763.07	400cm
450cm	741.34	862.94	984.46	1105.88	1227.43	1348.9	1470.38	1591.96	1713.60	1824.10	1890.39	450cm
500cm	780.47	911.91	1043.24	1174.41	1305.75	1437.02	1568.26	1699.53	1831.14	1947.76	2017.72	500cm

#### Price Group 3R

Aluscreen Futura  
Deep  
Jumbotex  
Newlifescreeen Alu  
Twin Blackout  
Multicolour Dimout

Width ► Drop ▼	100cm	125cm	150cm	175cm	200cm	225cm	250cm	275cm	300cm	325cm	340cm	◀ Width ▼ Drop
50cm	493.79	553.40	613.00	672.62	732.23	791.86	851.45	911.09	970.68			50cm
100cm	565.80	643.43	721.05	798.66	876.28	953.87	1031.49	1109.09	1186.72			100cm
150cm	637.83	733.47	829.07	924.69	1020.32	1115.96	1211.57	1307.14	1402.76			150cm
200cm	709.87	823.46	937.06	1050.71	1164.33	1277.97	1391.60	1505.23	1618.86			200cm
250cm	781.88	913.52	1045.13	1176.75	1308.39	1440.02	1571.61	1703.24	1834.88			250cm
300cm	853.85	1003.51	1153.16	1302.81	1452.44	1602.07	1751.69	1901.32	2050.94			300cm
350cm	925.93	1093.56	1261.19	1428.82	1596.46	1764.08	1931.77	2099.39	2267.01			350cm
400cm	997.93	1183.59	1369.22	1554.86	1740.50	1926.13	2111.79	2297.65	2483.08			400cm
450cm	1069.91	1273.62	1477.26	1680.90	1884.54	2088.19	2291.82	2495.90	2699.16			450cm
500cm	1141.91	1363.63	1586.13	1806.95	2028.58	2250.25	2471.84	2694.13	2915.23			500cm

### 4930 – Hardware only

Headrail supplied ready-assembled including adhesive tape for customers to mount own fabric.  
White aluminium bottom bar included as standard.

Width ►	100cm	125cm	150cm	175cm	200cm	225cm	250cm	275cm	300cm	325cm	340cm	◀ Width
	349.76	373.33	396.98	420.56	444.14	467.74	491.36	514.95	538.59	562.14	576.27	

Side-Guiding: Side-guide wires with accessories: Please add £66.33 per system.

### Continuous Headrail

Provides an alternative to fitting to the wall or ceiling, supplied made to measure in grey, black or white £33.49 per m add on. Other custom colours available, pricing as per page 74.

Prices shown exclude VAT

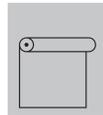

# Roller Blinds

## SG 4930 – Double Connected System

Heavy duty chain operated Roller Blind system.  
Tube diameter 60mm.

\*Max. surface area 30m<sup>2</sup> (15m<sup>2</sup> for each panel of side by side system)

\*Max. m<sup>2</sup> depends on fabric type.

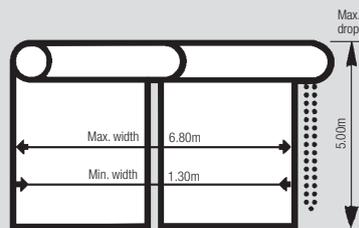

## SG 4930 – Double Connected System complete with fabric

The prices below comprise the complete system made-to-measure, ready to hang with fabric of your choice. Brackets, bracket covers, bottom bar and bottom bar endcaps supplied as standard in either white, grey or black. Please be aware that due to the size capabilities of this system, larger sizes can only be achieved by welding the fabric. Fabrics that can be welded are indicated below in bold print. If a system is required as a double system smaller than widths indicated below, please add £111.07 to single system price. Please consult application chart (page 57) to ensure that fabric desired can be supplied in dimensions required.

Price Category C

### Price Group 1R

- Basicscreen 1%
- Basicscreen 5%
- Basicscreen 10%
- Colorama 1
- Colorama 1 Alu
- Colorama 1 Bioactive
- Colorama 1 Eco
- Colorama 1 Multicolour
- Colorama Acoustic
- Colorama Acoustic Multicolour Element
- Puma**

Width Drop	350cm	375cm	400cm	425cm	450cm	475cm	500cm	525cm	550cm	575cm	600cm	625cm	650cm	680cm	Width Drop
50cm	908.27	943.87	979.41	1014.97	1050.59	1086.16	1121.68	1157.26	1192.86	1228.39	1263.97	1299.55	1335.14	1377.85	50cm
100cm	992.08	1033.64	1075.20	1116.74	1158.34	1199.91	1241.42	1283.02	1324.53	1366.12	1407.68	1449.22	1490.76	1540.63	100cm
150cm	1075.88	1123.41	1170.97	1218.55	1266.10	1313.63	1361.14	1408.70	1456.24	1503.80	1551.28	1598.93	1646.37	1703.31	150cm
200cm	1159.72	1213.22	1266.72	1320.28	1373.81	1427.32	1480.88	1534.40	1587.92	1641.45	1694.99	1748.51	1802.01	1866.16	200cm
250cm	1243.48	1303.01	1362.53	1422.00	1481.54	1541.07	1600.63	1660.13	1719.63	1779.09	1838.69	1898.10	1957.62	2029.03	250cm
300cm	1327.31	1392.82	1458.35	1523.74	1589.28	1654.82	1720.38	1785.84	1851.33	1916.75	1982.38	2047.69	2113.23	2191.89	300cm
350cm	1411.15	1482.62	1554.15	1625.50	1697.01	1768.55	1840.13	1911.54	1983.03	2054.40	2126.06	2197.26	2268.85	2354.75	350cm
400cm	1494.98	1572.45	1649.96	1727.26	1804.76	1882.30	1959.89	2037.27	2114.73	2192.05	2269.77	2346.85	2424.46	2517.58	400cm
450cm	1578.83	1662.26	1745.77	1828.90	1912.48	1996.04	2079.65	2162.97	2246.44	2329.70	2413.46	2496.44	2580.07		450cm
500cm	1662.66	1752.07	1841.58	1930.65	2020.21	2109.77	2199.40	2288.69	2378.12	2467.35	2557.15				500cm

### Price Group 2R

- Alutex
- Atracor
- Colorama 2
- Colorama 2 Bioactive
- Colorama 2 Eco
- Colorama 2 Multicolour
- Mercurio
- Multi Visio
- Multishadow
- Multiscreen 1%
- Multiscreen 5%
- Multiscreen 10%
- Newlifescreen
- Nox

- Triscreen 1%
- Triscreen 3%
- Triscreen 5%
- Versascreen 1%
- Versascreen 2%
- Versascreen 5%
- Versascreen 10%
- Moon
- Reflex
- Safescreen

Width Drop	350cm	375cm	400cm	425cm	450cm	475cm	500cm	525cm	550cm	575cm	600cm	625cm	650cm	680cm	Width Drop
50cm	1014.79	1057.94	1101.18	1144.37	1187.52	1230.70	1273.92	1317.06	1360.26	1403.42	1446.61	1489.79	1532.99	1584.83	50cm
100cm	1151.89	1204.82	1257.81	1310.82	1363.79	1416.73	1469.74	1522.70	1575.65	1628.58	1681.55	1734.57	1787.52	1851.07	100cm
150cm	1288.96	1351.72	1414.46	1477.25	1540.00	1602.70	1665.51	1728.30	1791.01	1853.80	1916.61	1979.32	2042.05	2117.34	150cm
200cm	1426.03	1498.39	1571.10	1643.67	1716.22	1788.81	1861.35	1933.94	2006.50	2079.00	2151.56	2224.06	2296.59	2383.61	200cm
250cm	1563.11	1645.46	1727.79	1810.08	1892.44	1974.83	2057.20	2139.58	2221.98	2304.20	2386.52	2468.82	2551.11	2649.86	250cm
300cm	1700.14	1792.31	1884.47	1976.51	2068.67	2160.85	2253.04	2345.22	2437.47	2529.38	2621.46				300cm
350cm	1837.22	1939.15	2041.16	2142.91	2244.90	2346.88	2449.26	2550.84	2652.96	2754.59	2856.41				350cm
400cm	1974.28	2086.00	2197.85	2309.21	2421.10	2532.90	2644.73	2756.49	2868.46	2979.78	3091.37				400cm
450cm	2111.37	2232.84	2354.53	2475.61	2597.33	2718.94	2840.57	2962.12	3083.94	3204.98	3326.33				450cm
500cm	2248.44	2374.97	2511.20	2642.01	2773.55	2904.97	3038.81	3167.76	3299.42	3430.18	3561.28				500cm

### Price Group 3R

- Aluscreen Futura
- Deep
- Jumbotex
- Newlifescreen Alu
- Twin Blackout
- Multicolour Dimout

Width Drop	350cm	375cm	400cm	425cm	450cm	475cm	500cm	525cm	550cm	575cm	600cm	625cm	650cm	680cm	Width Drop
50cm	1244.79	1304.36	1364.03	1423.65	1483.26	1542.84	1602.46	1662.08	1721.71	1781.26	1840.91				50cm
100cm	1496.86	1574.48	1652.07	1729.71	1807.31	1884.87	1962.54	2040.13	2117.82	2195.37	2273.03				100cm
150cm	1748.90	1844.52	1940.17	2035.77	2131.43	2227.00	2322.62	2418.27	2513.85	2609.50	2705.12				150cm
200cm	2001.00	2114.62	2228.25	2341.89	2455.49	2569.12	2682.74	2796.35	2909.97	3023.62	3137.24				200cm
250cm	2253.07	2384.69	2516.34	2647.94	2779.52	2911.21	3042.88	3174.45	3306.10	3437.73	3569.37				250cm
300cm	2505.13	2654.75	2804.44	2954.00	3103.55	3253.32	3403.01	3552.53	3702.24	3851.83	4001.49				300cm
350cm	2757.17	2924.81	3093.32	3260.11	3427.59	3595.41	3763.13	3930.63	4098.35	4265.95	4433.61				350cm
400cm	3009.22	3194.86	3380.64	3566.08	3751.64	3937.51	4123.27	4308.70	4494.48	4680.05	4865.75				400cm
450cm	3261.28	3464.91	3668.73	3872.21	4075.66	4279.61	4483.40	4686.80	4890.61	5094.17	5297.87				450cm
500cm	3513.33	3734.97	3956.83	4178.33	4399.70	4621.72	4843.52	5064.87	5286.73	5508.26	5730.00				500cm

## SG 4930 Double Connected System – Hardware only

Double headrail system supplied ready-assembled including adhesive tape for customers to mount own fabric. White aluminium bottom bar included as standard.

Width	100cm	150cm	200cm	250cm	300cm	350cm	400cm	450cm	500cm	550cm	600cm	650cm	680cm	Width
	504.66	551.88	599.09	£646.30	£693.44	£740.63	£787.91	£835.06	£882.27	929.42	£976.66	£1023.84	£1052.13	

Side-Guiding: Side-guide wires with accessories: Please add £132.67 per double system.

### Continuous Headrail

Provides an alternative to fitting to the wall or ceiling, supplied made to measure in grey, black or white £33.49 per m add on. Other custom colours available, pricing as per page 74.

Prices shown exclude VAT

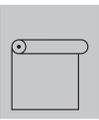

# Roller Blinds

## SG 4840

Heavy duty chain operated  
Roller Blind system.  
Tube diameter 80mm (up to 3.95m width).  
Tube diameter 110mm (over 3.95m width).  
Max. surface area 15m<sup>2</sup>

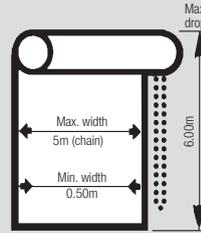

### SG 4840 complete with fabric

The prices below comprise the complete system made-to-measure, ready to hang with fabric of your choice. Please be aware that due to the size capabilities of this system, larger sizes can only be achieved by welding the fabric. Fabrics that can be welded are indicated below in bold print. Please consult application chart (page 57) to ensure that the fabric desired can be supplied in dimensions required.

Price Category C

#### Price Group 1R

**Basicscreen 1%**  
**Basicscreen 5%**  
**Basicscreen 10%**  
Colorama 1  
Colorama 1 Alu  
Colorama 1 Bioactive  
Colorama 1 Eco  
Colorama 1 Multicolour  
Colorama Acoustic  
Colorama Acoustic Multicolour  
Element  
**Puma**

Width Drop ▾	100cm	150cm	200cm	250cm	300cm	350cm	400cm	450cm	500cm	▴ Width Drop
50cm	779.99	868.97	957.98	1046.89	1135.92	1224.85	1376.55	1465.45	1554.45	50cm
100cm	803.01	903.48	1004.04	1104.51	1204.99	1305.44	1468.69	1569.15	1669.66	100cm
150cm	826.05	938.07	1050.07	1162.10	1274.08	1386.12	1498.13	1672.84	1784.81	150cm
200cm	849.07	972.62	1096.17	1219.68	1343.16	1466.67	1653.01	1776.51	1900.04	200cm
250cm	872.20	1007.15	1142.21	1277.30	1412.27	1547.36	1745.10	1880.15	2015.22	250cm
300cm	895.15	1041.67	1188.31	1334.87	1481.40	1627.98	1837.22	1983.76	2130.26	300cm
350cm	918.21	1076.24	1234.37	1392.44	1550.54	1708.59	1929.39			350cm
400cm	941.28	1110.84	1280.44	1450.06	1619.67	1789.25				400cm
450cm	964.29	1145.40	1326.52	1507.63	1688.74					450cm
500cm	987.32	1179.92	1372.51	1565.24	1757.86					500cm
550cm	1010.36	1214.51	1418.63	1622.78						550cm
600cm	1033.42	1249.04	1464.69	1680.37					Max. 15m <sup>2</sup>	600cm

#### Price Group 2R

Alutex  
Atracor  
Colorama 2  
Colorama 2 Bioactive  
Colorama 2 Eco  
Colorama 2 Multicolour  
Mercurio  
Multi Visio  
Multishadow  
**Multiscreen 1%**  
**Multiscreen 5%**  
**Multiscreen 10%**  
Newlifescreen  
Nox

**Triscreen 1%**  
**Triscreen 3%**  
**Triscreen 5%**  
**Versascreen 1%**  
**Versascreen 2%**  
**Versascreen 5%**  
**Versascreen 10%**  
Moon  
Reflex  
Safescreen

Width Drop ▾	100cm	150cm	200cm	250cm	300cm	350cm	400cm	450cm	500cm	▴ Width Drop
50cm	809.23	912.79	1016.42	1120.01	1223.61	1327.26	1493.52	1597.09	1700.70	50cm
100cm	846.84	969.33	1091.73	1214.15	1336.58	1459.01	1644.16	1766.54	1888.99	100cm
150cm	884.56	1025.83	1167.05	1308.28	1449.54	1590.77	1794.77	1936.05	2077.31	150cm
200cm	922.22	1082.28	1242.35	1402.50	1562.55	1722.64	1945.45	2105.51	2265.52	200cm
250cm	959.86	1138.80	1317.70	1496.64	1675.48	1854.39	2096.09	2274.92	2453.83	250cm
300cm	997.54	1195.27	1393.01	1590.71	1788.50	1986.18	2246.67	2444.39	2642.16	300cm
350cm	1035.19	1251.73	1468.28	1684.89	1901.45	2118.01	2397.29			350cm
400cm	1072.83	1308.23	1543.61	1779.04	2014.43	2249.83				400cm
450cm	1110.51	1364.67	1618.96	1873.18	2127.40					450cm
500cm	1148.14	1421.21	1694.30	1967.34	2240.39					500cm
550cm	1185.88	1477.71	1769.56	2061.47						550cm
600cm	1223.49	1534.21	1844.90	2155.59					Max. 15m <sup>2</sup>	600cm

#### Price Group 3R

**Aluscreen Futura**  
Deep  
Jumbotex  
Newlifescreen Alu  
Twin Blackout  
Multicolour Dimout

Width Drop ▾	100cm	150cm	200cm	250cm	300cm	350cm	400cm	450cm	500cm	▴ Width Drop
50cm	872.41	1007.64	1142.87	1278.01	1413.26	1548.41	1746.32	1881.55	2016.71	50cm
100cm	941.64	1111.49	1281.35	1451.16	1620.97	1790.77	2023.38	2193.18	2362.97	100cm
150cm	1010.99	1215.4	1419.83	1624.3	1828.77	2033.27	2300.38	2504.82	2709.33	150cm
200cm	1080.22	1319.27	1558.41	1797.47	2036.53	2275.65	2577.44	2816.53	3055.59	200cm
250cm	1149.49	1423.18	1696.88	1970.64	2244.3	2518.03	2854.5	3128.17	3401.89	250cm
300cm	1218.72	1527.07	1835.42	2143.73	2452.11	2760.46	3131.46	3439.83	3748.24	300cm
350cm	1288	1630.97	1973.9	2316.93	2659.9	3002.84	3408.53			350cm
400cm	1357.22	1734.86	2112.48	2490.05	2867.68	3245.25				400cm
450cm	1426.54	1838.7	2250.95	2663.25	3075.43					450cm
500cm	1495.77	1942.63	2389.47	2836.34	3283.23					500cm
550cm	1565.02	2046.52	2528.04	3009.51						550cm
600cm	1634.26	2150.37	2666.48	3182.7					Max. 15m <sup>2</sup>	600cm

Note: All fabrics are FR

**Side-Guiding of SG 4840** Side-guide wires are available as an option. Please add £227.55 per system (Cat. 'C').

Should crank operation be required please add the following supplement to the system prices above:

Fixed Crank (150cm): £47.89 per System  
Detachable Crank (150cm): £61.51 per system  
To extend crank drop add an additional £1.98 per 10cm  
Note: Crank operation only available on 110mm barrel

Prices shown exclude VAT

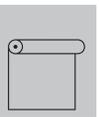

# Roller Blinds

## SG 4955

Battery operated  
Roller Blind system.  
Tube diameter 41mm.

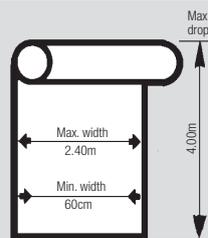

### SG 4955 complete with fabric

The prices below comprise the complete system made-to-measure, ready to hang with fabric of your choice. Please consult application chart (page 57 of our main price list) to ensure that fabric desired can be supplied in dimensions required.

Price Category C

#### Price Group 1R

**Basicscreen 1%**  
**Basicscreen 5%**  
**Basicscreen 10%**  
Colorama 1  
Colorama 1 Alu  
Colorama 1 Bioactive  
Colorama 1 Eco  
Colorama 1 Multicolour  
Colorama Acoustic  
Colorama Acoustic Multicolour  
Element  
**Puma**

Width Drop	60cm	80cm	100cm	120cm	140cm	160cm	180cm	200cm	220cm	240cm	Width Drop
60cm	792.16	806.45	820.74	833.52	846.29	859.07	871.83	886.12	913.57	927.86	60cm
80cm	796.22	811.72	827.21	841.29	855.39	869.49	883.53	899.02	927.86	943.36	80cm
100cm	800.28	816.97	833.66	849.06	864.46	879.91	895.22	911.93	942.17	958.87	100cm
120cm	804.34	822.22	840.13	856.82	873.52	890.33	906.95	924.85	956.47	974.37	120cm
140cm	808.37	827.47	846.57	864.57	882.62	900.65	918.68	937.79	970.75	989.86	140cm
160cm	812.42	832.73	853.04	872.34	891.69	911.08	930.38	950.68	985.05	1005.36	160cm
180cm	816.45	837.97	859.49	880.13	900.81	921.47	942.05	963.56	999.33	1020.85	180cm
200cm	820.52	843.23	865.96	887.91	909.9	931.89	953.75	976.48	1013.61	1036.34	200cm
220cm	824.56	848.50	872.42	895.68	918.98	942.30	965.45	989.38	1027.94	1051.85	220cm
240cm	828.60	853.72	878.84	903.46	928.03	952.60	977.22	1002.35	1042.20	1067.32	240cm
260cm	832.66	858.99	885.32	911.25	937.11	963.01	988.92	1015.25	1056.48	1082.81	260cm
280cm	836.67	864.21	891.75	918.99	946.23	973.39	1000.62	1028.19	1070.77	1098.32	280cm
300cm	840.73	869.47	898.21	926.76	955.31	983.81	1012.35	1041.09	1085.06	1113.82	300cm
320cm	844.77	874.72	904.68	934.54	964.39	994.25	1024.04	1053.99	1099.38	1129.31	320cm
340cm	848.83	879.97	911.14	942.29	973.43	1004.58	1035.70	1066.86	1113.66	1144.81	340cm
360cm	852.89	885.23	917.59	950.06	982.51	1015.01	1047.41	1079.77	1127.96	1160.32	360cm
380cm	856.90	890.46	924.06	957.81	991.55	1025.34	1059.09	1092.66	1142.25	1175.82	380cm
400cm	860.99	895.73	930.50	965.59	1000.65	1035.76	1070.79	1105.58	1156.53	1191.31	400cm

#### Price Group 2R

Alutex  
Atracor  
Colorama 2  
Colorama 2 Bioactive  
Colorama 2 Eco  
Colorama 2 Multicolour  
Mercurio  
Multi Visio  
Multishadow  
Reflex  
**Multiscreen 1%**  
**Multiscreen 5%**  
**Multiscreen 10%**  
Newlifescreen  
Nox

**Triscreen 1%**  
**Triscreen 3%**  
**Triscreen 5%**  
**Versascreen 1%**  
**Versascreen 2%**  
**Versascreen 5%**  
**Versascreen 10%**  
Moon  
Safescreen

Width Drop	60cm	80cm	100cm	120cm	140cm	160cm	180cm	200cm	220cm	240cm	Width Drop
60cm	805.00	823.12	841.23	858.15	875.08	892.02	908.96	927.08	958.92	977.02	60cm
80cm	811.62	831.68	851.75	870.87	889.92	909.05	928.10	948.19	982.27	1002.36	80cm
100cm	818.21	840.27	862.32	883.58	904.77	926.06	947.25	969.29	1005.62	1027.66	100cm
120cm	824.83	848.84	872.86	896.29	919.62	943.05	966.38	990.4	1028.97	1052.98	120cm
140cm	831.49	857.46	883.45	908.93	934.49	959.98	985.52	1011.51	1052.33	1078.30	140cm
160cm	838.08	866.02	893.97	921.65	949.33	976.98	1004.65	1032.6	1075.69	1103.64	160cm
180cm	844.68	874.63	904.54	934.31	964.12	993.92	1023.79	1053.7	1099.04	1128.97	180cm
200cm	851.30	883.19	915.09	947.03	978.99	1010.94	1042.91	1074.80	1122.38	1154.28	200cm
220cm	857.90	891.79	925.63	959.73	993.82	1027.96	1062.05	1095.90	1145.74	1179.60	220cm
240cm	864.56	900.37	936.20	972.39	1008.67	1044.87	1081.15	1117.01	1169.1	1204.89	240cm
260cm	871.17	908.96	946.74	985.09	1023.54	1061.87	1100.29	1138.09	1192.43	1230.23	260cm
280cm	877.70	917.48	957.26	997.84	1038.32	1078.88	1119.44	1159.23	1215.79	1255.57	280cm
300cm	884.35	926.08	967.82	1010.52	1053.16	1095.87	1138.57	1180.32	1239.14	1280.89	300cm
320cm	890.94	934.63	978.34	1023.23	1067.98	1112.87	1157.71	1201.44	1262.5	1306.21	320cm
340cm	897.61	943.28	988.95	1035.97	1082.92	1129.84	1176.82	1222.49	1285.83	1331.51	340cm
360cm	904.21	951.86	999.52	1048.68	1097.75	1146.85	1195.96	1243.59	1309.2	1356.83	360cm
380cm	910.85	960.47	1010.05	1061.37	1112.61	1163.74	1215.07	1264.69	1332.54	1382.16	380cm
400cm	917.46	969.03	1020.62	1074.08	1127.45	1204.01	1234.21	1285.80	1355.89	1407.46	400cm

#### Price Group 3R

**Aluscreen Futura**  
Deep  
Jumbotex  
Newlifescreen Alu  
Twin Blackout  
Multicolour Dimout

Width Drop	60cm	80cm	100cm	120cm	140cm	160cm	180cm	200cm	220cm	240cm	Width Drop
60cm	832.74	859.10	885.48	911.43	937.38	963.30	989.25	1015.62	1056.90	1083.28	60cm
80cm	844.90	874.89	904.90	934.78	964.65	994.55	1024.43	1054.41	1099.85	1129.83	80cm
100cm	857.07	890.70	924.32	958.12	991.95	1025.83	1059.61	1093.24	1142.79	1269.65	100cm
120cm	869.24	906.48	943.71	981.46	1019.22	1057.06	1094.82	1132.05	1185.74	1222.96	120cm
140cm	881.37	922.22	963.07	1004.80	1046.56	1088.29	1129.96	1170.83	1228.68	1269.54	140cm
160cm	893.54	938.02	982.50	1028.14	1073.84	1119.53	1165.16	1209.61	1271.64	1316.11	160cm
180cm	905.67	953.79	1001.89	1051.52	1101.18	1150.76	1200.37	1248.45	1314.57	1362.68	180cm
200cm	917.84	969.57	1021.30	1074.88	1128.45	1182.02	1235.53	1287.27	1357.54	1409.27	200cm
220cm	930.01	985.34	1040.71	1098.23	1155.76	1213.24	1270.74	1326.08	1400.47	1455.83	220cm
240cm	942.17	1001.15	1060.11	1121.56	1183.06	1244.52	1305.89	1364.87	1443.41	1502.38	240cm
260cm	954.35	1016.92	1079.51	1144.92	1210.34	1275.76	1341.10	1403.68	1486.36	1548.97	260cm
280cm	966.51	1032.73	1098.94	1168.30	1237.70	1306.96	1376.33	1442.54	1529.34	1595.55	280cm
300cm	978.70	1048.52	1118.36	1191.64	1264.99	1338.24	1411.51	1481.34	1572.27	1642.12	300cm
320cm	990.87	1064.30	1137.77	1214.99	1292.28	1369.50	1446.69	1520.15	1615.23	1688.69	320cm
340cm	1003.00	1080.11	1157.17	1238.36	1319.51	1400.67	1481.87	1558.96	1658.18	1735.25	340cm
360cm	1015.18	1095.88	1176.59	1261.70	1346.77	1431.93	1517.08	1597.76	1701.13	1781.83	360cm
380cm	1027.38	1111.69	1196.01	1285.07	1374.03	1463.10	1552.26	1636.57	1744.07	1828.38	380cm
400cm	1039.54	1127.47	1215.42	1308.42	1401.32	1494.37	1587.43	1675.37	1787.02	1874.97	400cm

#### SG 4955 Control Options (Category A)

The above system includes the 10949 wall switch.  
The above system is compatible with the below controls at an additional cost.  
10946 Radio hand-held transmitter 1 channel  
10947 Radio hand-held transmitter 2 + 1 channel  
10948 Radio hand-held transmitter 6 + 1 channel  
10950 Radio wall transmitter 2 channel  
10951 Radio wall transmitter 5 + 1 channel  
11429 Timer White

Please see prices on page 28

Prices shown exclude VAT



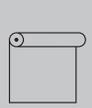

# Roller Blinds

## SG 4970

Heavy duty electrically operated Roller Blind system. Mains voltage. Speed approx. 7cm/sec. Tube diameter 60mm.

\*Max. surface area 17m<sup>2</sup>  
\*Max. m<sup>2</sup> depends on fabric type.

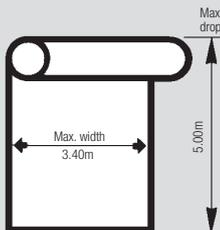

Minimum width dependant on motor type. Refer to catalogue.

## SG 4970 complete with fabric

The prices below comprise the complete system made-to-measure, ready to hang with fabric of your choice. Brackets, bracket covers, bottom bar and bottom bar endcaps supplied as standard in either white, grey or black. Please be aware that due to the size capabilities of this system, larger sizes can only be achieved by welding the fabric. Fabrics that can be welded are indicated below in bold print. Please consult application chart (page 57) to ensure that fabric desired can be supplied in dimensions required.

Price Category C

### Price Group 1R

Basicscreen 1%  
Basicscreen 5%  
Basicscreen 10%  
Colorama 1  
Colorama 1 Alu  
Colorama 1 Bioactive  
Colorama 1 Eco  
Colorama 1 Multicolour  
Colorama Acoustic  
Colorama Acoustic Multicolour  
Element  
Puma

Width Drop	100cm	125cm	150cm	175cm	200cm	225cm	250cm	275cm	300cm	325cm	340cm	Width Drop
50cm	1340.54	1367.90	1395.26	1422.64	1449.98	1477.30	1504.69	1532.06	1559.39	1586.75	1603.17	50cm
100cm	1364.30	1397.54	1430.85	1464.15	1497.43	1530.69	1563.99	1597.26	1630.53	1663.80	1683.76	100cm
150cm	1388.02	1427.23	1466.43	1505.65	1544.85	1584.05	1623.23	1662.46	1701.69	1740.90	1764.42	150cm
200cm	1411.72	1456.83	1501.96	1547.13	1592.28	1637.41	1682.53	1727.66	1772.84	1817.97	1845.06	200cm
250cm	1435.43	1486.52	1537.57	1588.63	1639.71	1690.72	1741.82	1792.92	1843.97	1895.02	1925.65	250cm
300cm	1459.15	1516.12	1573.15	1630.10	1687.11	1744.16	1801.14	1858.12	1915.11	1972.13	2006.33	300cm
350cm	1482.88	1545.77	1608.73	1671.65	1734.58	1797.47	1860.36	1923.35	1986.22	2049.15	2086.92	350cm
400cm	1506.56	1575.44	1644.26	1713.16	1781.99	1850.83	1919.71	1988.55	2057.39	2126.24	2167.54	400cm
450cm	1530.30	1605.03	1679.88	1754.62	1829.43	1904.18	1979.00	2053.77	2128.56	2203.32	2248.19	450cm
500cm	1553.97	1634.69	1715.43	1796.12	1876.83	1957.56	2038.30	2118.93	2200.41	2282.82	2328.82	500cm

### Price Group 2R

Alutex  
Atracor  
Colorama 2  
Colorama 2 Bioactive  
Colorama 2 Eco  
Colorama 2 Multicolour  
Mercurio  
Multi Visio  
Multishadow  
Multiscreen 1%  
Multiscreen 5%  
Multiscreen 10%  
Newlifescreeen

Nox  
Triscreen 1%  
Triscreen 3%  
Triscreen 5%  
Versascreen 1%  
Versascreen 2%  
Versascreen 5%  
Versascreen 10%  
Moon  
Reflex  
Safescreeen

Width Drop	100cm	125cm	150cm	175cm	200cm	225cm	250cm	275cm	300cm	325cm	340cm	Width Drop
50cm	1355.66	1386.73	1417.88	1448.99	1480.14	1511.23	1542.36	1573.46	1604.62	1635.73	1654.38	50cm
100cm	1394.44	1435.26	1476.05	1516.86	1557.74	1598.51	1639.34	1680.12	1720.95	1761.80	1654.38	100cm
150cm	1433.24	1483.74	1534.25	1584.75	1635.27	1685.76	1736.29	1786.83	1837.35	1887.83	1918.13	150cm
200cm	1472.01	1532.24	1592.43	1652.64	1712.84	1773.03	1833.27	1893.46	1953.71	2013.89	2050.01	200cm
250cm	1510.77	1580.70	1650.60	1720.53	1790.44	1860.31	1930.23	2000.11	2070.02	2139.93	2181.87	250cm
300cm	1549.56	1629.19	1708.78	1788.42	1867.97	1947.60	2027.20	2106.82	2186.43	2266.02	2313.76	300cm
350cm	1588.36	1677.62	1766.96	1856.26	1945.99	2034.88	2124.19	2213.46	2302.82	2392.08	2445.66	350cm
400cm	1627.17	1726.14	1825.19	1924.13	2023.16	2122.16	2221.15	2320.14	2419.10	2518.11	2577.52	400cm
450cm	1665.96	1774.61	1883.32	1992.04	2100.72	2209.41	2318.14	2426.80	2535.52	2644.13	2709.30	450cm
500cm	1704.67	1823.15	1941.52	2059.93	2178.29	2296.66	2415.07	2533.51	2651.95	2770.16	2841.07	500cm

### Price Group 3R

Aluscreen Futura  
Deep  
Jumbotex  
Newlifescreeen Alu  
Twin Blackout  
Multicolour Dimout

Width Drop	100cm	125cm	150cm	175cm	200cm	225cm	250cm	275cm	300cm	325cm	340cm	Width Drop
50cm	1388.21	1427.40	1466.65	1505.97	1545.19	1584.47	1623.69	1662.92	1702.26			50cm
100cm	1459.50	1516.60	1573.70	1630.77	1687.88	1744.96	1802.03	1859.11	1916.22			100cm
150cm	1530.86	1605.76	1680.69	1755.58	1830.48	1905.49	1980.37	2055.23	2130.23			150cm
200cm	1602.14	1694.92	1787.65	1880.43	1973.18	2065.89	2158.67	2251.43	2344.17			200cm
250cm	1673.51	1784.09	1894.64	2005.24	2115.84	2226.41	2336.99	2447.60	2558.20			250cm
300cm	1744.81	1873.22	2001.66	2130.07	2258.49	2386.91	2515.32	2643.68	2772.11			300cm
350cm	1816.16	1962.37	2108.64	2254.86	2401.15	2547.38	2693.62	2839.85	2986.12			350cm
400cm	1887.46	2051.53	2215.62	2379.69	2543.82	2707.88	2871.97	3036.04	3200.12			400cm
450cm	1958.82	2140.68	2322.62	2504.52	2686.46	2868.37	3050.26	3232.17	3414.11			450cm
500cm	2030.09	2229.86	2429.65	2629.32	2829.12	3028.80	3228.58	3428.34	3628.10			500cm

#### SG 4970 Control Options

Standard Radio Controlled option – With System 9940, see page 28.

Series 40 motors –With integrated radio receiver for operation with SG wireless system 9940 – add on £233.45 per system, see page 28.

NOTE: 24v Series 40 Motors are not supplied with power supplies (transformers) as standard. They must be ordered separately.

SMART by Silent Gliss motors – for use with Silent Gliss Gateway and associated components – add on £233.45 per system, see page 28.

## SG 4970 – Hardware only

Headrail system supplied ready-assembled including adhesive tape for customers to mount own fabric.  
Bottom bar in white is included as standard.

Width	100cm	125cm	150cm	175cm	200cm	225cm	250cm	275cm	300cm	325cm	340cm	Width
	1316.83	1338.28	1359.67	1381.12	1402.55	1423.94	1445.44	1466.83	1488.25	1509.67	1522.52	

Side-Guiding: Side-guide wires with accessories: Please add £84.19 per system.

## Continuous Headrail

Provides an alternative to fitting to the wall or ceiling, supplied made to measure in grey, black or white £33.49 per m add on. Other custom colours available, pricing as per page 74.

Prices shown exclude VAT





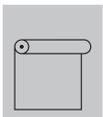

# Roller Blinds

## SG Roller Blind Box / Fascia

Supplied in white or black (Other RAL finishes available - see page 75 of the main price list)

For use on systems 4910, 4960, 4930 and 4970

Optional side channels available for 4960/4970 systems with fascia round, square or box

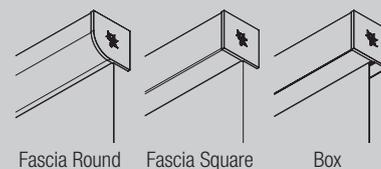

Roller Blind Fascia: Round or Square for systems 4910 / 4960											Small
Width	60cm	80cm	100cm	120cm	140cm	160cm	180cm	200cm	220cm	240cm	Price Cat
£	50.24	57.73	65.22	72.72	80.21	87.71	95.20	102.69	110.19	117.68	C

Roller Blind Fascia: Round or Square for systems 4910 / 4960 / 4930 / 4970															Large	
Width	60cm	80cm	100cm	120cm	140cm	160cm	180cm	200cm	220cm	240cm	260cm	280cm	300cm	320cm	340cm	Price Cat
£	£88.43	101.12	113.81	126.50	139.19	151.88	164.57	177.26	189.95	202.64	215.33	228.02	240.71	253.40	266.09	C

Roller Blind Box: For use with systems 4910 / 4960											Small
Width	60cm	80cm	100cm	120cm	140cm	160cm	180cm	200cm	220cm	240cm	Price Cat
£	£57.07	£66.84	£76.61	£86.39	£96.16	105.93	115.70	125.47	135.25	145.02	C

Roller Blind Box: For use with systems 4910 / 4960 / 4930 / 4970															Large	
Width	60cm	80cm	100cm	120cm	140cm	160cm	180cm	200cm	220cm	240cm	260cm	280cm	300cm	320cm	340cm	Price Cat
£	102.30	119.65	137.01	154.37	171.73	189.08	206.44	223.80	241.15	258.51	275.87	293.22	310.58	327.94	345.29	C

Side channels for systems 4960 / 4970											
Drop	50cm	100cm	150cm	200cm	250cm	300cm	350cm	400cm	450cm	500cm	Price Cat
£	22.56	45.12	67.69	90.25	112.81	135.37	157.93	180.50	203.06	225.62	C

### Additional Notes:

Cannot be used with side guides or with double systems, but multiple blinds with a single fascia cover possible (dependant on system limitations).

When using the small fascia or box fabric drops are restricted, please see technical pages for information.

When using Fascia/Box Small or Large with systems 4910/4960, bottom bar SG11442 is supplied as standard.

When using Fascia/Box Large with systems 4930/4970 the standard bottom bar supplied will be SG10993.

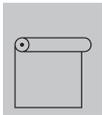

# Roller Blinds

## Max System Height for Fascia/Box Small

(There are no drop restrictions for Fascia/Box Large)

Roller Blind Fabrics Collection 2022		Standard System without Box/Fascia		Standard System with S Box/Fascia	
		Max Height		Max Height	
Fabric	Thickness MM	4910	4960	4910	4960
Atracor	0.54	300	400	260	260
Colorama Acoustic	0.40	300	400	300	360
Colorama Acoustic Multicolor	0.40	300	400	300	360
Colorama 1	0.33	300	400	300	400
Colorama 1 Alu	0.40	300	400	300	360
Colorama 1 Bioactive	0.33	300	400	300	400
Colorama 1 Eco	0.33	300	400	300	400
Colorama 1 Multicolour	0.45	300	400	300	320
Reflex	0.36	300	400	300	400
Aluscreen Futura	0.45	300	400	300	320
Alutex	0.43	300	400	300	330
Colorama 2	0.52	300	400	280	280
Colorama 2 Bioactive	0.55	300	400	260	260
Colorama 2 Eco	0.52	300	400	280	280
Colorama 2 Multicolour	0.55	300	400	260	260
Jumbotex	0.80	280	400	180	180
Multi Visio	0.40	300	400	300	360
Multiscreen 1%	0.55	300	400	260	260
Multiscreen 10%	0.47	300	400	300	310
Multiscreen 5%	0.55	300	400	260	260
Safescreen	0.20	300	400	300	400
Versascreen 1%	0.70	300	400	200	200
Versascreen 2 %	0.63	300	400	220	220
Versascreen 5%	0.55	300	400	260	260
Versascreen 10%	0.55	300	400	260	260
Element	0.30	300	400	300	400
Multi Shadow	0.35	300	400	300	400
Deep	0.45	300	400	300	320
Mercuro	0.38	300	400	300	380
Moon	0.45	300	400	300	320
Multicolour Dimout	0.80	280	400	180	180
Puma	0.38	300	400	300	380
Twin Blackout	0.36	300	400	300	400
Newlifescreeen	0.55	300	400	260	260
Newlifescreeen Alu	0.55	300	400	260	260
Basicscreen 1%	0.65	300	400	220	220
Basicscreen 5%	0.55	300	400	260	260
Basicscreen 10%	0.50	300	400	290	290
Nox	0.44	300	400	300	330
Triscreen 1%	0.64	300	400	220	220
Triscreen 3%	0.63	300	400	220	220
Triscreen 5%	0.61	300	400	220	220

Max. System Height
  Limitations in Height





# Dim-out Roller Blinds

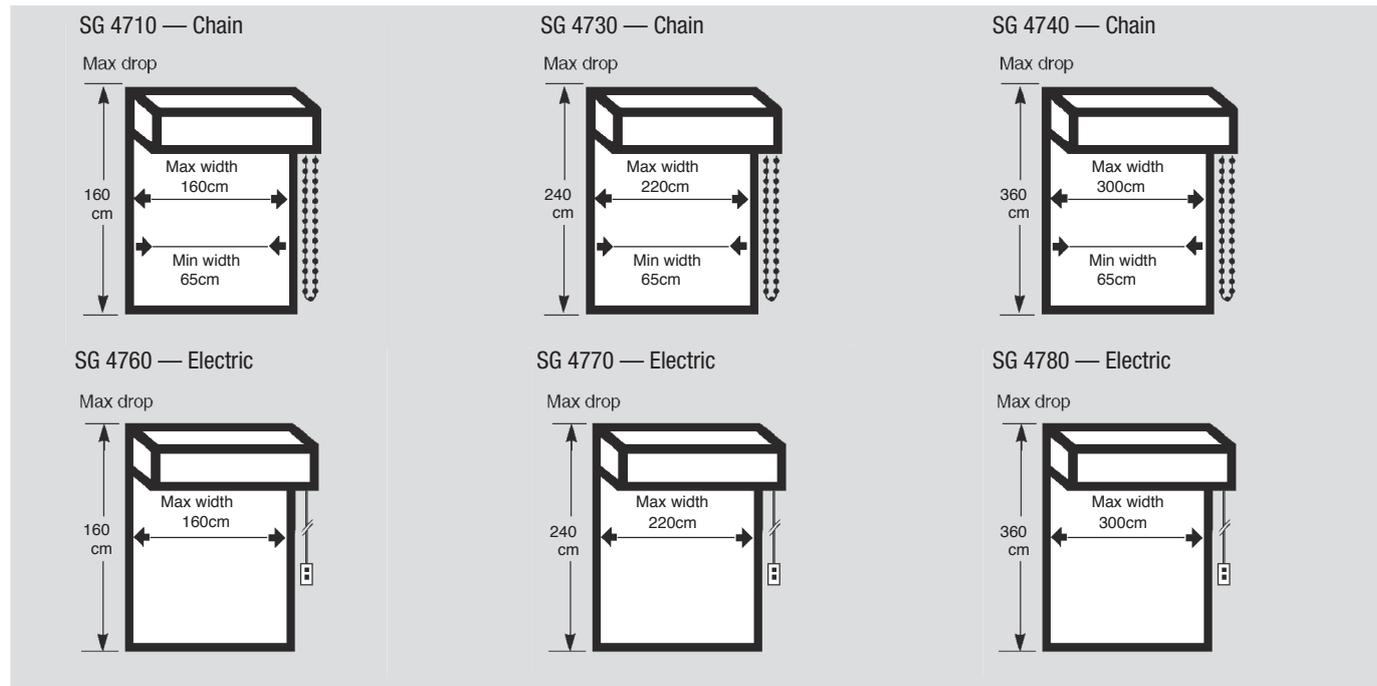

Price category C

The prices in the tables comprise the complete system made-to-measure, with fabric chosen, ready to install.

Colours: White or black available as standard.  
Other colours special orders - consult with Silent Gliss pricing, see page 74 (Accessories available in white or black only)

If sizes lie between the measurements shown, the price for the next larger size will apply.

Note: Laminated customer own fabric not available.  
\*If welded, white not recommended as discolours.

## SG 4710 - Chain (Headbox size: 73mm)

Price Group 1R  
Puma

Width	65cm	80cm	100cm	120cm	140cm	160cm	Width
Drop (cm)							Drop (cm)
60	285.95	306.47	333.77	361.16	388.55	415.87	60
80	310.01	330.55	357.87	385.25	412.64	439.94	80
100	334.10	354.63	381.94	409.33	436.71	464.03	100
120	358.17	378.72	406.02	433.41	460.80	488.12	120
140	382.27	402.79	430.11	457.49	484.88	512.19	140
160	406.35	426.89	454.19	481.59	508.96	536.29	160

Price Group 2R  
Basic Screen 5%  
Mercurio  
Nox

Width	65cm	80cm	100cm	120cm	140cm	160cm	Width
Drop (cm)							Drop (cm)
60	384.55	405.05	432.44	459.76	487.13	514.51	60
80	420.98	441.50	468.84	496.20	523.53	550.91	80
100	457.36	477.89	505.26	532.59	559.98	587.30	100
120	493.80	514.32	541.65	569.03	596.35	623.74	120
140	530.20	550.72	578.10	605.42	632.81	660.12	140
160	566.57	587.08	614.47	641.79	669.17	696.58	160

Price Group 3R  
Moon

Width	65cm	80cm	100cm	120cm	140cm	160cm	Width
Drop (cm)							Drop (cm)
60	452.70	473.24	500.62	528.01	555.33	582.70	60
80	497.67	518.20	545.57	572.90	600.27	627.66	80
100	542.60	563.13	590.52	617.82	645.22	672.52	100
120	587.54	608.06	635.39	662.78	690.14	717.48	120
140	632.50	653.02	680.34	707.73	735.05	762.43	140
160	677.37	697.89	725.29	752.66	779.99	807.36	160

All prices shown exclude VAT



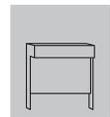

### Dim-Out Roller Blind SG 4760 - Electric (Headbox size: 73mm)

Price category C

#### Price Group 1R - Puma

Width	65cm	80cm	100cm	120cm	140cm	160cm	Width
Drop cm							Drop cm
60	934.86	963.58	1001.84	1040.18	1078.52	1116.76	60
80	968.56	997.29	1035.55	1073.89	1112.22	1150.47	80
100	1002.30	1031.02	1069.25	1107.60	1145.93	1184.18	100
120	1036.01	1064.73	1102.99	1141.32	1179.65	1217.90	120
140	1069.73	1098.45	1136.71	1175.04	1213.37	1251.62	140
160	1103.44	1132.15	1170.41	1208.75	1247.08	1285.33	160

#### Price Group 2R - Basic Screen 5%, Mercurio and Nox

Width	65cm	80cm	100cm	120cm	140cm	160cm	Width
Drop cm							Drop cm
60	1072.89	1101.63	1139.96	1178.21	1216.54	1254.87	60
80	1123.90	1152.62	1190.88	1229.23	1267.47	1305.81	80
100	1174.85	1203.58	1241.92	1280.17	1318.50	1356.76	100
120	1225.86	1254.52	1292.85	1331.20	1369.44	1407.78	120
140	1276.81	1305.55	1343.76	1382.13	1420.46	1458.70	140
160	1327.75	1356.46	1394.81	1433.06	1471.39	1509.73	160

#### Price Group 3R - Moon

Width	65cm	80cm	100cm	120cm	140cm	160cm	Width
Drop cm							Drop cm
60	1168.28	1197.03	1235.37	1273.70	1311.94	1350.27	60
80	1231.21	1259.94	1298.28	1336.52	1374.85	1413.19	80
100	1294.13	1322.85	1361.19	1399.43	1437.76	1476.02	100
120	1357.04	1385.77	1424.00	1462.34	1500.67	1538.92	120
140	1419.95	1448.69	1486.94	1525.27	1563.51	1601.84	140
160	1482.77	1511.50	1549.85	1588.18	1626.43	1664.76	160

System Control Options – Radio control standard option is with System 9940, see page 28.

Series 40 motors –With integrated radio receiver for operation with SG wireless system 9940 – add on £233.45 per system, see page 28.

NOTE: 24v Series 40 Motors are not supplied with power supplies (transformers) as standard. They must be ordered separately, see page 28.

SMART by Silent Gliss motors – for use with Silent Gliss Gateway and associated components – add on £233.45 per system, see page 28.

### Dim-Out Roller Blind SG 4770 - Electric (Headbox size: 90mm)

Price category C

#### Price Group 1R - Puma

Width	65cm	80cm	100cm	120cm	140cm	160cm	180cm	200cm	220cm	Width
Drop cm										Drop cm
60	945.30	976.11	1017.15	1058.22	1099.26	1140.41	1363.63	1404.69	1445.74	60
80	979.01	1009.83	1050.86	1091.93	1132.97	1174.12	1420.10	1461.16	1502.20	80
100	1012.72	1043.53	1084.58	1125.65	1166.71	1207.84	1476.55	1517.61	1558.67	100
120	1046.42	1077.24	1118.29	1159.35	1200.42	1241.56	1533.03	1574.09	1615.23	120
140	1080.14	1110.95	1152.01	1193.07	1234.14	1275.28	1589.48	1630.63	1671.69	140
160	1113.86	1144.67	1185.72	1226.79	1267.84	1308.97	1646.04	1687.10	1728.17	160
180	1147.58	1178.39	1219.43	1260.50	1301.56	1342.69	1702.51	1743.55	1784.62	180
200	1181.29	1212.10	1253.14	1294.21	1335.28	1376.40	1758.96	1800.01	1841.08	200
220	1215.00	1245.82	1286.87	1327.93	1369.00	1410.03	1815.43	1856.48	1897.62	220
240	1248.71	1279.53	1320.58	1361.63	1402.70	1443.76	1871.89	1913.04	1954.08	240

#### Price Group 2R - Basic Screen 5%, Mercurio and Nox

Width	65cm	80cm	100cm	120cm	140cm	160cm	180cm	200cm	220cm	Width
Drop cm										Drop cm
60	1083.32	1114.13	1155.18	1196.34	1237.39	1278.43	1319.51	1416.66	1457.70	60
80	1134.35	1165.16	1206.22	1247.27	1288.30	1329.38	1370.51	1474.57	1515.70	80
100	1185.27	1216.09	1257.14	1298.18	1339.34	1380.40	1421.45	1532.58	1573.62	100
120	1236.29	1267.02	1308.17	1349.22	1390.27	1431.34	1472.39	1590.58	1631.64	120
140	1287.23	1318.05	1359.11	1400.16	1441.22	1482.38	1523.41	1648.49	1689.63	140
160	1338.18	1369.00	1410.03	1451.18	1492.25	1533.28	1574.34	1706.48	1747.55	160
180	1389.18	1420.00	1461.05	1502.13	1543.16	1584.22	1625.37	1764.50	1805.56	180
200	1440.14	1470.95	1512.01	1553.06	1594.21	1635.25	1676.32	1822.42	1863.56	200
220	1491.17	1521.88	1563.03	1604.09	1645.14	1686.17	1727.23	1880.42	1921.46	220
240	1542.09	1572.91	1613.96	1655.01	1696.05	1737.21	1778.26	1938.42	1979.45	240

#### Price Group 3R - Moon

Width	65cm	80cm	100cm	120cm	140cm	160cm	180cm	200cm	220cm	Width
Drop cm										Drop cm
60	1178.79	1209.52	1250.67	1291.73	1332.78	1373.83	1414.90	1456.03	1497.10	60
80	1241.63	1272.46	1313.51	1354.65	1395.71	1436.77	1477.81	1518.87	1560.01	80
100	1304.54	1335.36	1376.40	1417.47	1458.61	1499.68	1540.73	1581.79	1622.83	100
120	1367.45	1398.27	1439.32	1480.39	1521.45	1562.59	1603.64	1644.69	1685.74	120
140	1430.36	1461.19	1502.25	1543.31	1584.36	1625.41	1666.56	1707.62	1748.66	140
160	1493.30	1524.00	1565.15	1606.22	1647.27	1688.33	1729.40	1770.53	1811.58	160
180	1556.12	1586.94	1627.99	1669.14	1710.19	1751.25	1792.31	1833.35	1874.51	180
200	1619.02	1649.84	1690.90	1731.96	1773.09	1814.17	1855.22	1896.28	1937.33	200
220	1681.93	1712.75	1753.81	1794.88	1835.93	1877.08	1918.13	1959.19	2000.23	220
240	1744.86	1775.67	1816.73	1857.79	1898.84	1939.91	1981.04	2022.11	2063.16	240

System Control Options – Radio control standard option is with System 9940, see page 28.

Series 40 motors –With integrated radio receiver for operation with SG wireless system 9940 – add on £233.45 per system, see page 28.

NOTE: 24v Series 40 Motors are not supplied with power supplies (transformers) as standard. They must be ordered separately, see page 28.

SMART by Silent Gliss motors – for use with Silent Gliss Gateway and associated components – add on £233.45 per system, see page 28.

All prices shown exclude VAT



# Dim-Out Roller Blind SG 4780 - Electric (Headbox size: 110mm)

Price category C

## Price Group 1R - Puma

Width	65cm	80cm	100cm	120cm	140cm	160cm	180cm	200cm	220cm	240cm	260cm	280cm	300cm	Width
Drop cm														Drop cm
60	1092.75	1133.08	1186.80	1240.56	1294.39	1348.13	1584.05	1637.80	1691.53	1745.28	1799.11	1852.85	1906.61	60
80	1126.47	1166.80	1220.52	1274.27	1328.10	1381.85	1640.51	1694.25	1747.99	1801.82	1855.58	1909.31	1963.07	80
100	1160.18	1200.49	1254.25	1307.99	1361.81	1415.57	1696.98	1750.72	1804.54	1858.30	1912.04	1965.80	2019.52	100
120	1193.91	1234.21	1287.96	1341.70	1395.52	1449.29	1753.43	1807.27	1861.02	1914.75	1968.49	2022.26	2076.07	120
140	1227.62	1267.93	1321.67	1375.42	1429.25	1482.99	1810.00	1863.72	1917.47	1971.23	2024.96	2078.80	2132.55	140
160	1261.34	1301.65	1355.39	1409.13	1462.96	1516.71	1866.46	1920.19	1973.94	2027.68	2081.51	2135.26	2189.03	160
180	1295.04	1335.36	1389.10	1442.85	1496.58	1550.42	1922.91	1976.66	2030.41	2084.24	2138.00	2191.72	2245.47	180
200	1328.76	1369.07	1422.83	1476.55	1530.30	1584.15	1979.38	2033.12	2086.95	2140.70	2194.45	2248.20	2301.93	200
220	1362.48	1402.78	1456.54	1510.27	1564.01	1617.85	2035.85	2089.68	2143.43	2197.17	2250.91	2304.65	2358.48	220
240	1396.21	1436.51	1490.24	1543.99	1597.73	1651.56	2092.39	2146.14	2199.88	2253.62	2307.38	2361.21	2414.96	240
260	1429.91	1470.22	1523.95	1577.70	1631.44	1685.27	2148.87	2202.61	2256.36	2310.09	2363.93	2417.68	2471.41	260
280	1463.63	1503.94	1557.66	1611.41	1665.16	1718.99	2205.32	2259.06	2312.82	2366.65	2420.39	2474.12	2527.88	280
300	1497.33	1537.65	1591.39	1645.14	1698.87	1752.71	2261.80	2315.53	2369.37	2423.12	2476.85	2530.61	2584.34	300
320	1531.04	1571.35	1625.12	1732.58	1786.43	1840.28	2318.27	2371.99	2425.91	2479.58	2533.30	2587.10	2640.81	320
340	1564.75	1605.06	1658.85	1712.60	1766.29	1820.15	2374.75	2428.46	2536.05	2536.05	2589.76	2643.59	2697.28	340
360	1598.46	1638.77	1692.58	1746.33	1800.00	1853.87	2431.23	2485.00	2592.59	2592.52	2646.22	2700.07	2753.74	360

## Price Group 2R - Basic Screen 5% (up to 300cm), Mercurio and Nox (up to 260cm)

Width	65cm	80cm	100cm	120cm	140cm	160cm	180cm	200cm	220cm	240cm	260cm	280cm	300cm	Width
Drop cm														Drop cm
60	1291.58	1335.36	1393.72	1452.09	1510.53	1568.92	1627.27	1685.65	1860.75	1919.10	1977.47	2035.92	2094.30	60
80	1329.11	1372.87	1431.24	1489.69	1548.06	1606.43	1664.79	1723.17	1912.85	1971.23	2029.68	2088.05	2146.40	80
100	1366.64	1410.50	1468.86	1527.23	1585.58	1643.96	1702.4	1760.78	1964.96	2023.43	2081.8	2140.16	2198.51	100
120	1404.22	1448.02	1506.38	1564.75	1623.10	1681.57	1739.93	1798.29	2017.18	2075.53	2133.91	2192.27	2250.65	120
140	1441.76	1485.54	1543.90	1602.26	1660.72	1719.09	1777.45	1835.81	2069.28	2127.65	2186.02	2244.37	2302.85	140
160	1479.27	1523.07	1581.42	1639.87	1698.25	1756.62	1814.97	1873.35	2121.39	2179.76	2238.13	2296.59	2354.94	160
180	1516.80	1560.57	1619.02	1677.39	1735.77	1794.13	1852.50	1910.96	2173.52	2231.87	2290.33	2348.71	2407.07	180
200	1554.42	1598.18	1656.54	1714.91	1773.27	1831.66	1890.10	1948.49	2225.63	2284.08	2342.45	2400.82	2459.19	200
220	1591.93	1635.72	1694.07	1752.46	1810.89	1869.27	1927.63	1986.01	2277.83	2336.19	2394.56	2452.94	2511.29	220
240	1629.45	1673.23	1731.59	1790.05	1848.42	1906.78	1965.16	2023.51	2329.94	2388.31	2446.68	2505.05	2563.50	240
260	1666.98	1710.76	1769.19	1827.58	1885.93	1944.31	2002.67	2061.14	2382.04	2440.41	2498.79	2557.24	2615.62	260
280	1704.49	1748.35	1806.74	1865.10	1923.47	1981.82	2040.29	2098.65	2434.16	2492.53	2550.99	2609.35	2667.70	280
300	1742.11	1785.88	1844.25	1902.63	1960.98	2019.45	2077.80	2136.18	2486.27	2544.73	2603.10	2661.46	2719.84	300
320	1779.73	1823.40	1881.77	1940.15	1998.49	2057.08	2115.31	2173.70	2538.38	2596.94	2655.20	2713.57	2771.98	320
340	1817.35	1860.93	1919.28	1977.67	2036.01	2094.71	2152.83	2211.22	2590.49	2649.14	2707.31	2765.68	2824.13	340
360	1854.97	1898.45	1956.79	2015.20	2073.52	2132.34	2190.34	2248.75	2642.60	2701.35	2759.42	2817.79	2876.27	360

## Price Group 3R - Moon

Width	65cm	80cm	100cm	120cm	140cm	160cm	180cm	200cm	220cm	240cm	260cm	280cm	300cm	Width
Drop cm														Drop cm
60	1326.20	1366.61	1420.33	1474.08	1527.82	1581.56	1635.40	1689.15	1742.88	1765.58				60
80	1389.10	1429.42	1483.26	1537.00	1590.73	1644.49	1698.23	1752.07	1805.79	1828.48				80
100	1452.03	1492.33	1546.07	1599.91	1653.65	1707.41	1761.13	1814.89	1868.74	1891.47				100
120	1514.93	1555.23	1609.00	1662.73	1716.56	1770.31	1824.06	1877.80	1931.53	1954.36				120
140	1577.85	1618.15	1671.92	1725.64	1779.40	1833.24	1886.98	1940.71	1994.45	2017.25				140
160	1640.68	1681.09	1734.82	1788.56	1842.31	1896.04	1949.88	2003.64	2057.36	2080.15				160
180	1703.59	1743.91	1797.74	1851.49	1905.22	1958.98	2012.72	2066.57	2120.29	2143.06				180
200	1766.52	1806.82	1860.57	1914.39	1968.14	2021.89	2075.63	2129.37	2183.22	2205.96				200
220	1829.42	1869.72	1923.48	1977.22	2031.06	2084.79	2138.55	2192.28	2246.02	2268.86				220
240	1892.34	1932.66	1986.40	2040.15	2093.88	2147.72	2201.47	2255.20	2308.96	2331.75				240
260	1955.18	1995.58	2049.30	2103.06	2156.79	2210.53	2264.37	2318.11	2371.87	2394.66				260
280	2018.08	2058.39	2112.23	2165.98	2219.71	2273.47	2327.21	2381.05	2434.79	2457.55				280
300	2081.00	2121.30	2175.07	2228.88	2282.64	2336.38	2390.11	2443.86	2497.70	2520.45				300
320	2143.92	2184.21	2237.90	2291.78	2345.56	2399.29	2453.01	2506.68	2560.61	2583.35				320
340	2206.85	2247.13	2300.74	2354.68	2408.48	2462.28	2515.91	2569.49	2623.52	2646.25				340
360	2269.77	2310.04	2363.58	2417.58	2471.40	2525.11	2578.81	2632.31	2686.43	2709.15				360

System Control Options – Radio control standard option is with System 9940, see page 28.

Series 40 motors – With integrated radio receiver for operation with SG wireless system 9940 – add on £233.45 per system, see page 28.

NOTE: 24v Series 40 Motors are not supplied with power supplies (transformers) as standard. They must be ordered separately, see page 28.

SMART by Silent Gliss motors – for use with Silent Gliss Gateway and associated components – add on £233.45 per system, see page 28.

All prices shown exclude VAT



# Venetian Blinds

## Venetian Blind Slat Information

### Aluminium Slats

#### Price Group 1

Slat Reference	Slat Width (mm)	Slat Description
603	16	Natural Alu
612	16	Off White
613	16	Clear White
615	16	White

Slat Reference	Slat Width (mm)	Slat Description
648	16	Light Grey
650	16	Magnolia
706	25	Natural Alu
716	25	Off White

Slat Reference	Slat Width (mm)	Slat Description
718	25	Clear White
720	25	White
758	25	Light Grey
759	25	Light Grey

Slat Reference	Slat Width (mm)	Slat Description
761	25	Magnolia

#### Price Group 2

Slat Reference	Slat Width (mm)	Slat Description
601	16	Polished Alu
602	16	TRP Natural Silver
604	16	Bright Silver
606	16	Caribou
609	16	Natural Silver
610	16	Natural Silver Matt
611	16	Light Ash
614	16	Pearl China White
616	16	Light Grey
617	16	Grey Flannel

Slat Reference	Slat Width (mm)	Slat Description
618	16	Metal Grey
619	16	Gloss Black
620	16	Black
624	16	Turkey Blue
651	16	Magnolia
703	25	Polished Alu
704	25	TRP Natural Silver
705	25	Alu Perforated
707	25	Bright Silver
712	25	Natural Silver

Slat Reference	Slat Width (mm)	Slat Description
713	25	Natural Silver Matt
714	25	Light Ash
715	25	White Perforated
719	25	Pearl China White
723	25	Light Grey
724	25	Grey Flannel
725	25	Metal Grey
726	25	Gloss Black
729	25	Black
733	25	Turkey Blue

Slat Reference	Slat Width (mm)	Slat Description
762	25	Magnolia Perforated
762	25	Magnolia
771	25	Glossy Red
773	25	Garnet Red

#### Price Group 3

Slat Reference	Slat Width (mm)	Slat Description
605	16	Bright Gold
607	16	Bright Bronze
608	16	Aluminium Gris
622	16	Indigo
625	16	Mount Baker
626	16	Morning Glory
627	16	Universe Blue
635	16	Hunter Green
646	16	Light Banana
652	16	Fawn
654	16	US Beige
656	16	Dark Beige
702	25	Alu Perforated
708	25	Bright Gold
709	25	Caribou
710	25	Bright Bronze
711	25	Aluminium Gris
722	25	Grey Perforated
727	25	Black Perforated
728	25	Black
731	25	Indigo
732	25	Admiral

Slat Reference	Slat Width (mm)	Slat Description
734	25	Mount Baker
735	25	Morning Glory
736	25	Universe Blue
738	25	Fishing Blue
739	25	Greek Holiday
740	25	Light Laguna
745	25	Hunter Green
747	25	Green Aspen
748	25	Weeping Green
749	25	Grass Snake
751	25	Aztec
752	25	Saffron
754	25	Daffodil
756	25	Light Banana
757	25	Beaverwood
764	25	Fawn
765	25	Spun Gold
766	25	US Beige
767	25	Mud Pie
768	25	Dark Beige
769	25	Diamond Mine
777	25	Woodgrain Abbey



# Venetian Blinds

## SG 8110 (16mm)

Mono control Venetian Blind System.  
 Slats 16mm.  
 Maximum System Width: 2.5m  
 Minimum System Width: 28cm  
 Maximum System Drop: 2.5m  
 Maximum Surface Area: 5m<sup>2</sup>

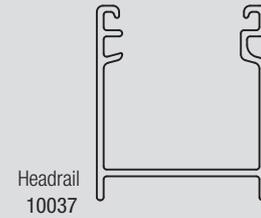
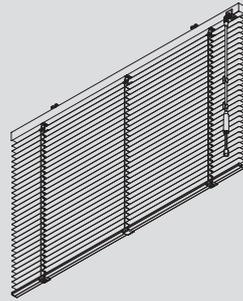

The prices in the tables below comprise the complete system made-to-measure with 16mm slats ready to hang. If sizes lie between the measurements shown, the price for the next size larger will apply. Clear control wands as standard. The following wand sizes are available 225mm, 385mm, 585mm, 785mm, 985mm, 1185mm, 1385mm, 1585mm and 1800mm. For side guided version please add 20% to prices below.

### Price Group 1

Price Category C

Width Drop cm	60cm	80cm	100cm	120cm	140cm	160cm	180cm	200cm	220cm	240cm	250cm	Width Drop cm
60	187.17	204.56	221.95	239.36	256.77	274.18	291.57	308.98	326.37	343.82	352.48	60
80	192.76	211.98	231.19	250.38	269.62	288.82	308.03	327.23	346.42	365.66	375.24	80
100	198.36	219.37	240.38	261.44	282.43	303.43	324.43	345.48	366.48	387.49	398.01	100
120	203.95	226.78	249.59	272.43	295.24	318.08	340.91	363.72	386.53	409.35	420.79	120
140	209.54	234.16	258.79	283.39	308.06	332.69	357.32	381.96	406.57	431.23	443.55	140
160	215.13	241.55	268.01	294.43	320.87	347.31	373.76	400.22	426.65	453.08	466.32	160
180	220.71	248.98	277.22	305.44	333.69	361.96	390.19	418.44	446.69	474.94	489.06	180
200	226.28	256.36	286.41	316.47	346.54	376.59	406.64	436.67	466.76	496.81	511.83	200
220	231.90	263.76	295.60	327.50	359.33	391.21	423.09	454.93	486.81			220
240	237.48	271.15	304.85	338.46	372.18	405.82	439.49	473.16				240
260	240.29	274.85	309.42	343.98	378.58	413.16	447.71	482.30				260

### Price Group 2

Price Category C

Width Drop cm	60cm	80cm	100cm	120cm	140cm	160cm	180cm	200cm	220cm	240cm	250cm	Width Drop cm
60	193.32	212.77	237.12	251.70	271.14	290.60	310.03	329.49	348.95	368.40	378.13	60
80	200.98	222.92	244.86	266.78	288.77	310.71	332.63	354.58	376.53	398.48	409.46	80
100	208.62	233.04	257.48	281.92	306.35	330.82	355.21	379.66	404.09	428.54	440.74	100
120	216.24	243.15	270.13	297.02	323.94	350.91	377.82	404.73	431.67	458.60	472.05	120
140	223.89	253.31	282.76	312.13	341.56	370.99	400.39	429.81	459.22	488.65	503.37	140
160	231.51	263.44	295.36	327.25	359.17	391.07	423.00	454.91	486.83	518.73	534.66	160
180	239.19	273.60	307.98	342.36	376.77	411.18	445.59	479.98	514.38	548.78	566.00	180
200	246.80	283.72	320.60	357.50	394.39	431.28	468.17	505.08	541.97	578.84	597.33	200
220	254.47	293.84	333.23	372.64	411.98	451.38	490.78	530.15	569.54			220
240	262.09	303.98	345.84	387.73	429.61	471.46	513.36	555.20				240
260	265.90	309.02	352.15	395.30	438.42	481.53	524.65	567.77				260

### Price Group 3

Price Category C

Width Drop cm	60cm	80cm	100cm	120cm	140cm	160cm	180cm	200cm	220cm	240cm	250cm	Width Drop cm
60	207.99	229.67	251.30	272.97	294.62	316.26	337.90	359.56	381.20	402.87	413.71	60
80	217.15	241.78	266.39	291.04	315.67	340.32	364.92	389.56	414.21	438.84	451.14	80
100	226.25	253.90	281.49	309.13	336.73	364.35	391.97	419.58	447.20	474.82	488.62	100
120	235.38	266.00	296.58	327.21	357.81	388.39	419.00	449.61	480.21	510.81	526.11	120
140	244.54	278.13	311.68	345.25	378.87	412.46	446.06	479.63	513.22	546.79	563.57	140
160	253.64	290.24	326.78	363.36	399.94	436.50	473.09	509.63	546.20	582.78	601.05	160
180	262.75	302.34	341.87	381.44	420.97	460.53	500.08	539.65	579.19	618.78	638.55	180
200	271.90	314.45	357.00	399.51	442.07	484.57	527.16	569.67	612.19	654.76	676.02	200
220	281.04	326.56	372.06	417.61	463.14	508.63	554.16	599.70	645.22			220
240	278.74	338.70	387.19	435.70	484.20	532.69	581.18	629.70				240
260	294.73	344.72	394.72	444.70	494.73	544.70	594.70	644.68				260

All prices shown exclude VAT



# Venetian Blinds

## SG 8110PC (25mm)

Mono control Venetian Blind System.  
Slats 25mm.  
Maximum System Width: 3m  
Minimum System Width: 28cm  
Maximum System Drop: 5m  
Maximum Surface Area: 7m<sup>2</sup>

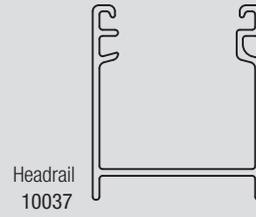
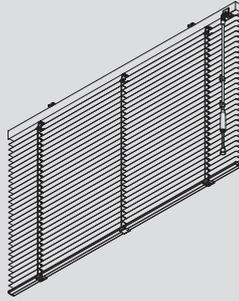

The prices in the tables below comprise the complete system made-to-measure with 25mm slats ready to hang. If sizes lie between the measurements shown, the price for the next size larger will apply. Clear control wands as standard. The following wand sizes are available 225mm, 385mm, 585mm, 785mm, 985mm, 1185mm, 1385mm, 1585mm and 1800mm. For side guided version please add 20% to prices below.

### Price Group 1

### Price Category C

Width ► Drop ▼ cm	60cm	80cm	100cm	120cm	140cm	160cm	180cm	200cm	220cm	240cm	260cm	280cm	300cm	Width Drop cm
60	189.78	207.94	226.11	244.25	262.40	280.56	298.73	316.90	335.03	353.20	371.37	389.53	407.68	60
80	195.64	215.63	235.63	255.62	275.61	295.61	315.62	335.59	355.61	375.60	395.62	415.65	435.62	80
100	201.47	223.31	245.16	267.00	288.84	310.71	332.51	354.34	376.18	398.02	419.83	441.71	463.56	100
120	207.34	230.98	254.69	278.37	302.07	325.71	349.42	373.10	396.75	420.42	444.10	467.80	491.50	120
140	213.17	238.71	264.22	289.75	315.29	340.76	366.29	391.82	417.33	442.86	468.38	493.92	519.41	140
160	219.05	246.39	273.75	301.10	328.47	355.83	383.17	410.56	437.92	465.27	492.61	519.96	547.36	160
180	224.91	254.08	283.29	312.50	341.68	370.85	400.09	429.27	458.49	487.71	516.87	546.08	575.27	180
200	230.75	261.78	292.81	323.86	354.91	385.92	416.97	448.02	479.05	510.09	541.13	572.19	603.20	200
220	236.59	269.46	302.35	335.25	368.11	401.00	433.86	466.76	499.62	532.50	565.37	598.22	631.12	220
240	242.44	277.16	311.89	346.61	381.32	416.03	450.77	485.48	520.20	554.94	589.64	624.34	659.07	240
260	248.28	284.86	321.40	357.99	394.55	431.07	467.67	504.22	540.77	577.33	613.85	650.45		260
280	254.14	292.56	330.93	369.38	407.76	446.12	484.53	522.91	561.37	599.73	638.12			280
300	260.00	300.22	340.47	380.70	420.94	461.21	501.46	541.66	581.91	622.16				300
320	265.86	307.96	350.02	392.08	434.18	476.26	518.33	560.37	602.50					320
340	271.72	315.62	359.56	403.48	447.38	491.29	535.19	579.15						340
360	277.59	323.32	369.07	414.83	460.59	506.35	552.11	597.87						360
380	283.39	331.00	378.62	426.22	473.81	521.40	569.00							380
400	289.27	338.72	388.12	437.58	487.00	536.44	585.88							400
420	295.11	346.39	397.67	448.97	500.22	551.50								420
440	300.98	354.07	407.22	460.34	513.44	566.56								440
460	306.81	361.78	416.74	471.71	526.65									460
480	312.70	369.49	426.28	483.08	539.86									480
500	318.57	377.18	435.81	494.44	553.09									500

### Price Group 2

### Price Category C

Width ► Drop ▼ cm	60cm	80cm	100cm	120cm	140cm	160cm	180cm	200cm	220cm	240cm	260cm	280cm	300cm	Width Drop cm
60	196.10	216.37	236.69	256.93	277.22	297.50	317.76	338.01	358.31	378.58	398.84	419.13	439.38	60
80	204.07	226.89	249.71	272.55	295.36	318.18	341.00	363.81	386.62	409.46	432.27	455.07	477.92	80
100	212.04	237.43	262.75	288.13	313.51	338.85	364.23	389.56	414.91	440.30	465.66	491.01	516.38	100
120	220.01	247.92	275.81	303.73	331.66	359.56	387.44	415.36	443.27	471.18	499.09	526.99	554.91	120
140	227.98	258.45	288.87	319.31	349.80	380.22	410.67	441.12	471.57	502.03	532.47	562.94	593.40	140
160	235.93	268.94	301.97	334.92	367.93	400.93	433.93	466.90	499.92	532.93	565.89	598.90	631.89	160
180	243.90	279.44	314.98	350.53	386.05	421.63	457.14	492.70	528.25	563.78	599.29	634.84	670.40	180
200	251.89	289.95	328.07	366.16	404.21	442.31	480.40	518.48	556.56	594.65	632.75	670.81	708.90	200
220	259.85	300.48	341.11	381.74	422.35	462.99	503.63	544.26	584.89	625.52	666.11	706.74	747.38	220
240	267.83	310.98	354.17	397.36	440.49	483.70	526.86	570.04	613.19	656.41	699.56	742.73	785.91	240
260	275.78	321.52	367.22	412.95	458.64	504.38	550.07	595.82	641.51	687.24	732.96	778.67		260
280	283.76	332.00	380.28	428.55	476.79	525.08	573.34	621.61	669.86	718.09	766.37			280
300	291.72	342.51	393.33	444.12	494.91	545.74	596.55	647.35	698.17	748.97				300
320	299.69	353.03	406.39	459.76	513.07	566.40	619.79	673.15	726.46					320
340	307.62	363.54	419.44	475.34	531.22	587.09	643.01	698.91						340
360	315.60	374.06	432.49	490.92	549.39	607.78	666.24	724.68						360
380	323.59	384.56	445.57	506.54	567.52	628.52	689.50							380
400	331.53	395.08	458.60	522.10	585.68	649.19	712.69							400
420	339.52	405.58	471.69	537.75	603.81	669.89								420
440	347.48	416.10	484.71	553.31	621.97	690.57								440
460	355.47	426.62	497.77	568.94	640.08									460
480	363.40	437.10	510.82	584.53	658.22									480
500	371.38	447.64	523.88	600.14	676.40									500

All prices shown exclude VAT



## Venetian Blinds

### SG 8110PC (25mm)

Mono control Venetian Blind System.  
 Slats 25mm.  
 Maximum System Width: 3m  
 Minimum System Width: 28cm  
 Maximum System Drop: 5m  
 Maximum Surface Area: 7m<sup>2</sup>

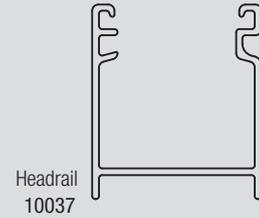
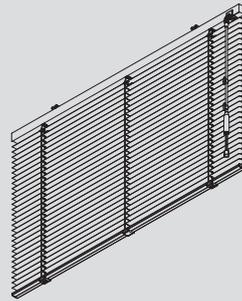

The prices in the table below comprise the complete system made-to-measure with 25mm slats ready to hang. If sizes lie between the measurements shown, the price for the next size larger will apply. Clear control wands as standard. The following wand sizes are available 225mm, 385mm, 585mm, 785mm, 985mm, 1185mm, 1385mm, 1585mm and 1800mm. For side guided version please add 20% to prices below.

Price Group 3 – 25mm slat size

Price Category C

Width Drop cm	60cm	80cm	100cm	120cm	140cm	160cm	180cm	200cm	220cm	240cm	260cm	280cm	300cm	Width Drop cm
60	214.20	240.47	266.76	293.08	319.37	345.66	371.95	398.27	424.60	450.87	477.17	503.47	529.77	60
80	228.18	259.02	289.87	320.72	351.56	382.43	413.26	444.12	474.96	505.80	536.69	567.53	598.40	80
100	242.17	277.59	312.99	348.37	383.80	419.19	454.59	489.97	525.39	560.79	596.20	631.60	666.99	100
120	256.15	296.11	336.06	376.01	415.98	455.95	495.89	535.85	575.82	615.78	655.69	695.69	735.64	120
140	270.16	314.67	359.17	403.68	448.17	492.70	537.22	581.73	626.24	670.72	715.24	759.71	804.24	140
160	284.13	333.22	382.27	431.34	480.40	529.46	578.50	627.57	676.62	725.69	774.76	823.80	872.87	160
180	298.14	351.74	405.39	458.97	512.59	566.21	619.82	673.42	727.03	780.64	834.27	887.89	941.49	180
200	312.10	370.29	428.46	486.60	544.79	602.97	661.12	719.32	777.43	835.61	893.80	951.92	1010.12	200
220	326.10	388.84	451.56	514.27	577.01	639.74	702.41	765.14	827.86	890.59	953.28	1016.02	1078.74	220
240	340.08	407.38	474.68	541.93	609.19	676.45	743.73	811.02	878.27	945.53	1012.80	1080.12	1147.34	240
260	354.07	425.92	497.72	569.59	641.40	713.19	785.04	856.85	928.68	1000.51	1072.33	1144.16		260
280	368.10	444.45	520.83	597.23	673.59	749.97	826.33	902.70	979.10	1055.47	1131.86			280
300	382.11	463.00	543.94	624.86	705.89	786.70	867.65	948.57	1029.50	1110.46				300
320	396.09	481.56	567.05	652.53	737.99	823.46	908.97	994.44	1079.90					320
340	410.08	500.08	590.11	680.17	770.20	860.22	950.25	1040.28						340
360	424.07	518.66	613.22	707.80	802.42	896.98	991.57	1086.17						360
380	438.06	537.20	636.32	735.47	834.59	933.74	1032.86							380
400	452.05	555.74	659.42	763.13	866.79	970.48	1074.18							400
420	466.03	574.27	682.51	790.78	899.00	1007.25								420
440	480.00	592.83	705.60	818.37	931.22	1043.98								440
460	494.00	611.37	728.71	846.06	963.38									460
480	507.99	629.94	751.79	873.71	995.59									480
500	522.00	648.44	774.89	901.37	1027.83									500

All prices shown exclude VAT

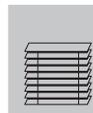

# Venetian Blinds

## SG 8250 (16mm)

Electrically operated Venetian Blind System.  
System with 24v motor 8060.

Maximum System Width: 300cm  
Minimum System Width: 65cm\*  
Maximum System Drop: 340cm  
Maximum Surface Area: 5m<sup>2</sup>

\* Please refer to Catalogue pages

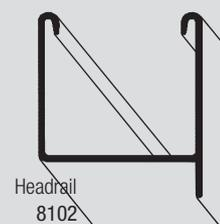
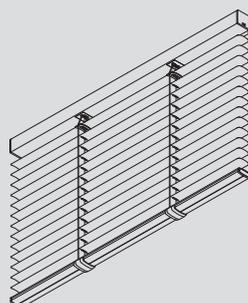

The prices in the tables below and on the following page comprise the complete system made-to-measure with 16mm slats ready to hang with universal snap bracket 8201. If sizes lie between the measurements shown, the price for the next size larger will apply. For multicoloured blinds add 20% to prices below for each colour. For side-guided/sloping version add 20% to prices below.

### Price Group 1

### Price Category C

Width Drop cm	80cm	100cm	120cm	140cm	160cm	180cm	200cm	220cm	240cm	260cm	280cm	300cm	Width Drop cm
60	754.70	790.87	827.01	863.16	899.38	935.50	971.65	1007.83	1043.98	1080.16	1116.30	1152.47	60
80	763.22	801.28	839.26	877.30	915.34	953.31	991.33	1029.37	1067.36	1105.41	1143.41	1181.42	80
100	771.78	811.65	851.49	891.41	931.25	971.14	1011.07	1050.87	1090.77	1130.63	1170.49	1210.39	100
120	780.29	821.99	863.73	905.49	947.22	988.96	1030.69	1072.37	1114.16	1155.85	1197.59	1239.34	120
140	788.82	832.35	876.01	919.56	963.16	1006.72	1050.32	1093.96	1137.54	1181.09	1224.70	1268.28	140
160	797.37	842.82	888.20	933.69	979.15	1024.60	1070.00	1115.46	1160.90	1206.36	1251.80	1297.23	160
180	805.85	853.19	900.47	947.80	995.10	1042.37	1089.68	1137.00	1184.32	1231.59			180
200	814.40	863.57	912.72	961.90	1011.08	1060.19	1109.35	1158.54	1207.69				200
220	822.91	873.93	924.99	975.96	1027.01	1078.00	1129.01	1180.03					220
240	831.47	884.37	937.21	990.05	1042.91	1095.85	1148.74						240
260	839.99	894.72	949.44	1004.18	1058.91	1113.65							260
280	848.52	905.09	961.70	1018.25	1074.87								280
300	857.05	915.50	973.92	1032.37	1090.86								300
320	865.54	925.88	986.15	1046.46									320
340	874.11	936.23	998.39	1060.60									340

### Price Group 2

### Price Category C

Width Drop cm	80cm	100cm	120cm	140cm	160cm	180cm	200cm	220cm	240cm	260cm	280cm	300cm	Width Drop cm
60	766.63	805.72	844.87	884.00	923.11	962.24	1001.37	1040.56	1079.66	1118.77	1157.89	1197.04	60
80	776.60	817.98	859.33	900.68	942.08	983.42	1024.78	1066.14	1107.47	1148.86	1190.19	1231.56	80
100	786.63	830.27	873.80	917.42	960.97	1004.55	1048.18	1091.74	1135.33	1178.91	1222.48	1266.13	100
120	796.64	842.45	888.24	934.10	979.92	1025.72	1071.52	1117.31	1163.17	1208.98	1254.78	1300.63	120
140	806.66	854.71	902.72	950.78	998.79	1046.83	1094.93	1143.00	1191.06	1239.04	1287.09	1335.14	140
160	816.65	866.93	917.18	967.49	1017.74	1068.02	1118.31	1168.58	1218.85	1269.13	1319.38	1369.66	160
180	826.65	879.19	931.70	984.21	1036.69	1089.17	1141.68	1194.17	1246.72	1299.19			180
200	836.70	891.43	946.16	1000.87	1055.60	1110.33	1165.05	1219.78	1274.55				200
220	846.71	903.67	960.60	1017.61	1074.52	1131.50	1188.45	1245.45					220
240	856.72	915.90	975.09	1034.27	1093.46	1152.62	1211.85						240
260	866.75	928.15	989.53	1051.02	1112.39	1173.82							260
280	876.77	940.42	1004.10	1067.70	1131.33								280
300	886.76	952.62	1018.53	1084.36	1150.26								300
320	896.77	964.91	1032.94	1101.06									320
340	906.78	977.13	1047.43	1117.79									340

### Price Group 3

### Price Category C

Width Drop cm	80cm	100cm	120cm	140cm	160cm	180cm	200cm	220cm	240cm	260cm	280cm	300cm	Width Drop cm
60	797.31	837.96	878.66	919.36	960.05	1000.76	1041.42	1082.19	1122.83	1163.53	1204.20	1244.93	60
80	807.68	850.69	893.66	936.71	979.76	1022.78	1065.76	1108.78	1151.79	1194.81	1237.83	1280.84	80
100	818.12	863.48	908.74	954.12	999.44	1044.73	1090.09	1135.39	1180.77	1226.06	1271.39	1316.77	100
120	828.52	876.17	923.77	971.47	1019.13	1066.73	1114.41	1162.03	1209.69	1257.35	1304.97	1352.64	120
140	838.92	888.92	938.85	988.83	1038.77	1088.72	1138.73	1188.71	1238.67	1288.57	1338.57	1388.55	140
160	849.33	901.63	953.87	1006.19	1058.49	1110.72	1163.07	1215.30	1267.61	1319.90	1372.19	1424.47	160
180	859.72	914.33	968.92	1023.55	1078.17	1132.78	1187.35	1241.95	1296.58	1351.15			180
200	870.14	927.04	984.02	1040.93	1097.86	1154.74	1211.64	1268.58	1325.53				200
220	880.57	939.76	999.05	1058.27	1117.52	1176.75	1235.97	1295.26					220
240	891.00	952.57	1014.10	1075.68	1137.23	1198.74	1260.32						240
260	901.40	965.25	1029.13	1093.01	1156.88	1220.76							260
280	911.84	978.01	1044.24	1110.39	1176.57								280
300	922.25	990.72	1059.26	1127.78	1196.25								300
320	932.65	1003.48	1074.28	1162.53									320
340	943.06	1016.22	1089.34	1197.28									340

Supplied with standard 0928 rocker switch. Programmable rocker switch (0937) available as an optional accessory.

All prices shown exclude VAT



# Venetian Blinds

## SG 8250 (25mm)

Electrically operated Venetian Blind System.  
System with 24v motor 8060.

Maximum System Width: 300cm  
Minimum System Width: 65cm\*  
Maximum System Drop: 340cm  
Maximum Surface Area: 5m<sup>2</sup>

\* Please refer to Catalogue pages

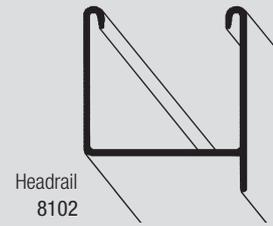
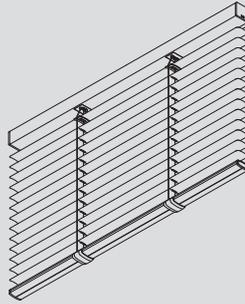

The prices in the tables below and on the following page comprise the complete system made-to-measure with 25mm slats ready to hang with universal snap bracket 8201. If sizes lie between the measurements shown, the price for the next size larger will apply. For multicoloured blinds add 20% to prices below for each colour. For side-guided/sloping version add 20% to prices below.

### Price Group 1

Price Category C

Width ▶ Drop ▼ cm	80cm	100cm	120cm	140cm	160cm	180cm	200cm	220cm	240cm	260cm	280cm	300cm	◀ Width ▼ Drop cm
60	740.80	773.95	807.13	840.33	873.44	906.61	939.80	972.96	1006.15	1039.32	1072.47	1105.66	60
80	747.27	781.88	816.47	851.10	885.68	920.31	954.92	989.53	1024.17	1058.78	1093.40	1127.97	80
100	753.71	789.78	825.86	861.88	897.97	934.02	970.07	1006.14	1042.16	1078.25	1114.25	1150.41	100
120	760.19	797.70	835.08	872.71	910.19	947.72	985.19	1022.73	1060.19	1097.69	1135.22	1172.73	120
140	766.68	805.59	844.53	883.48	922.42	961.38	1000.32	1039.29	1078.23	1117.17	1156.14	1195.04	140
160	773.10	813.52	853.90	894.32	934.69	975.07	1015.44	1055.83	1096.25	1136.62	1177.01	1217.42	160
180	779.59	821.39	863.23	905.09	946.94	988.79	1030.59	1072.38	1114.24	1156.10			180
200	786.04	829.35	872.66	915.89	959.20	1002.45	1045.67	1089.00	1132.26				200
220	792.52	837.26	881.98	926.69	971.42	1016.14	1060.84	1105.58					220
240	798.93	845.14	891.34	937.52	983.66	1029.84	1075.95						240
260	805.42	853.08	900.68	948.28	995.91	1043.53							260
280	811.89	861.02	910.03	959.10	1008.14								280
300	818.37	868.89	919.41	969.92	1020.40								300
320	824.87	876.82	928.74	980.69									320
340	831.27	884.71	938.08	991.52									340

### Price Group 2

Price Category C

Width ▶ Drop ▼ cm	80cm	100cm	120cm	140cm	160cm	180cm	200cm	220cm	240cm	260cm	280cm	300cm	◀ Width ▼ Drop cm
60	750.06	785.49	820.99	856.50	891.97	927.42	962.94	998.38	1033.89	1069.36	1104.83	1140.31	60
80	757.67	794.90	832.04	869.33	906.50	943.71	980.93	1018.15	1055.37	1092.59	1129.80	1167.01	80
100	765.29	804.22	843.17	882.10	921.04	960.02	998.98	1037.87	1076.76	1115.65	1154.54	1193.43	100
120	772.91	813.59	854.25	894.94	935.62	976.30	1016.95	1057.66	1098.37	1139.07	1179.77	1220.47	120
140	780.52	822.91	865.38	907.76	950.17	992.58	1035.01	1077.41	1119.81	1162.24	1204.67	1247.08	140
160	788.16	832.29	876.42	920.58	964.74	1008.87	1053.05	1097.13	1141.32	1185.47	1229.61	1273.76	160
180	795.76	841.62	887.49	933.43	979.27	1025.18	1071.03	1116.90	1164.31	1208.67			180
200	803.38	850.99	898.56	946.22	993.86	1040.25	1089.03	1136.67	1184.31				200
220	811.00	860.35	909.68	959.04	1008.37	1057.74	1107.11	1156.43					220
240	818.62	869.67	920.78	971.88	1022.90	1074.02	1125.08						240
260	826.26	879.05	931.87	984.71	1037.50	1090.27							260
280	833.87	888.47	942.97	997.54	1052.03								280
300	841.51	897.78	954.07	1010.31	1066.61								300
320	849.10	907.15	965.14	1023.18									320
340	856.73	916.47	976.21	1035.98									340

### Price Group 3

Price Category C

Width ▶ Drop ▼ cm	80cm	100cm	120cm	140cm	160cm	180cm	200cm	220cm	240cm	260cm	280cm	300cm	◀ Width ▼ Drop cm
60	768.51	808.63	848.74	888.86	928.93	969.03	1009.10	1049.20	1089.36	1129.44	1169.56	1209.64	60
80	778.45	820.85	863.24	905.72	948.11	990.52	1032.91	1075.35	1117.78	1160.20	1202.60	1244.99	80
100	788.40	833.11	877.85	922.57	967.26	1012.01	1056.75	1101.45	1146.11	1190.76	1235.41	1280.16	100
120	798.30	845.40	892.39	939.44	986.47	1033.53	1080.53	1127.53	1174.55	1221.55	1268.55	1315.71	120
140	808.25	857.62	906.94	956.26	1005.64	1054.99	1104.34	1153.67	1203.05	1252.35	1301.70	1351.08	140
160	818.20	869.86	921.49	973.18	1024.81	1076.43	1128.16	1179.78	1231.44	1283.07	1334.77	1386.41	160
180	828.14	882.08	936.05	990.02	1043.98	1097.96	1151.94	1205.90	1259.86	1313.80			180
200	838.03	894.34	950.62	1006.88	1063.18	1119.43	1175.69	1232.00	1288.26				200
220	847.97	906.59	965.16	1023.73	1082.36	1140.93	1199.52	1258.10					220
240	857.90	918.80	979.71	1040.63	1101.49	1162.43	1223.34						240
260	867.86	931.05	994.29	1057.47	1120.71	1183.90							260
280	877.78	943.30	1008.82	1074.33	1139.85								280
300	887.74	955.54	1023.37	1091.22	1159.06								300
320	897.61	967.77	1037.92	1108.10									320
340	907.58	980.03	1052.44	1124.96									340

Supplied with standard 0928 rocker switch. Programmable rocker switch (0937) available as an optional accessory.

All prices shown exclude VAT

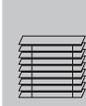

# Venetian Blinds

## SG 8300 (16mm)

Mono control Venetian Blind System.  
 Slats 16mm.  
 Maximum System Width: 3m  
 Minimum System Width: 50cm  
 Maximum System Drop: 3m  
 Maximum Surface Area: 4.5m<sup>2</sup>

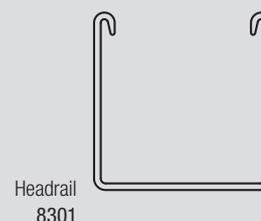
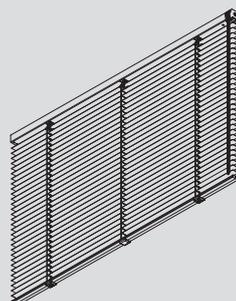

The prices in the tables below comprise the complete system made-to-measure with 16mm slats ready to hang. If sizes lie between the measurements shown, the price for the next size larger will apply. For side-guide or sloping add 20%.

### Price Group 1

Price Category C

Width ► Drop ▼ cm	60cm	80cm	100cm	120cm	140cm	160cm	180cm	200cm	220cm	240cm	260cm	280cm	300cm	◀ Width Drop cm
60	194.00	213.25	232.50	251.76	271.03	290.29	309.53	328.82	348.05	367.29	386.58	405.82	425.11	60
80	199.59	220.71	241.83	262.98	284.09	305.23	326.33	347.48	368.62	389.72	410.87	431.96	453.09	80
100	205.16	228.18	251.18	274.18	297.16	320.15	343.15	366.17	389.14	412.13	435.12	458.12	481.10	100
120	210.78	235.68	260.51	285.37	310.24	335.10	359.95	384.82	409.68	434.54	459.41	484.26	509.13	120
140	216.37	243.12	269.82	296.58	323.31	350.03	376.77	403.49	430.21	456.98	483.70	510.40	537.12	140
160	222.00	250.61	279.19	307.78	336.39	364.97	393.59	422.17	450.77	479.36	507.95	536.53	565.13	160
180	227.59	258.08	288.51	318.96	349.46	379.91	410.36	440.85	471.30	501.75	532.24			180
200	233.20	265.55	297.84	330.17	362.51	394.84	427.18	459.50	491.82	524.15				200
220	238.79	273.01	307.20	341.44	375.58	409.79	443.99	478.19	512.41					220
240	244.40	280.48	316.52	352.62	388.68	424.70	460.82	496.85						240
260	250.03	287.96	325.88	363.81	401.73	439.68	477.61							260
280	255.62	295.41	335.23	375.00	414.80	454.61								280
300	261.24	302.90	344.54	386.24	427.88	469.56								300

### Price Group 2

Price Category C

Width ► Drop ▼ cm	60cm	80cm	100cm	120cm	140cm	160cm	180cm	200cm	220cm	240cm	260cm	280cm	300cm	◀ Width Drop cm
60	200.13	221.43	242.78	264.07	285.37	306.66	328.00	349.31	370.63	391.95	413.24	434.56	455.86	60
80	207.80	231.67	255.52	279.39	303.24	327.12	350.98	374.81	398.69	422.56	446.40	470.26	494.11	80
100	215.45	241.86	268.29	294.68	321.12	347.50	373.89	400.33	426.75	453.15	479.55	505.99	532.37	100
120	223.12	252.06	281.03	309.99	338.94	367.89	396.90	425.84	454.78	483.76	512.72	541.68	570.66	120
140	230.76	262.28	293.80	325.28	356.81	388.33	419.82	451.37	482.87	514.38	545.89	577.41	608.97	140
160	238.40	272.47	306.54	340.62	374.68	408.69	442.79	476.87	510.92	544.99	579.07	613.11	647.20	160
180	246.07	282.69	319.27	355.93	392.51	429.12	465.74	502.36	538.97	575.51	612.22			180
200	253.70	292.88	332.03	371.22	410.38	449.57	488.74	527.88	567.06	606.22				200
220	261.35	303.05	344.82	386.52	428.25	469.95	511.67	553.40	595.13					220
240	269.05	313.27	357.56	401.82	446.10	490.39	534.63	578.90						240
260	276.66	323.49	370.30	417.14	463.96	510.78	557.59							260
280	284.33	333.69	383.04	432.45	481.80	531.18								280
300	291.98	343.92	395.83	447.75	499.67	551.61								300

### Price Group 3

Price Category C

Width ► Drop ▼ cm	60cm	80cm	100cm	120cm	140cm	160cm	180cm	200cm	220cm	240cm	260cm	280cm	300cm	◀ Width Drop cm
60	215.23	238.86	262.48	286.07	309.72	333.32	356.92	380.57	404.15	427.79	451.41	475.00	498.66	60
80	224.39	251.03	277.70	304.41	331.01	357.70	384.38	411.02	437.70	464.35	491.01	517.69	544.36	80
100	233.52	263.24	292.96	322.66	352.37	382.11	411.80	441.50	471.21	500.93	530.66	560.33	590.07	100
120	242.67	275.42	308.15	340.95	373.69	406.46	439.25	471.97	504.73	537.49	570.24	603.03	635.76	120
140	251.79	287.60	323.43	359.22	395.04	430.86	466.62	502.43	538.28	574.09	609.85	645.69	681.48	140
160	260.96	299.80	338.69	377.50	416.34	455.20	494.04	532.95	571.77	610.63	649.49	688.34	727.18	160
180	270.11	311.98	353.89	395.80	437.70	479.59	521.49	563.39	605.28	647.20	689.07			180
200	279.23	324.18	369.13	414.08	459.02	503.96	548.92	593.73	638.82	683.80				200
220	288.38	336.38	384.37	432.36	480.37	528.33	576.34	624.33	672.34					220
240	297.52	348.55	399.58	450.63	501.67	552.73	603.78	654.79						240
260	306.64	360.74	414.82	468.91	523.00	577.10	631.17							260
280	315.81	372.95	430.08	487.22	544.35	601.49								280
300	324.94	385.11	445.31	505.50	565.68	625.85								300

Child safety device (10482) – add on £11.43.

All prices shown exclude VAT



# Venetian Blinds

## SG 8300 (25mm)

Mono control Venetian Blind System.  
 Slats 25mm.  
 Maximum System Width: 3m  
 Minimum System Width: 50cm  
 Maximum System Drop: 3m  
 Maximum Surface Area: 4.5m<sup>2</sup>

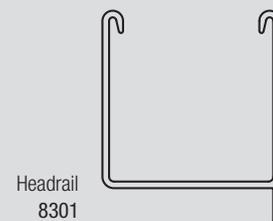
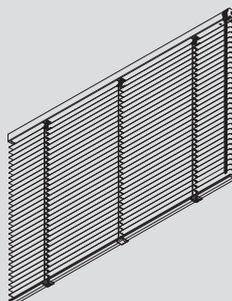

The prices in the tables below comprise the complete system made-to-measure with 25mm slats ready to hang. If sizes lie between the measurements shown, the price for the next size larger will apply. For side-guide or sloping add 20%.

### Price Group 1

Price Category C

Width ▶ Drop ▼ cm	60cm	80cm	100cm	120cm	140cm	160cm	180cm	200cm	220cm	240cm	260cm	280cm	300cm	◀ Width ▼ Drop cm
60	181.15	200.01	218.90	237.79	256.63	275.49	294.40	313.27	332.16	351.03	369.93	388.81	407.68	60
80	185.97	206.44	226.95	247.45	267.90	288.40	308.91	329.37	349.86	370.32	390.82	411.32	431.83	80
100	190.79	212.87	234.97	257.09	279.19	301.24	323.35	345.48	367.54	389.65	411.77	433.86	455.95	100
120	195.64	219.35	243.04	266.74	290.44	314.14	337.86	361.57	385.27	408.98	432.65	456.39	480.07	120
140	200.46	225.75	251.06	276.41	301.70	327.04	352.34	377.66	402.96	428.27	453.61	478.90	504.24	140
160	205.25	232.19	259.13	286.05	312.98	339.90	366.80	393.75	420.67	447.57	474.48	501.46	528.34	160
180	210.09	238.66	267.18	295.72	324.25	352.74	381.31	409.81	438.36	466.89	495.41			180
200	214.95	245.06	275.24	305.34	335.49	365.65	395.78	425.93	456.08	486.21				200
220	219.76	251.50	283.26	315.00	346.76	378.52	410.24	442.02	473.78					220
240	224.57	257.97	291.30	324.67	358.04	391.36	424.71	458.11						240
260	229.42	264.35	299.33	334.31	369.25	404.24	439.25							260
280	234.26	270.81	307.41	343.96	380.57	417.12								280
300	239.05	277.26	315.43	353.64	391.82	430.01								300

### Price Group 2

Price Category C

Width ▶ Drop ▼ cm	60cm	80cm	100cm	120cm	140cm	160cm	180cm	200cm	220cm	240cm	260cm	280cm	300cm	◀ Width ▼ Drop cm
60	186.42	207.06	227.72	248.33	268.99	289.61	310.27	330.90	351.54	372.18	392.84	413.45	434.10	60
80	193.02	215.85	238.70	261.51	284.37	307.19	330.03	352.88	375.70	398.55	421.36	444.18	467.04	80
100	199.60	224.61	249.66	274.69	299.74	324.74	349.81	374.81	399.85	424.89	449.92	474.95	499.98	100
120	206.18	233.42	260.66	287.89	315.12	342.33	369.56	396.78	424.04	451.24	478.45	505.68	532.95	120
140	212.80	242.22	271.63	301.04	330.47	359.92	389.31	418.75	448.17	477.61	507.03	536.44	565.85	140
160	219.37	250.99	282.60	314.26	345.84	377.47	409.10	440.72	472.34	503.96	535.55	567.20	598.82	160
180	225.96	259.76	293.59	327.40	361.24	395.05	428.87	462.68	496.47	530.30	564.14			180
200	232.52	268.56	304.56	340.58	376.60	412.58	448.62	484.66	520.67	556.67				200
220	239.15	277.34	315.57	353.74	391.97	430.18	468.39	506.61	544.83					220
240	245.72	286.10	326.54	366.90	407.35	447.75	488.14	528.57						240
260	252.31	294.91	337.50	380.13	422.70	465.32	507.93							260
280	258.92	303.71	348.52	393.31	438.09	482.88								280
300	265.48	312.50	359.48	406.47	453.47	500.48								300

### Price Group 3

Price Category C

Width ▶ Drop ▼ cm	60cm	80cm	100cm	120cm	140cm	160cm	180cm	200cm	220cm	240cm	260cm	280cm	300cm	◀ Width ▼ Drop cm
60	213.72	239.36	265.05	290.72	316.37	342.02	367.68	393.34	419.00	444.65	470.30	495.95	521.65	60
80	225.33	254.86	284.39	313.92	343.45	372.97	402.51	432.01	461.58	491.10	520.64	550.15	579.69	80
100	236.92	270.31	303.73	337.12	370.58	403.94	437.32	470.74	504.10	537.52	570.92	604.33	637.71	100
120	248.55	285.80	323.10	360.36	397.58	434.87	472.15	509.44	546.70	583.96	621.23	658.49	695.78	120
140	260.15	301.29	342.41	383.56	424.69	465.83	507.01	548.13	589.26	630.41	671.55	712.67	753.79	140
160	271.78	316.76	361.78	406.79	451.81	496.81	541.81	586.82	631.83	676.83	721.84	766.85	811.86	160
180	283.36	332.26	381.13	430.01	478.89	527.76	576.64	625.53	674.38	723.27	772.17			180
200	294.99	347.72	400.47	453.21	505.98	558.69	611.46	664.24	716.98	769.74				200
220	306.59	363.22	419.81	476.44	533.06	589.68	646.30	702.88	759.53					220
240	318.20	378.67	439.18	499.67	560.15	620.65	681.12	741.60						240
260	329.83	394.17	458.53	522.86	587.27	651.60	715.92							260
280	341.46	409.66	477.85	546.13	614.30	682.58								280
300	353.02	425.13	497.22	569.33	641.42	713.51								300

Child safety device (10482) – add on £11.43.

All prices shown exclude VAT



## Wooden Slat Venetian Blinds

### SG 8910

Mono control wooden slat Venetian Blind System.  
Bass wood slat 50mm.

### SG 8960

Electrically operated Venetian Blind System.  
Average operating speed 3cm/sec.

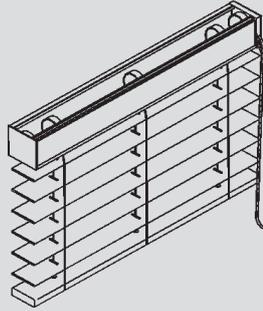

The prices in the table below comprise the complete system made-to-measure with 50mm slats ready to hang with universal bracket 8920. If sizes lie between the measurements shown, the price for the next size larger will apply. Headrail covered with actual slat to match. For F.R. treated wood please add £138.51/m<sup>2</sup> to prices below.

### SG 8910 – 50mm Slat size

Max. system width: 243cm      Min. system width: 65cm  
Max. system drop: 275cm      Max. surface area: 4.6m<sup>2</sup>

Price Category C

Width ▶ Drop ▼ cm	80cm	100cm	120cm	140cm	160cm	180cm	200cm	220cm	245cm	◀ Width ▼ Drop cm
80	335.37	413.62	439.11	544.02	566.53	654.87	716.01	744.00	807.73	80
90	343.34	422.76	449.37	558.06	581.86	671.41	736.31	765.70	830.79	90
100	351.31	431.88	459.59	572.08	597.11	687.97	756.60	787.36	853.81	100
110	363.24	445.58	474.99	593.03	620.02	712.79	787.04	819.78	888.24	110
120	384.36	502.01	502.01	607.03	635.34	729.32	807.35	841.45	911.28	120
130	405.49	494.94	529.04	621.03	650.62	745.86	827.65	863.11	934.28	130
140	423.32	515.35	551.96	649.11	681.20	778.96	868.19	906.38	980.27	140
150	430.02	522.99	560.60	659.60	692.68	791.40	883.46	922.63	997.54	150
160	436.67	530.61	569.18	670.08	704.12	803.86	898.67	938.86	1014.79	160
170	454.53	551.04	592.05	698.08	734.62	836.94	918.95	982.11	1060.80	170
180	473.31	572.85	616.14	726.76	765.59	870.98	939.28	1003.78	1083.77	180
190	492.09	594.63	640.27	755.40	796.49	904.96	979.83	1025.47	1106.75	190
200	506.27	610.90	658.55	777.76	820.83	931.35	1010.30	1057.94		200
210	515.77	621.73	670.74	792.65	837.08	948.93	1030.61			210
220	525.27	632.53	682.89	807.56	853.30	966.47	1050.89			220
230	544.16	654.17	707.24	837.25	885.80	1001.68	1091.45			230
240	551.31	662.31	716.38	848.45	897.97	1013.52				240
250	558.42	670.45	725.49	859.62	910.14	1028.06				250
260	577.33	692.08	749.84	889.40	942.62	1063.25				260
275	598.83	710.75	768.48	908.06	959.20					275

### 50mm Slat

Slat Description

Basswood Collection - Use above price chart		Bamboo Collection - Use above price chart plus 30%		Abachi Collection - Use above price chart plus 35%	
Alabaster	Sin	Arcana	Innocent	Aro	
Alpine	Soft White	Armour	Karri	Elkin	
Clay	Stark	Cinder	Mari	Hibano	
Golden Oak	Storm	Cyber	Neo	Kota	
Light Oak	Walnut	Dante	Zaya	Muriva	
Linen	Yarrin	Flax			
Mystic		Haze			

Wooden slat Venetian blinds are made with natural wood. It is therefore an inherent feature of the product that variation in shade and graining as well as slight warping may occur.

TAPED VENETIAN System 8910 is available with fabric tapes at an additional cost of 7·5%.

Please enquire at Silent Gliss for information about the colours available.

### SG 8960 – Electrically Operated Venetian Blind System (50mm wooden slat)

Max. system width: 243cm      Min. system width: 65cm  
Max. system drop: 275cm      Max. surface area: 4.6m<sup>2</sup>

Electrically operated with integral 230v motor no. 11095. Supplied with special recess switch 0613 as standard. For pricing, add to relevant price in table above the sum of **£940.90**

#### 8960 Control Options

Radio control standard option is with System 9940, see page 28.

Radio control option with integrated receiver available only with 9940 controls – add on £212.74, see page 28.

System 8960 is available with fabric tapes at an additional cost of 7·5%.

SIDE-GUIDES are available for both systems at an additional cost of £32.30.

All prices shown  
exclude VAT



# Aluminium Slat Venetian Blind

## SG 8910

Mono control Venetian Blind System.  
Aluminium slat 50mm.

## SG 8960

Electrically operated Venetian Blind System.  
Average operating speed 3cm/sec.

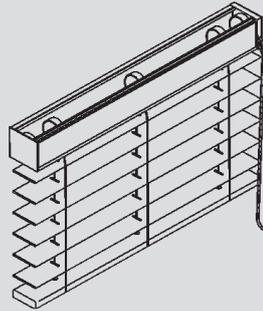

The prices in the table below comprise the complete system made-to-measure with 50mm slats ready to hang with universal bracket 8920. If sizes lie between the measurements shown, the price for the next size larger will apply. Headrail covered with actual slat to match. Plus coordinating or contrasting component options. Please refer to 8910 catalogue for recommended (standard) colour combinations. Multicoloured blinds please add 20% to prices below.

## SG 8910 – 50mm Slat size

Max. system width: 360cm      Min. system width: 65cm  
Max. system drop: 360cm      Max. surface area: 10m<sup>2</sup>

Price Category C

Width ▶ Drop ▼ cm	60cm	80cm	100cm	120cm	140cm	160cm	180cm	200cm	220cm	240cm	260cm	280cm	300cm	320cm	340cm	360cm	◀ Width ▼ Drop cm
60	138.09	174.43	210.83	247.11	283.52	319.80	356.27	392.66	428.99	465.32	501.59	538.03	574.37	610.73	647.12	683.45	60
70	141.93	178.35	214.60	251.00	287.40	323.73	360.07	396.40	432.79	469.22	505.55	541.89	578.24	614.52	650.97	687.28	70
80	145.83	182.22	218.50	254.89	291.19	327.60	363.98	400.29	436.60	472.99	509.33	545.77	582.11	618.39	654.73	691.18	80
90	149.65	186.00	222.39	258.72	295.10	331.42	367.84	404.13	440.49	476.86	513.24	549.58	585.89	622.29	658.59	695.00	90
100	153.50	189.86	226.21	262.60	298.91	335.29	371.68	408.03	444.32	480.76	517.06	553.44	589.78	626.12	662.49	698.85	100
110	157.34	193.67	230.09	266.40	302.80	339.13	375.48	411.89	448.18	484.62	520.92	557.25	593.55	629.98	666.38	702.74	110
120	161.16	197.61	233.88	270.26	306.69	342.96	379.37	415.70	452.06	488.18	524.78	561.14	597.46	633.81	670.19	706.54	120
130	165.05	201.46	237.77	274.11	310.43	346.81	383.18	419.58	455.94	492.27	528.62	564.97	601.38	637.75	674.06	710.35	130
140	168.91	205.27	241.68	277.94	314.35	350.67	387.03	423.37	459.79	496.10	532.43	568.90	605.19	641.57	677.94	714.26	140
150	172.74	209.13	245.49	281.82	318.19	354.57	390.93	427.29	463.60	499.93	536.23	572.70	609.03	1016.5	681.78	718.07	150
160	176.63	212.95	249.34	285.68	322.05	358.39	394.77	431.12	467.43	503.84	540.13	576.57	612.89	649.23	685.64	721.90	160
170	180.47	216.87	253.11	289.50	325.94	362.24	398.66	434.96	471.25	507.64	544.03	580.43	616.75	653.03	689.42	725.79	170
180	184.31	220.73	256.97	293.33	329.68	366.11	402.48	438.83	475.16	511.51	547.86	584.22	620.59	656.91	693.27	729.68	180
190	188.21	224.51	260.91	297.28	333.60	369.89	406.31	442.65	478.99	515.40	551.73	588.13	624.46	660.77	697.12	733.44	190
200	192.01	228.37	264.74	301.04	337.46	373.75	410.11	446.48	482.84	519.27	555.58	591.94	628.27	664.67	701.07	737.39	200
210	195.85	232.19	268.59	304.94	341.30	377.69	413.93	450.29	486.69	523.06	559.47	595.82	632.09	668.45	704.86	741.26	210
220	199.67	236.09	272.40	308.79	345.15	381.46	417.91	454.25	490.59	526.89	563.24	599.64	636.00	672.33	708.74	745.02	220
230	203.54	239.92	276.26	312.64	348.99	385.31	421.72	458.09	494.46	530.76	567.13	603.44	639.81	676.18	712.57	748.91	230
240	207.44	243.82	280.16	316.48	352.81	389.17	425.53	461.97	498.27	534.64	570.95	607.33	643.70	680.00	716.43	752.71	240
250	211.25	247.64	277.25	320.30	356.65	393.04	429.38	465.77	502.12	538.50	574.79	611.20	647.50	683.90	720.28	756.60	250
260	215.14	251.47	287.81	324.19	360.53	396.91	433.30	469.61	505.94	542.32	578.68	615.07	651.44	687.72	724.08	760.45	260
270	218.97	255.34	291.67	328.01	364.35	400.76	437.14	473.45	509.76	546.17	582.50	618.93	655.25	691.62	727.97	764.32	270
280	222.78	259.21	295.52	331.86	368.24	404.55	441.02	477.33	513.67	549.99	586.35	622.76	659.10	695.44	731.76	768.19	280
290	226.66	263.02	299.37	335.73	372.13	408.42	444.83	481.18	517.48	553.90	590.23	626.53	662.93	699.24	735.69	772.00	290
300	230.48	266.90	303.23	339.53	375.98	412.30	448.66	485.02	521.32	557.75	594.16	630.48	666.78	703.12	739.49		300
310	234.33	270.77	307.05	343.42	379.82	416.13	452.49	488.83	525.22	561.55	597.99	634.35	670.64	706.99	743.36		310
320	238.18	274.59	310.92	347.30	383.70	419.97	456.32	492.73	529.06	565.44	601.75	638.15	674.53	710.88			320
330	242.07	278.38	314.80	351.16	387.47	423.84	460.20	496.47	532.93	569.32	605.61	642.01	678.33	714.73			330
340	245.91	282.28	318.59	355.00	391.32	427.72	464.09	500.45	536.76	573.11	609.47	645.82	682.17				340
350	249.79	286.10	322.49	358.84	395.20	431.54	467.92	504.31	540.61	577.01	613.33	649.73	686.00				350
360	253.62	290.06	326.35	362.67	399.04	435.40	471.78	508.09	544.48	580.80	617.21	653.55	689.89				360

## SG 8960 – Electrically Operated Venetian Blind System (50mm aluminium slat)

Max. system width: 360cm      Min. system width: 65cm  
Max. system drop: 360cm      Max. surface area: 10m<sup>2</sup>

Electrically operated integral 230v motor no. 11095. Supplied with special recess switch 0613 as standard. For pricing, add to relevant price in table above the sum of £940.90

### 8960 Control Options

Radio control standard option is with System 9940, see page 28.

Radio control option with integrated receiver available only with 9940 controls – add on £212.74, see page 28.

System 8960 is available with fabric tapes at additional cost of 7.5%.

SIDE-GUIDES are available for both systems at an additional cost of £32.30

All prices shown exclude VAT

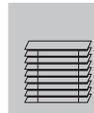

## Leather Slat Venetian Blinds

### SG 8910

Mono control leather slat Venetian Blind System with low descent mechanism (50mm).

### SG 8960

Electrically operated Venetian Blind System. Average operating speed 3cm/sec.

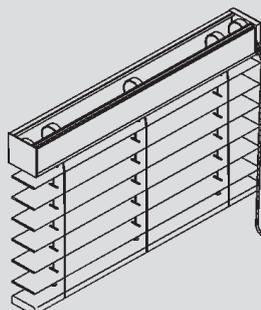

The prices in the table below comprise the complete system made-to-measure with 50mm slats ready to hang with universal bracket 8920. If sizes lie between the measurements shown, the price for the next size larger will apply. Plus coordinating or contrasting component options. Please refer to 8910 catalogue for recommended (standard) colour combinations. Leather venetian slats are a natural product, therefore slight variations in colour and texture are an inherent feature. Headrails are sprayed to match system colour as standard.

### SG 8910 – 50mm Slat size

Max. system width: 243cm      Min. system width: 65cm  
Max. system drop: 275cm      Max. surface area: 4.6m<sup>2</sup>

Price Category C

Width ► Drop ▼ cm	80cm	100cm	120cm	140cm	160cm	180cm	200cm	220cm	245cm	◀ Width ▼ Drop cm
80	670.24	799.12	944.66	1073.45	1216.82	1345.08	1473.88	1606.03	1734.27	80
90	731.17	875.22	1036.60	1180.63	1338.55	1482.56	1626.63	1773.37	1917.42	90
100	792.69	951.35	1127.94	1287.16	1460.86	1620.11	1778.80	1941.34	2100.57	100
110	853.61	1028.03	1219.82	1394.28	1583.19	1757.07	1931.50	2109.25	2283.73	110
120	914.53	1104.16	1311.15	1500.82	1704.94	1894.58	2084.26	2278.87	2468.51	120
130	976.06	1180.89	1403.08	1607.91	1827.29	2032.13	2238.64	2446.84	2651.67	130
140	1036.98	1257.01	1494.40	1714.43	1949.03	2171.29	2391.40	2614.76	2834.85	140
150	1097.87	1333.13	1586.34	1821.58	2071.34	2308.26	2543.54	2782.72	3017.98	150
160	1159.38	1409.87	1677.62	1928.14	2195.34	2445.81	2696.26	2950.65	3201.14	160
170	1220.28	1486.00	1769.55	2035.26	2317.09	2583.36	2849.02	3117.98	3384.27	170
180	1281.21	1562.68	1860.88	2144.04	2439.40	2720.30	3001.77	3311.48	3592.97	180
190	1342.74	1638.80	1952.83	2250.57	2561.74	2857.80	3154.49	3479.40		190
200	1403.64	1714.91	2045.81	2357.71	2683.47	2995.35	3332.16	3647.35		200
210	1464.57	1791.64	2137.70	2464.22	2805.78	3132.91	3484.92	3815.32		210
220	1526.04	1867.78	2229.04	2571.34	2928.12	3295.32	3637.61			220
230	1586.97	1946.14	2320.98	2677.87	3049.86	3432.89	3790.38			230
240	1647.88	2022.26	2412.31	2785.61	3197.72	3570.44				240
250	1708.78	2098.37	2503.61	2891.55	3319.45	3707.36				250
260	1770.32	2175.10	2595.51	2998.64	3441.76					260
275	1832.90	2251.23	2686.84	3131.30	3564.11					275

### SG 8960 – Electrically Operated Venetian Blind System (50mm leather slat)

Max. system width: 243cm      Min. system width: 65cm  
Max. system drop: 275cm      Max. surface area: 4.6m<sup>2</sup>

Electrically operated with integral 230v motor no. 11095. Supplied with special recess switch 0613 as standard. For pricing, add to relevant price in table above the sum of **£940.90**

#### 8960 Control Options

Radio control standard option is with System 9940, see page 28.

Radio control option with integrated receiver available only with 9940 controls – add on £212.74, see page 28.

**SIDE-GUIDES** are available for both systems at an additional cost of **£32.30**.

All prices shown exclude VAT

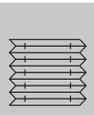

# Plissée Pleated Blinds

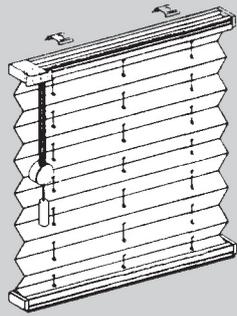

## SG 8500

Plissée Pleated Blind System supplied complete ready made. White aluminium head and bottom rail. Pleats 20mm.

Plissée Pleated Blind Systems are supplied made-to-measure, ready to install. White aluminium headrail and components are supplied as standard, brushed aluminium, grey and anthracite are also available. For special colours see page 75.

Please use our technical information leaflet to determine the required Plissée model and contact Silent Gliss for a price.

Choose from following model types:

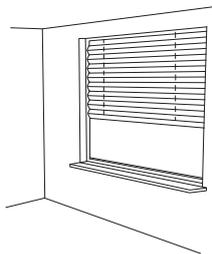

### Model Type 'A' – Vertical Freehanging

Electric Operation: AE10

Chain Operation: AK10

Pull Cord Operation: A010, A040, A070

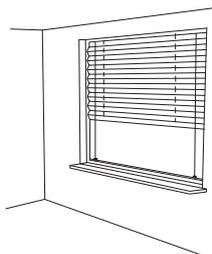

### Model Type 'B' – Vertical Side-Guide

Electrical Operation: BE10

Handle Operation: BB10, BB10U, BB15, BB20, BB20U, BB24, BB30, BB30U, BB34, BB35, BB40, BB80, BB81

Chain Operation: BK10

Pull Cord Operation: B010, B020, B030, B075

Fixed: BF50, BF51

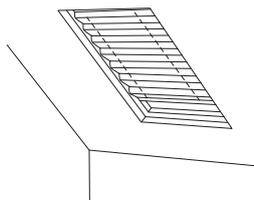

### Model Type 'D' – Inclined

Handle Operation: DB10, DB10U, DB20, DB20U

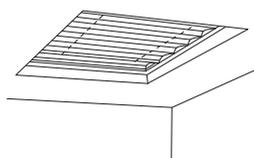

### Model Type 'P' – Horizontal

Handle Operation: PB10, PB40, PB41, PB60, PB61, PB70, PB71, PB80, PB81

Electrical Operation: PE10, PE11, PE60, PE61, PE70, PE71

Crank Operation: PR10, PR11

PRICING: Price on application – please contact Silent Gliss

All prices shown exclude VAT



## Logo and Digital Printing

We are able to print logos and images on a wide variety of fabrics, including Screens, Element, Mercurio and Colorama. It is important to note that the denser the fabric, the better the quality of the image transfer.

Suitable artwork must be provided on vector files with a reasonable size and high d.p.i. (dots per inch). Prices on application.

For more information please see Digital Printing brochure.

## Special Colours – Profile and Components

Standard stock colours are indicated and priced accordingly on the relevant system page.

In addition, any UK powder manufacturer's standard/stock RAL or BS colour may also be matched by spraying (delivery 4 weeks).

The following charges will apply:

	Price Qty.
<b>Set-up charge (1 per colour)</b>	<b>E</b>
Standard/Classic Range stock	
RAL or BS colours:	£285.50
Standard Silent Gliss colours (excluding chrome):	£136.00
Non-standard RAL or BS colours:	POA
<b>Plus add the following prices to the relevant assembled system price (use silver finish):</b>	
£8.06 per metre of profile	
£10.72 per set of endcovers/wall supports/endpieces/cord guides	
For tracks with sprayable brackets please use bracket spraying cost below.	
Note:	
Profile should not be bent once sprayed.	
Maximum sprayed profile length is 6 metres.	
Nylon components sprayed to colour match may sustain damage in the future.	

<b>Metropole Coloured Extension Brackets</b>	<b>E</b>
Set up charge:	£136.21 (Chrome only)
Spray charge:	£8.81 per bracket and bracket cover
Drilling charge:	£5.30 per bracket
Lead time approx. 6 weeks.	
<b>Note:</b> Universal Smart Fix brackets are unsuitable for Chroming.	



# Made-to-measure Curtains

## Wave

### CURTAIN HEADING SYSTEM

Curtain prices need to be added to the hardware prices. Prices are for unlined curtains.

For standard lining add 10% or for blackout lining add 15%.

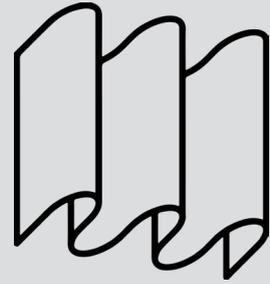

Price Category A

#### Price Group 1 Fabrics

Colorama 1  
Colorama 1 Alu  
Colorama 1 Bioactive  
Colorama 1 Eco  
Colorama 1 Multicolour  
Colorama Acoustic  
Colorama Acoustic Multicolour  
Oscurante  
Polyflax  
Someo

Width ► Drop ▼	150cm	200cm	250cm	300cm	350cm	400cm	450cm	500cm	550cm	600cm	◀ Width ▼ Drop
Up to 300cm	432.78	577.03	721.29	865.54	1009.81	1154.06	1298.32	1442.57	1586.82	1731.07	Up to 9'10"
301-350cm	648.44	865.54	1082.64	1299.74	1516.84	1733.94	1951.04	2168.14	2385.24	2602.34	9'10"-11'5"
351-400cm	745.57	995.52	1245.47	1495.42	1745.37	1995.32	2245.27	2495.22	2745.18	2995.14	11'5"-13'1"

#### Price Group 2 Fabrics

Colorama 2  
Colorama 2 Bioactive  
Colorama 2 Eco  
Colorama 2 Multicolour  
Leviso  
Leviso Light  
\*Somnia  
Valere

Width ► Drop ▼	150cm	200cm	250cm	300cm	350cm	400cm	450cm	500cm	550cm	600cm	◀ Width ▼ Drop
Up to 300cm	594.17	791.27	988.37	1185.48	1382.58	1579.68	1776.79	1973.89	2171.00	2368.10	Up to 9'10"
301-350cm	891.25	1186.91	1482.56	1778.22	2073.87	2369.53	2665.18	2960.84	3256.51	3552.17	9'10"-11'5"
351-400cm	1025.51	1365.44	1705.37	2045.31	2385.24	2725.17	3065.10	3405.03	3744.97	4084.90	11'5"-13'1"

#### Price Group 3 Fabrics

\*\*Colorama Dimout  
\*Deep  
Multicolor Dimout  
Reflex

Width ► Drop ▼	150cm	200cm	250cm	300cm	350cm	400cm	450cm	500cm	550cm	600cm	◀ Width ▼ Drop
Up to 300cm	1159.77	1545.41	1931.04	2316.68	2702.32	3087.96	3473.59	3859.23	4244.87	4630.50	Up to 9'10"
301-350cm	1739.65	2318.12	2896.56	3475.03	4053.48	4631.94	5210.39	5788.85	6367.31	6945.78	9'10"-11'5"
351-400cm	1999.60	2665.18	3330.76	3996.35	4661.93	5327.51	5993.09	6658.67	7324.25	7989.83	11'5"-13'1"

#### Fabric Joining Information for Wave® and SWISS Pleat Curtains

By reducing the number of joins the overall curtain appearance improves. The table below indicates the maximum drop available **without joins** for each fabric.

Max drop 170cm	Max drop 200cm	Max drop 240cm	Max drop 260cm	Max drop 280cm	Max drop 290cm	Max drop 300cm
Valere	Reflex	Colorama 1 Alu *Somnia	Leviso Leviso Light Oscurante Someo	**Colorama Dimout Multicolour Dimout *Deep	Colorama 1 Multicolour Colorama 2 Multicolour Colorama Acoustic Colorama Acoustic Multicolor Polyflax	Colorama 1 Colorama 1 Bioactive Colorama 1 Eco Colorama 2 Colorama 2 Bioactive Colorama 2 Eco

We recommend that if dim-out and black-out fabrics have to be made with joins (due to the drop required - see above table) then they should be lined to reduce pinholes.

\* Deep and Somnia are not suitable for use with 60mm Wave

\*\* Colorama Dimout is not suitable for drops over 2.8m

All prices shown exclude VAT

## Made-to-measure Curtains

# Swiss Pleat Curtain

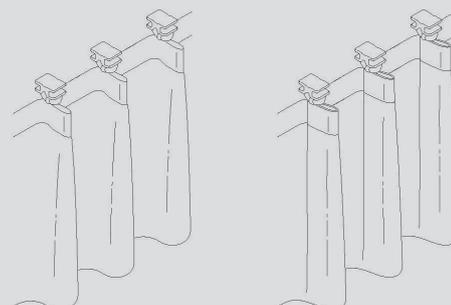

Curtain prices need to be added to the hardware prices.

Only available unlined.

### Single Pleat (Approximate fullness 50%)

Price Category A

#### Price Group 1 Fabrics

Colorama 1  
Colorama 1 Alu  
Colorama 1 Bioactive  
Colorama 1 Eco  
Colorama 1 Multicolour  
Colorama Acoustic  
Colorama Acoustic Multicolour  
Oscurante  
Polyflax  
Someo

Width ► Drop ▼	150cm	200cm	250cm	300cm	350cm	400cm	450cm	500cm	550cm	600cm	◀ Width ▼ Drop
Up to 300cm	341.50	455.30	569.08	682.87	796.66	910.46	1024.25	1138.05	1251.85	1365.65	Up to 9'10"
301-350cm	512.26	682.94	853.62	1024.30	1194.98	1365.66	1536.34	1707.02	1877.71	2048.39	9'10"-11'5"
351-400cm	589.10	785.38	981.63	1177.94	1374.22	1570.50	1766.78	1963.06	2159.34	2355.62	11'5"-13'1"

#### Price Group 2 Fabrics

Colorama 2  
Colorama 2 Bioactive  
Colorama 2 Eco  
Colorama 2 Multicolour  
Leviso  
Leviso Light  
Somnia  
Valere

Width ► Drop ▼	150cm	200cm	250cm	300cm	350cm	400cm	450cm	500cm	550cm	600cm	◀ Width ▼ Drop
Up to 300cm	468.26	622.22	780.43	936.51	1092.60	1249.10	1404.77	1560.85	1716.94	1873.02	Up to 9'10"
301-350cm	702.39	936.51	1170.63	1433.37	1638.88	1873.00	2107.12	2341.24	2575.37	2809.49	9'10"-11'5"
351-400cm	807.74	1076.98	1346.25	1615.46	1884.70	2153.94	2423.18	2692.42	2961.66	3230.90	11'5"-13'1"

#### Price Group 3 Fabrics

Colorama Dimout  
Deep  
Multicolor Dimout  
Reflex

Width ► Drop ▼	150cm	200cm	250cm	300cm	350cm	400cm	450cm	500cm	550cm	600cm	◀ Width ▼ Drop
Up to 300cm	778.50	1037.99	1297.49	1556.99	1816.49	2075.99	2335.49	2594.99	2854.48	3113.98	Up to 9'10"
301-350cm	1167.75	1556.99	1946.23	2335.48	2724.72	3113.96	3503.20	3892.45	4281.69	4670.93	9'10"-11'5"
351-400cm	1342.91	1790.54	2238.17	2685.80	3133.42	3581.05	4028.68	4476.31	4923.93	5371.56	11'5"-13'1"

### Double Pleat (Approximate fullness 100%)

#### Price Group 1 Fabrics

Colorama 1  
Colorama 1 Alu  
Colorama 1 Bioactive  
Colorama 1 Eco  
Colorama 1 Multicolour  
Colorama Acoustic  
Colorama Acoustic Multicolour  
Oscurante  
Polyflax  
Someo

Width ► Drop ▼	150cm	200cm	250cm	300cm	350cm	400cm	450cm	500cm	550cm	600cm	◀ Width ▼ Drop
Up to 300cm	455.34	607.13	758.91	910.69	1062.47	1214.25	1366.03	1517.81	1669.60	1821.38	Up to 9'10"
301-350cm	683.01	910.69	1138.37	1366.04	1593.72	1821.40	2049.08	2276.75	2504.43	2732.11	9'10"-11'5"
351-400cm	785.46	1047.29	1309.12	1570.95	1832.78	2094.61	2356.44	2618.27	2880.10	3141.94	11'5"-13'1"

#### Price Group 2 Fabrics

Colorama 2  
Colorama 2 Bioactive  
Colorama 2 Eco  
Colorama 2 Multicolour  
Leviso  
Leviso Light  
Somnia  
Valere

Width ► Drop ▼	150cm	200cm	250cm	300cm	350cm	400cm	450cm	500cm	550cm	600cm	◀ Width ▼ Drop
Up to 300cm	624.39	832.52	1040.66	1248.79	1456.92	1665.05	1873.18	2081.31	2289.44	2497.57	Up to 9'10"
301-350cm	936.59	1248.79	1560.98	1873.17	2185.36	2497.55	2809.74	3121.93	3434.12	3746.32	9'10"-11'5"
351-400cm	1077.09	1436.11	1795.13	2154.15	2513.18	2872.20	3231.22	3590.24	3949.26	4308.29	11'5"-13'1"

#### Price Group 3 Fabrics

Colorama Dimout  
Deep  
Multicolor Dimout  
Reflex

Width ► Drop ▼	150cm	200cm	250cm	300cm	350cm	400cm	450cm	500cm	550cm	600cm	◀ Width ▼ Drop
Up to 300cm	1038.05	1384.06	1730.08	2076.09	2422.11	2768.13	3114.14	3460.16	3806.17	4152.19	Up to 9'10"
301-350cm	1557.08	2076.09	2595.11	3114.13	3633.15	4152.17	4671.19	5190.21	5709.22	6228.24	9'10"-11'5"
351-400cm	1790.64	2387.51	2984.39	3581.26	4178.14	4775.01	5371.89	5968.78	6565.66	7162.55	11'5"-13'1"

Fabric joining information, please see table on page 75

All prices shown exclude VAT

# Price Index for Rails & Parts

All prices shown  
exclude V.A.T.

Product	Description	Unit Prices					Per Metre Price				Qty
		Each	Per 10	Per 100	Other Qty	Price	1m	100m	Other Lgth	Price	
18R	Round Head Screw No.8, 25mm/1"			18.55							A
28C	Counter Sunk Screw No.8, 50mm/2"			23.02							A
0286	Cable Clips	0.14									A
0270	RACUB Module	480.23									C
0323	0.5m Blue patch cable	2.21									C
0565	Non latching recess switch, white, 1 gang	122.33									C
0566	Non latching recess switch, white, 2 gang	211.76									C
0567	Non latching recess switch, white, 3 gang	329.76									C
0568	Non latching recess switch, white, 4 gang	419.21									C
0569	Non latching recess switch, white, 6 gang	632.88									C
0593	Gland set for 5682	4.25									C
0614ST	Wireless switch, white	138.76									C
0615	Mains Switch, white, 1 gang, including back box	66.07									C
0616	Latching recess switch, white, 2 gang	89.04									C
0617	Latching recess switch, white, 3 gang	144.70									C
0618	Latching recess switch, white, 4 gang	174.01									C
0619	Latching recess switch, white, 6 gang	241.15									C
0661	Side guide wire						1.06				A
0839	Knot Holder	0.56									A
0921	Booster for 0450 system	567.32									C
0922	Power supply for 0921 booster	141.83									C
1003p	(New code 11606) Rail, silver, white, matt white, Ecu in 6 metre lengths only						24.11				A
1003p	(New code 11606) Rail, gunmetal, Charcoal, in 6 metre lengths only Chrome (4 metre lengths only)						32.97				A
1021p	Rail, silver in 5 metre or 6 metre lengths only						7.73				A
1021p	Rail, silver, cut to size						8.46				A
1021p	Rail, white, 6 metre lengths only						16.64				A
1021p	Rail, white, cut to size						17.36				A
1025p	Rail, silver in 5 metre or 6 metre lengths only						7.73				A
1025p	Rail, silver, cut to size						8.46				A
1025p	Rail, white, in 6 metre lengths only						16.64				A
1025p	Rail, white, cut to size						17.36				A
1071	Rail, white in 6 metre lengths only						9.70				A
1071	Rail, white cut to size						10.67				A
1072	Endcap for 1070 Hand, white.		5.76	54.88							A
1080p	Rail, silver in 5 metre or 6 metre lengths only						10.31				A
1080p	Rail, silver, cut to size						11.27				A
1080p	Rail, white, in 5 metre or 6 metre lengths only, black in 6m lengths (Black available from 1st April 2023)						10.87				A
1080p	Rail, white, black cut to size (Black available from 1st April 2023)						12.11				A
1080p	Rail, matt white, anodic grey, antique bronze, charcoal in 6m. lengths only						22.27				A
1080p	Rail, matt white, anodic grey, antique bronze, charcoal cut to size						23.30				A
1082	Rail, white, in 5 metre or 6 metre lengths only (System 3000)						20.05				A
1082	Rail, white, cut to size (System 3000)						20.72				A
1090p	Rail, silver in 5 metre or 6 metre lengths only						8.83				A
1090p	Rail, silver, cut to size						9.60				A
1090p	Rail, white in 5 metre or 6 metre lengths only						9.14				A
1090p	Rail, white, cut to size						10.07				A
1105	Spacer	0.92	8.74	82.77							A
1128C	Counter sunk screw No.8, 37mm/1 1/2"			29.76							A
1128R	Round head screw No.8, 37 mm/1 1/2"			29.76							A
1148C	Counter sunk screw No.8, 31mm/1 1/4"			22.50							A
1280p	Rail, white, in 5/6 m lengths						14.70				A
1348R	Round head screw No.8, 44mm/1 3/4"			32.79							A
2006	Aluminium weight bar (4 metre length max) 28mm						17.10				A
2049	Gear Drive	32.91	313.32	2847.37							A
2059	Safety Clip		11.79								A
2081	Take up reel, 2120 system	14.68	131.64								A
2091	Endcover (for 2135 steel rod)	1.37	12.61	120.05							A
2093	Ring		3.11	29.43							A
2111	Hexagonal bar							6m	110.71		A
2111	Hexagonal bar, outer of 50 lengths							6m	83.01		A
2116	Touch and close profile							5m	115.31		A
2116	Touch and close profile, outer of 40 lengths							5m	103.77		A
2131	Short end-cover	2.22	19.81								A
2135	Steel rod							3m	10.19		A
2136	Tubular tape (for 2135 steel rod)							222.21			A
2136CR	Tubular tape, cream							228.19			A
2138	T bracket A, silver, white with 1 riveted clamp	49.86									C
2139	T bracket A, silver, white with 2 riveted clamps	50.28									C
2143	Cord connector	2.17	19.56								A
2144	Cross rail							4m	65.45		C
2145	Glider, wide channel for side rails	1.63	15.63								C
2151	Rail, silver in 6 metre lengths only						128.36				C
2151	Rail, silver, cut to size						141.24				C
2156	Drive shaft						16.60	6m	90.48		C
2160	Motor	1325.31									C
2163	Flat drawing tape 6mm							200m	528.28		A
2164	Ring tape							200m	728.37		A
2164T	Transparent ring tape							50m	182.10		A
2179	Endcover for 2211	1.88	17.69								A
2182	Sleeve and pin, pair				2.00	16.64					C
2188	Glider Insert for 2144	1.50	14.40								C
2189	Gear, system 2190	216.17									C
2191	Rail, silver, 6 metre lengths only						27.10				C

## Price Index for Rails &amp; Parts

All prices shown  
exclude V.A.T.

Product	Description	Unit Prices				Per Metre Price				Qty	
		Each	Per 10	Per 100	Other Qty	Price	1m	100m	Other Lgth		Price
2191	Rail, silver, cut to size						29.81				C
2191	Rail, white, 6 metre lengths only						28.80				C
2191	Rail, white, cut to size						31.67				C
2192	Belt drive endpiece set	15.40									C
2192W	Belt drive endpiece set, white	16.11									C
2193	Belt return set	15.40									C
2193W	Belt return set, white	15.73									C
2198	Pencil pleat tape							50m	357.75		A
2199	Oval wooden weight section							3m	19.47		A
2211	Velcro Profile					42.40		6m	231.16		A
2216	Cord							1000m	329.19		A
2221	Hook tape							100m	658.39		A
2230	Set, white, grey	32.33									C
2242	Connector	41.25									C
2248	Cross rod							6m	105.87		C
2255	Adjustable brake, white, black (Black available from 1st April 2023)	8.85	84.34								A
2256	Adjustable brake, white, black (Black available from 1st April 2023)	8.85	84.34								A
2301	Profile White							5.8m	77.07		A
2301	Profile, Black (Available from 1st April 2023)							5.8m	92.48		A
2302	Clip bracket	1.38									A
2302	Clip bracket, Black (Available from 1st April 2023)	1.66									A
2307	Gear/Breakaway set (4:1) White	18.50									A
2307	Gear/Breakaway set (4:1), Black (Available from 1st April 2023)	22.20									A
2308	Spool with lift cord, White, 2305 systems	6.52									A
2308	Spool with lift cord, Black 2305 systems (Available from 1st April 2023)	7.82									A
2309	Hexagonal Bar							5m	10.77		A
2310	Plastic bead chain, White (To be discontinued 2023, subject to availability)							250m	161.62		A
2311	Metal bead chain (2305)							150m	386.08		A
2311/AB	Metal bead chain, Antique Brass (2305)							150m	692.76		A
2311/BL	Metal bead chain, Pewter (2305)							150m	692.76		A
2311/GD	Metal bead chain, Gold (2305)							150m	692.76		A
2312	Bead chain joiner	0.60									A
2317	Gear without breakaway mechanism (4:1)	12.21									A
2317	Gear without breakaway mechanism (4:1) Black (Black available from 1st April 2023)	14.65									A
2319	Plastic chain joiner	0.12									A
2346	Clamp bracket	1.94									A
2346	Clamp bracket, Black (Available from 1st April 2023)	2.33									A
2347/50	50cm drop plastic chain loop, White (To be discontinued 2023, subject to availability)	1.50									A
2347/75	75cm drop plastic chain loop, White (To be discontinued 2023, subject to availability)	1.68									A
2347/100	100cm drop plastic chain loop, White (To be discontinued 2023, subject to availability)	1.92									A
2347/125	125cm drop plastic chain loop, White (To be discontinued 2023, subject to availability)	2.21									A
2347/150	150cm drop plastic chain loop, White (To be discontinued 2023, subject to availability)	2.45									A
2347/175	175cm drop plastic chain loop, White (To be discontinued 2023, subject to availability)	2.69									A
2347/200	200cm drop plastic chain loop, White (To be discontinued 2023, subject to availability)	3.11									A
2363	Wall/ceiling bracket for 2350	4.92									A
2471	Bottom weight 5"/127mm	1.30		124.17							C
2473	Bottom weight 3½"/89mm	1.03		96.87							C
2479	Link chain 5"/127mm					1.21		500m	541.08		C
2481	Link chain 3½"/89mm					1.21		500m	541.08		C
2521	Face Fix Bracket (49.6mm)	2.12									C
2539	Touch and close pile section						220.89	25m	61.37		A
2573	Master Carrier for Electric Panel System	15.44									C
2601	Profile only, white					30.75					C
2601	Profile only, silver					30.01					C
2604	Guide	6.73									C
2605	Top clip 127mm each, white	0.50		43.81							C
2606	Reducing Top clip 127mm for 2810	0.96		90.23							C
2608	Endstop for 2601	15.87									C
2610	Endstop	2.44									C
2611	Stopper	2.20									C
2612	Brake	4.03									C
2613	Connector	18.11									C
2615	Recess profile					23.55					C
2616	Bracket, white	4.97									C
2616	Bracket, silver	2.73									C
2618	Shaft	1.20									C
2620	Pilot Runner	8.39									C
2623	Rotation element (123mm)	2.95									C
2624	Rotation element (101mm)	2.95									C
2625	Rotation element (89mm)	2.95									C
2671	Bottom weight 89mm/3 1/3" without horns			124.17							C
2672	Bottom weight 127mm/5" without horns			96.87							C
2759	Crossrail, 0.13mm							4m	41.48		C
2813	Top clip 89mm, white	0.50		43.81							C
2821	Spacer (65mm)	0.98									C
2826	Chain connector	1.55	14.83								A
2849	PVC top clip			56.39							C

# Price Index for Rails & Parts

All prices shown  
exclude V.A.T.

Product	Description	Unit Prices					Per Metre Price				Ctgy
		Each	Per 10	Per 100	Other Qty	Price	1m	100m	Other Lgth	Price	
2865	Twin connector	2.03									C
2872	Plastic operating chain, white						3.75	250m reel	928.27		C
2872	Plastic operating chain, black						12.12	250m reel	2978.85		C
2932	Rail, white, 6 metre lengths only						39.71				C
2932	Rail, white, cut to size						43.68				C
2941	Wedge	5.87									C
2948	Rail, white, 5 metre lengths only						94.46				C
2948	Rail, white, cut to size						103.94				C
3003	Clamp		53.19	478.68							C
3004	Clamp		16.68	150.23							A
3008	Connecting bridge	13.52									A
3016	Endstop	0.59		44.02							A
3016	Endstop, Euroslot sachet of 2	2.29									A
3017	(New Code 11335) Endstop	1.17		105.34							A
3030	Pilot runner	2.42		212.63							A
3032	Spring Stop		9.69	87.02							A
3033	Clamp for 2900	3.16	28.45								C
3041	Clamp	8.51	85.06								A
3044	Clamp	2.12									C
3045	Metal overlap	5.00	45.04								A
3060	Clamp for 6465	0.73	7.28	72.74							A
3062	Connecting bridge for 1020 / 6465	3.23									A
3067	Connecting bridge for 6243 profile	4.71									A
3068A	Loop tape							250mtr Reel	747.11		A
3069	Child Safety Eyelet	0.79		77.34							A
3070	Twist eye endstop, white, black (Black available from 1st April 2023)	0.88	7.82	69.85							A
3071	Screw twist endstop	3.28	31.16								A
3073	Bottom tape adjuster	0.46	3.44								A
3089	Glider with hook				20.00	12.47					A
3090	Cord							164.73			A
3090A	Cord								500m	780.95	A
3091	Cord, black							164.73			A
3096	Connecting bridge 1090	17.49	166.63								A
3113	5cm spacer 1090		24.87	223.83							A
3151	Clearance spacer (for top boards)			77.68							A
3164	Hook & Latch Set	1.77		172.33							A
3165	Breakway Ring Set Softfold	1.14		111.27							A
3166	Breakway Ring Set Softfold Tape (per metre)						10.63				A
3175	Universal nylon bracket for 1090/1200 system	1.59	14.70	87.88							A
3176	Top fix bracket 1090/1200, white	1.59	14.70	87.88							A
3181	L' bracket A, silver, white with 1 riveted clamp	10.48									C
3208A	Intermediate pulley, 3000, white	44.90	408.73								A
3213	Adjustable carrier 3000	3.40		300.99							A
3231	Endfix bracket 3000	11.79	111.89								A
3242	Nylon overlap	3.66	32.37	259.36							A
3242	Nylon overlap, Euroslot sachet of 1	4.70									A
3288	Endpiece set 3000, white	37.69			25.00	840.52					A
3289	Endpiece set, grey	39.04									A
3289	Endpiece set, white	41.54									A
3511	Glider			14.32	25000.00	2873.96					A
3532	Glider			30.36	5000.00	1216.73					A
3533	Glider, white, black (Black available from 1st April 2023)			16.05	25000.00	3210.97					A
3533	Glider, white sachets of 25 x 25	99.20									A
3533	Glider, white Euroslot sachets of 25	5.25									A
3534	Glider in strip form, white, black (Black available from 1st April 2023)				1000.00	137.35					A
3548	Retrofit glider				25.00	7.41					A
3548	Retrofit glider			27.06	1000.00	270.01					A
3562	Standard tape							278.36			A
3570	Rotating glider		3.53	30.85							A
3571	Hook			14.14	35000.00	4153.69					A
3571	Hook, sachet of 25 x 25	94.42									A
3571	Hook, Euroslot sachet of 25	4.79									A
3580	Glider/hook			57.03	5000.00	2720.67					A
3582	Plastic hook, white, black (Black available from 1st April 2023)			12.55							A
3582	Plastic hook, white sachets of 25 x 25	105.46			625.00	105.44					A
3582	Plastic hook, white, black outer 20000 (Black available from 1st April 2023)				20000.00	2230.38					A
3582	Plastic hook, white, black outer 1000 (Black available from 1st April 2023)				1000.00	117.40					A
3582	Plastic hook, white Euroslot sachets of 25				25.00	4.42					A
3599	2 prong hook, white, black (Black available from 1st April 2023)			19.69	25000.00	3750.55					A
3599	2 prong hook, white sachets of 25 x 25	150.48									A
3599	2 prong hook, white Euroslot sachets of 25	6.48									A
3600	Picture hanging set	26.56									A
3602	Wall support 1080, white	6.02	54.62								A
3603	Top fix bracket, white, black (Black available from 1st April 2023)	2.13	19.40	176.63							A
3603	Top fix bracket, Euroslot sachets of 2, white	5.55									A
3604	Nylon Corner Piece (White Only)	4.12									A
3605	Endcover 1080, white, black (Black available from 1st April 2023)	2.97	27.02	257.37							A
3606	Snap fastener 1080	1.50	11.79								A
3611	Ceiling stud 1085	2.63									A
3612	Sleeve for 3610	5.81									A
3618	Metal wall support	8.36	75.25								A
3620	Connecting bridge	15.80	148.10								A

# Price Index for Rails & Parts

All prices shown  
exclude V.A.T.

Product	Description	Unit Prices					Per Metre Price				Ctgy
		Each	Per 10	Per 100	Other Qty	Price	1m	100m	Other Lgth	Price	
3626	Return fixing bracket	5.03	45.23								A
3630	Universal nylon bracket, white, black	2.05	16.28	148.14							A
3630	Universal nylon bracket, white Euroslot sachet of 2	5.34									A
3630	Universal nylon bracket, gold, brown	2.29	20.55								A
3634	Height adjuster	4.61									A
3637A	Cord							500m	376.84		A
3638	Re-inforced corner piece, grey, white	3.46	31.53	287.30							A
3639	Hanger rod assembly complete	26.68									A
3655	Long universal bracket	3.48	33.12	301.40							A
3660	Extra long universal bracket	4.33									A
3660	Extra long universal bracket, Euroslot sachet of 1	5.66									A
3663	Profile hook	4.00									A
3667	Endcover/stop, white, grey, black (Black available from 1st April 2023)	1.62	15.59	148.67							A
3667	Endcover/stop, white, grey, Euroslot sachets of 2	4.53									A
3667	Endcover/stop, matt white, anodic grey, antique bronze, charcoal	3.33	31.68	301.68							A
3802	Connecting bridge	17.43									A
3825	Clamp		24.76	236.94							A
3826	Top fix bracket, white, black (Black available from 1st April 2023)	1.63	14.85	133.73							A
3832	Twist clamp	3.12									A
3833A	Intermediate pulley, white, black (Black available from 1st April 2023)	64.17									A
3833A	Intermediate pulley - Matt white, grey, anodic grey, antique bronze, charcoal	70.17									A
3836	Face fix bracket, White	3.37									A
3841	Rail, silver, white, black in 6 metre lengths only (Black available from 1st April 2023)						22.02				A
3841	Rail, silver, white, black cut to size (Black available from 1st April 2023)						24.46				A
3841	Rail, matt white, anodic grey, antique bronze, charcoal in 6 metre lengths only						39.13				A
3841	Rail, matt white, anodic grey, antique bronze, charcoal, cut to size						41.32				A
3842	Endcap for 6840 Hand, white, grey, black (Black available from 1st April 2023)	0.60	5.39	47.89							A
3842	Endcap for 6840 Hand, anodic grey, antique bronze, charcoal, silver	5.15	49.06	466.89							A
3845	Endpiece set, white, grey, black (Black available from 1st April 2023)	21.39									A
3845	Endpiece set, matt white, anodic grey, antique bronze, charcoal	28.84									A
3846	Endpiece set, white, grey	29.58									A
3914	Bracket for return profile	17.68									A
3915	Endpiece set				20.00	484.21					A
3915	Endpiece set				50.00	1089.96					A
3916	Pilot runner for multi-stack system	2.05	18.25								A
3917	Pilot runner	2.80		266.73							A
3922	Roller gliders in strip form, outer of 1000				1000.00	553.78					A
3922	Roller gliders in strip form, outer of 8000				8000.00	3826.29					A
3929A	Intermediate pulley	69.46	661.30								A
3932	Spring stop	1.00	9.52								A
3933	Click glider in strip form, outer of 1000				1000.00	351.85					A
3935	Overlap arm (System 3900)	26.14	249.13								A
3935A	Combination overlap with 'S' hook attachment 3949	29.45	280.50								A
3936	Overlap arm (System 3900)				20.00	263.78					A
3936A	Combination overlap with 'S' hook attachment 3949	17.70	168.50								A
3939	Pilot runner	2.38		228.62							A
3942	Intermediate stop	4.00	38.85								A
3947	Pair of magnetic gliders		113.29								A
3971	Rail, white in 6 metre lengths only						26.94				C
3971	Rail white cut to size						29.63				C
3975	Overlap for pulling by hand (1280)	50.02	476.40								A
3982	Rail, white, available in 5 metre or 6 metre lengths						23.02				A
3985	Endcover in white 1280			255.32							A
4221	Bottom weight bar, white, silver or black (To be discontinued on the 1st April 2023)						22.94				C
4223	Plastic strip with adhesive 12mm						4.04				C
4226	Standard adhesive tape, 30mm								54m	357.57	C
4845	Metal bead chain (2020/2120)								125m	590.61	A
4845BR	Metal bead chain, brass (2020/2120)								125m	1110.84	A
5118	Wedge, white, black (Black Available from 1st April 2023)	6.34									C
5130	Drive belt for 2190/2195						14.71				C
5190	Motor 100-250V AC with 5 Metre lead	278.93									A
5192	Motor 24V DC	299.85									A
5193	Motor 100-250V AC with mains control	404.07									A
5339	Lead with in-line connector	122.51									C
5670	Overlap	76.65									C
5682	Hood	18.11									C
5684	Connector	38.84									C
5736	Surface Relay Socket	178.07									C
5778	Special plug for cable 5779, pair	4.26			2.00	8.53					C
5779	4 core low voltage connecting cable						5.82				C
5782ST	Single Channel radio handset white	123.99									C
5784ST	Multi channel radio handset white	163.41									C
5805	Motor for 5800	13180.54									C
5806	Pilot runner	37.66									C
5809	Roller glider		127.39								C
5810	Profile						133.07				C
5811	Overlap	258.53									C
5813	Floor frame	1621.31									C
5814	Cable						40.31				C
5815	Cord guide return	380.91									C

# Price Index for Rails & Parts

All prices shown  
exclude V.A.T.

Product	Description	Unit Prices					Per Metre Price				Qty
		Each	Per 10	Per 100	Other Qty	Price	1m	100m	Other Lgth	Price	
5816	Cord guide	498.30									C
5824	Endstop	40.97									C
5829	2 hole fixing plate	11.77									C
5834	Double pilot	276.17									C
6010p	Rail, white, black in 6 metre lengths only (Black available from 1st April 2023)						20.51				A
6010p	Rail, white, black, cut to size (Black available from 1st April 2023)						22.55				A
6018	Endcap, white, black for 6010 (Black available from 1st April 2023)		7.22	68.72							A
6021p	Rail, white, in 6 metre lengths						13.93				A
6024	Panel glide connecting bridge	15.04									C
6053	Spring stop	1.63	15.10								A
6063	Overlap	12.95	117.72	1100.24							A
6063R	Overlap arm with rollers for 30mm Corded	22.39									A
6064	Screw twist endstop, white	1.57	13.36								A
6065	Twist eye endstop, white, black (Black available from 1st April 2023)	1.38	12.68	116.60							A
6070	Cord 6200/6370							461.86			C
6079	Overlap	42.12									C
6086	Spring stop, white, black (black available from 1st April 2023)	2.30	21.63	196.42							A
6094	Roller glider with hook		37.90	360.58							A
6098	Roller glider with eye, white, black (Black available from 1st April 2023)		31.97	303.24							A
6099	Wave roller glider (80mm) white								50m	3316.62	A
6101	Rail, white in 4.5m, 5m, 5.5m, 6m, 6.75m lengths only						38.38				A
6101	Rail, silver in 4.5m, 5m, 5.5m, 6m, 6.75m, lengths only						34.12				A
6101	Rail, Black and Matt White 6m lengths only						33.79				A
6101	Rail, Gunmetal, Antique Bronze, Bronze, Anodic Grey, Charcoal, Slate Grey 6m lengths only , Rail, chrome, 4m lengths only						49.52				A
6103	Rail, Silver, White, Matt White, Ecru, Black in 6 metre lengths only						35.36				A
6103	Rail, Antique Bronze, Anodic Grey, Bronze, Charcoal, Gunmetal, Slate Grey, Sand, Ochre, Taupe, Chrome (Chrome 4m lengths max)						51.77				A
6106	Rail, White, Matt White Ecru Black in 6 metre lengths only						46.40				A
6106	Rail, Antique Bronze, Anodic Grey, Bronze, Charcoal, Gunmetal, Slate Grey, Sand, Ochre, Taupe, Chrome (Chrome 4m lengths max)						63.78				A
6110	Dustcover, white						3.79				A
6122	Endstop			336.62							A
6124	Twist fixing plate	5.99									A
6124	Twist fixing plate, black (Black available from 1st April 2023)	9.59									A
6137	Ceiling fix plate, single, silver	8.33									A
6137	Ceiling fix plate, single, white	9.14									A
6138	Ceiling fix plate, double, silver	9.28									A
6138	Ceiling fix plate, double, white	10.19									A
6141	Insert		29.30	269.95							A
6143	Glider			21.51	1000.00	200.89					A
6146	Hook			22.71	12.00	3.36					A
6147	Glider hook				20.00	14.52					A
6147	Glider hook				500.00	290.59					A
6147	Glider hook				8000.00	3892.97					A
6148	Glider (yellow)				1000.00	323.16					A
6149	Lead glider (blue)			79.44							A
6151	Ceiling support 3mm, Antique Bronze, Bronze, Anodic Grey, Black, Bronze, Charcoal, Ecru, Gunmetal, Slate Grey, Silver, Sand, Ochre, Taupe, White, Matt White, Chrome for 30mm Hand	10.35	93.21								A
6152	Ceiling support 9mm, Antique Bronze, Bronze, Anodic Grey, Black, Bronze, Charcoal, Ecru, Gunmetal, Slate Grey, Silver, Sand, Ochre, Taupe, White, Matt White, Chrome for 30mm Cord	20.68	186.43								A
6160	Track insert	19.69									A
6160	Track insert, black (Available from 1st April 2023)	52.87									A
6165	(New code 11663) Intermediate Pulley for 6120, Antique Bronze, Anodic Grey, Black, Bronze, Charcoal, Ecru, Gunmetal, Slate Grey, Sand, Ochre, Taupe, White, Matt White, Chrome	76.34	763.37								A
6173	Connecting Bridge	6.15	58.62								A
6175	Mini hanger, white / silver	31.51									A
6175	Mini hanger, Black, Antique Bronze, Anodic Grey, Bronze, Charcoal, Ecru, Gunmetal, Matt White, Ochre, Slate Grey, Sand, Taupe	41.45	394.74								A
6175	Mini hanger, Chrome	49.32	469.69								A
6187	Dummy ceiling support sleeve, silver	10.35									A
6187	Dummy ceiling support sleeve, white	11.96									A
6190	Hanger rod assembly, complete including 6192 ceiling support and 6191 rod 61 cm (2') silver	36.98									A
6190	Hanger rod assembly, complete including 6192 ceiling support and 6191 rod 61 cm (2') white	40.91									A
6190	Hanger rod assembly, complete including 6192 ceiling support and 6191 rod 61 cm (2') Black (Black available from 1st April 2023)	63.65									A
6190	Hanger rod assembly, complete including 6192 ceiling support and 6191 rod 91 cm (3') silver	42.53									A
6190	Hanger rod assembly, complete including 6192 ceiling support and 6191 rod 91 cm (3') white	45.89									A
6190	Hanger rod assembly, complete including 6192 ceiling support and 6191 rod 91 cm (3') Black (Black available from 1st April 2023)	71.50									A
6191	Hanger tube, silver						18.38				A
6191	Hanger tube, white						20.43				A
6191	Hanger tube, black (Black available from 1st April 2023)						24.52				A
6192B	Ceiling support, 100mm complete with stud 6193 and 2 grub screws, silver	32.80									A
6192B	Ceiling support, 100mm complete with stud 6193 and 2 grub screws, white	35.97									A
6192B	Ceiling support, 100mm complete with stud 6193 and 2 grub screws, black (Black available from 1st April 2023)	43.16									A
6193	Stud for ceiling support	3.37									A
6194	Insert	3.12									A

# Price Index for Rails & Parts

All prices shown  
exclude V.A.T.

Product	Description	Unit Prices				Per Metre Price				Qty
		Each	Per 10	Per 100	Other Qty	Price	1m	100m	Other Lgth	
6197	Hanger joint sleeve, silver	20.93								A
6197	Hanger joint sleeve, white	23.02								A
6199	Internal connecting bridge	14.32								A
6203	Connecting bridge	32.08								C
6209	Clamp	9.53	90.48							C
6214	Adjustable pilot	13.52								C
6224	Nylon clamp	16.45								C
6227	Master runner	13.52								C
6228	Double fixing plate	7.44								C
6243p	Rail White in 6 metre lengths only						13.89			A
6268	Hanger	12.92								A
6269	Connecting bridge for 6293	48.34								A
6283	Roller glider		19.84	188.21						A
6288	Plastic overlap arm, white, black (Black available from 1st April 2023)	4.11	37.07	333.40						A
6290p	Rail, White, in 6m lengths						8.49			A
6293p	Rail, white in 6 metre lengths only						35.72			A
6293p	Rail, white cut to size						39.29			A
6349	Wave curtain tape, white, 50m, 100m rolls only							331.88	50.00	169.97
6349	Wave curtain tape, black, 50m, 100m rolls only (Black available from 1st April 2023)							398.26	50.00	203.96
6354	Pilot runner for set 6119 (System 6120)	7.11	67.61							A
6363	Wave Iron-on hemming tape							236.29		A
6364	Extension arm, white, black (Black available from 1st April 2023)	5.77	51.96							A
6365	Hanger, white, black (Black available from 1st April 2023)	4.81	43.31							A
6366	Draw rod carrier, white, black (Black available from 1st April 2023)	9.11	82.05							A
6367	Master carrier	2.88	25.99							A
6368	Carrier	2.88	25.99							A
6369	Insert for face fixing 6370	5.82								C
6371	Rail, silver in 4 metre, 5 metre and 6 metre lengths only						37.23			C
6371	Rail, silver, cut to size						43.03			C
6376	Connecting bridge	19.38	184.14							C
6377	Endpiece set, grey	46.60	443.74							C
6380p	Rail, white in 6 metre lengths only						21.49			A
6380p	Rail, white cut to size						23.64			A
6381	End cap white for 6380			336.23						A
6398	Clip	1.13	10.17							C
6466	Rail, white, black in 6 metre lengths only (Black available from 1st April 2023)						21.85			A
6466	Rail, white, black cut to size (Black available from 1st April 2023)						24.04			A
6471	Endcover white, black for 6465 (Black available from 1st April 2023)		13.68	130.37						A
6501	V-hanger, silver	86.56			metre drop	32.17				A
6501	V-hanger, white	95.24			metre drop	35.38				A
6503	Wall bracket complete, white, 25mm long with 50mm projection	17.98								A
6503	Wall bracket complete, silver, 25mm long with 50mm projection	16.32								A
6503	Wall bracket complete, white, 50mm long with 50mm projection	23.94								A
6503	Wall bracket complete, silver, 50mm long with 50mm projection	21.14								A
6503	Wall bracket complete, white, 100mm long with 50mm projection	29.68								A
6503	Wall bracket complete, silver, 100mm long with 50mm projection	26.42								A
6503	Wall bracket complete, white, 200mm long with 50mm projection	41.52								A
6503	Wall bracket complete, silver, 200mm long with 50mm projection	37.44								A
6503	Wall bracket complete, white, 50mm long with 100mm projection	35.32								A
6503	Wall bracket complete, silver, 50mm long with 100mm projection	31.46								A
6503	Wall bracket complete, white, 100mm long with 100mm projection	48.94								A
6503	Wall bracket complete, silver, 100mm long with 100mm projection	44.49								A
6503	Wall bracket complete, white, 75mm long with 150mm projection	85.75								A
6503	Wall brackets complete, silver 75mm long with 150mm projection	77.95								A
6512	Connecting bridge, silver	28.64								A
6512	Connecting bridge, white	32.59								A
6512	Connecting bridge, black (Black Available from 1st April 2023)	36.54								A
6514M	T-junction, single, silver	13.22								A
6514M	T-junction, single, white	15.69								A
6519	Silver V-hanger rod						13.01			A
6521	External bridge 6103, silver	83.15								A
6521	External bridge 6103, white	88.61								A
6524A	Diagonal fixing support, silver	53.05								A
6524A	Diagonal fixing support, white	63.71								A
6525A	Double T-junction, silver	18.21								A
6525A	Double T-junction, white	21.06								A
6530	V Hanger, black, 61cm long (Black available from 1st April 2023)	266.10								A
6530	V Hanger, black, 91cm long (Black available from 1st April 2023)	273.95								A
6610	Wall support, white	9.45								A
6610	Wall support, grey,	9.45								A
6610	Wall support, black (Available from 1st April 2023)	20.28								A
6611	Endcover, grey	7.32								A
6611	Endcover, white	8.25								A
6611	Endcover, black (Available from 1st April 2023)	9.90								A
6620	Wall bracket 6103, grey	16.99	153.63							A
6620	Wall bracket 6103, white	16.99	153.63							A
6625A	Fixing sleeve complete for V-hanger/diagonal support, silver	35.17								A
6625A	Fixing sleeve complete for V-hanger/diagonal support, white	39.70								A
6628	V-hanger track insert	26.66								A
6632	Internal connecting bridge 6103	11.20								A
6635	Internal connecting bridge	23.23								A
6639	Track insert	3.32								A

# Price Index for Rails & Parts

All prices shown  
exclude V.A.T.

Product	Description	Unit Prices					Per Metre Price				Qty
		Each	Per 10	Per 100	Other Qty	Price	1m	100m	Other Lgth	Price	
6655	Wall Support	38.45									A
6663	Wall brackets connector plate complete	46.49									A
6666	Safety connecting bridge	59.31									A
6669	Dustcap for 6650 (2.5mtr length)							1m	6.98		A
6671	Washer insert for countersunk screw	2.32									A
6672	Cover for 6671	2.93									A
6675	Safety Device	48.56									A
6677	V-Hanger safety device	74.45									A
6679	Acrylic disc for use with 6655	9.03									A
6739	Machine screw M4 6mm/ 1/4"			19.05							A
6748	Machine screw M4 8mm/ 5/16"			26.55							A
6770	Locking pin	1.88									A
6771	Vine eye	2.17									A
6784	Machine screw for 6639			19.76							A
6789	Grub screw	0.32									A
6794	Screw for 5600 Direct Fix	0.06		5.44							C
6798	Machine screw M4 12mm/ 1/2"			27.84							A
6821	Rail, white in 6 metre lengths only						21.19				A
6821	Rail, white cut to size						23.31				A
6822	Rail, white in 6 metre lengths only						11.85				A
6822	Rail, white cut to size						13.04				A
6823	Endcover with screw white for 6820	7.34	69.89	665.62							A
6824	Endcover with screw white for 1020	6.96	66.29	631.31							A
6835A	Round head No. 4 screw 12mm/ 1/2"			10.66							A
6835B	Round head No. 4 screw 25mm/ 1"			18.39							A
6944	Screw Countersunk Head M3 x 8			16.14							A
6938	Screw Countersunk Head M5 x 10			24.13							A
7002	Rail protector	6.91									A
8013	Bottom bar clip (25mm)	1.67	15.23								C
8235	Wire base short, white, grey, black (Black and Grey available from 1st April 2023)	4.38									C
8236	Wire base long, white, grey, black (Black and Grey available from 1st April 2023)	5.85									C
8237	Wire holder, white, grey, black (Black and Grey available from 1st April 2023)	5.95									C
8249A	Locking ring	0.77									C
8920	Universal bracket for 8910	8.71									C
9060	Motor, white, grey	1086.26									C
9060	Motor, black (Available from 1st April 2023)	1303.51									C
9060	Motor, white, grey, slow motor	1086.26									C
9063	Radio module set, white, grey (compatible with 9940)	203.33									C
9063	Radio module set, black (compatible with 9940) (Black available from 1st April 2023)	243.99									C
9068	Single channel receiver	469.65									C
9090	Motor for 2650/2950	858.25									C
9091	Motor with receiver for 2650/2950	975.65									C
9916	In line connector for electric Roller blinds	77.02									C
9944	Single channel receiver, non latching	360.12									C
9945	Single channel receiver, latching	325.61									C
9947	Control unit DC 24V	212.79									C
9953	Volt free switching module	231.02									C
9959	Surface relay socket	178.07									C
9960	Move server set (includes 1 x transmitter stick)	1188.68									C
9961	Move transmitter stick	434.87									C
10040	Power supply set for 2650, 2950	149.71									C
10048	Power cable with plug for 5090, 2650 and 2950	8.75									C
10075	Lead weight						4.19				A
10076	Fabric weight white	10.33									A
10076/1	Fabric weight s/steel	9.82									A
10122	Profile cut to size, white, (for System 2700, 2 channel)						43.56				C
10123	Profile cut to size, white, (for System 2700, 3 channel)						70.29				C
10124	Profile cut to size, white, (for System 2700, 4 channel)						74.84				C
10125	Profile cut to size, white, (for System 2700, 5 channel)						81.29				C
10132	Profile cut to size, white (for System 2730, 2 channel)						34.35				C
10133	Profile cut to size, white (for System 2730, 3 channel)						53.93				C
10134	Profile cut to size, white (for System 2730, 4 channel)						73.49				C
10135	Profile cut to size, white (for System 2730, 5 channel)						93.07				C
10136	Top fix bracket for 2700, 2 channel profile only	4.25	40.42								C
10137	Top fix bracket for 2700, 3, 4 and 5 channel profiles	4.96	47.17								C
10139	Screw	0.10									A
10140	Angle with screw	1.78									C
10142	Cover for 2 channel 2700 profile	2.62									C
10143	Cover for 3 channel 2700 profile	2.63									C
10144	Cover for 4 channel 2700 profile	2.69									C
10145	Cover for 5 channel 2700 profile	3.76									C
10146	Angle with screw	1.78									C
10148	Eyelet with screw	2.35									C
10150	Pilot runner with screw for 2700	4.68									C
10153	cord guide for 3 channel 2700 profile	9.50									C
10154	cord guide for 4 channel 2700 profile	9.59									C
10155	cord guide for 5 channel 2700 profile	11.29									C
10156	End stop with screw for 2700	3.71									C
10157	Wedge, white, black for 2700, 6870 and 3870 recess profiles (Black Available from 1st April 2023)	2.51	23.81								A
10172	Recess profile, 2 channel, (for System 2700)						38.24				C

# Price Index for Rails & Parts

All prices shown  
exclude V.A.T.

Product	Description	Unit Prices					Per Metre Price				Qty
		Each	Per 10	Per 100	Other Qty	Price	1m	100m	Other Lgth	Price	
10173	Recess profile, 3 channel, (for System 2700)						38.24				C
10174	Recess profile, 4 channel, (for System 2700)						38.24				C
10175	Recess profile, 5 channel, (for System 2700)						38.24				C
10177	Connecting bridge for 2730	6.83									C
10180	Carrier assembled, flexible, (for system 2730)						49.33				C
10200	Roller for 2700 carrier	1.66									C
10230	Carrier assembled, white, (for system 2700)						45.94				C
10234	Glass weight bar 16mm	1.90									C
10252	2700 carrier end cover left	0.93									C
10253	2700 carrier end cover right	0.93									C
10269	Face fix bracket, 60mm, white, (for System 2730)	5.31	50.57								C
10270	Face fix bracket, 80mm, white, (for System 2730)	5.98	56.76								C
10271	Face fix bracket, 100mm, white, (for System 2730)	6.63	62.96								C
10272	Face fix bracket, 60mm, white, (for System 2730)	7.27	69.16								C
10281	Slot nut (for System 2730)		19.58								C
10300	Single channel hand held remote	264.74									C
10302	5 + 1 channel hand held remote	264.74									C
10303	10 + 2 + 1 channel hand held remote	322.67									C
10399	Design Fascia for 2730, white				per system	4.72	28.91				C
10430	Draw rod 50cm aluminium	11.19									A
10430	Draw rod 50cm white	12.14									A
10430	Draw rod 50cm black (Available from 1st April 2023)	14.57									A
10431	Draw rod 75cm aluminium	13.03									A
10431	Draw rod 75cm white	14.53									A
10431	Draw rod 75cm black (Available from 1st April 2023)	17.44									A
10432	Draw rod 100cm aluminium	14.76									A
10432	Draw rod 100cm white	16.60									A
10432	Draw rod 100cm black (Available from 1st April 2023)	19.92									A
10433	Draw rod 125cm aluminium	16.08									A
10433	Draw rod 125cm white	18.21									A
10433	Draw rod 125cm black (Available from 1st April 2023)	21.85									A
10434	Draw rod 150cm aluminium	17.26									A
10434	Draw rod 150cm white	19.66									A
10434	Draw rod 150cm black (Available from 1st April 2023)	23.59									A
10530	Chain for 4910 roller blind								150m	440.47	A
10530BR	Brass chain for 4910 roller blind								125m	387.45	A
10534	Continuous headrail profile for 4900, 4910, 4960 silver, white (per m width)						22.91				A
10539	Optional click bracket for fixing continuous headrail 10534	5.45									C
10632	Intermediate bracket cover for 4900, 4910, 4960 white, grey, black (Grey and Black available from 1st April 2023)	6.52									C
10633	Rectangular bottom bar for 4900, 4910, 4960 silver, white (per m width) (To be discontinued on the 1st April 2023)	14.46									C
10634	Oval bottom bar for 4900, 4910, 4960 silver, white (per m width) (To be discontinued on the 1st April 2023)	14.46									C
10635	End cover for rectangular bottom bar 10633 silver, white (To be discontinued on the 1st April 2023)	1.59									C
10637	End cover for oval bottom bar 10634 silver, white (To be discontinued on the 1st April 2023)	1.59									C
10639	End cover for round bottom bar 4221 silver, white (To be discontinued on the 1st April 2023)	1.21									C
10645	Pull grip set	15.38									C
10707	Cushion, white, grey, black 4900/4910 (Black available from 1st April 2023)	1.90									C
10709	Chain stop	0.97									C
10711	Screw for 6243 Profile	0.41									A
10731	Cord retainer, white, black (Black available as of 1st April 2023)	0.49									E
10760	Round Bottom weight bar, white, grey, silver, black (Available from 1st April 2023)						22.94				C
10761	End cover for round bottom bar 10760 white, grey, black (Available from 1st April 2023)	2.64									C
10770	Square bottom weight bar, white, silver, grey, black (per m width) (Available from 1st April 2023)						24.00				C
10771	End cover for square bottom bar 10770, white, grey, black (Available from 1st April 2023)	2.76									C
10804	15 + 5 + 1 channel hand held-remote.	322.66									C
10815	Cover, white, grey, black (Black available from 1st April 2023)	1.79									A
10816	Motor cover, white, grey, black (Black available from 1st April 2023)	1.36									C
10817	Motor case holder, white, grey, black (Black available from 1st April 2023)	9.45									C
10819	Belt return set, white, grey, black (Black available from 1st April 2023)	15.09									C
10820	Overlap arm, straight, black (Black available from 1st April 2023)	5.71									C
10821	Overlap arm, bent, white, black (Black available from 1st April 2023)	6.12									C
10821L	Long overlap arm, bent	48.09									C
10822	Master carrier set, white, black (Black available from 1st April 2023)	6.53									C
10823	Belt connector arm	2.10									A
10824	Belt connector pin	2.10									A
10825	Drive belt								644.77		A
10826	Overlap support set, white, black (Black available from 1st April 2023)	7.21									C
10831	Connecting bridge 5600	15.84									C
10836	Mask pair stack, white, black (Black available from 1st April 2023)	2.02									A
10837	Pilot runner arm, white, black (Black available from 1st April 2023)	2.72									C
10838	Pilot runner set, white, black (Black available from 1st April 2023)	30.72									C
10840	2C Roller Glider, white, black (Black available from 1st April 2023)	3.40	33.31	311.32							C
10844	Wave endstop (motor), white, grey, black (Black available from 1st April 2023)	1.90									C
10845	Wave master carrier, white, black single stack (80mm) (Black available from 1st April 2023)	16.99									C

## Price Index for Rails &amp; Parts

All prices shown  
exclude V.A.T.

Product	Description	Unit Prices					Per Metre Price				Qty
		Each	Per 10	Per 100	Other Qty	Price	1m	100m	Other Lgth	Price	
10850	Rail, white, black, silver 6 metre lengths only (Black available from 1st April 2023)						20.88				C
10850	Rail, white, black, silver cut to size (Black available from 1st April 2023)						22.97				C
10852	Wave roller glider cord (80mm), white, black 6.5mm channel (Black available from 1st April 2023)								57m	3614.88	C
10854	Wave overlap support arm, white, black (Black available from 1st April 2023)	2.77									A
10856	Wave end stop (return end), white, grey, black (Black available from 1st April 2023)	3.06									C
10862	Recess profile, white, black for 5600, white, 6 metre lengths only (Black Available from 1st April 2023)						26.50				C
10862	Recess profile, white, black for 5600, white, cut to size (Black Available from 1st April 2023)						29.15				C
10863	Recess mask, motor, white, black (Black Available from 1st April 2023)	5.23									C
10864	Recess mask, belt return, white, black (Black Available from 1st April 2023)	4.55									C
10865	Mounting support plate	2.24									C
10867	M4 X 16 Pan Head Screw for 5100	0.09									A
10869	Wave roller glider cord (60mm), white, black, 6.5mm channel (Black available from 1st April 2023)								43m	3454.80	C
10886	Wave overlap arm, pilot runner set, white, black (Black available from 1st April 2023)	8.56									C
10887	Wave overlap arm set, white, black (Black available from 1st April 2023)	8.77									C
10905	Wave glider cord, white (80mm), 6.5mm channel								50m	1775.07	A
10906	Wave glider cord, white (60mm), 6.5mm channel								50m	2129.74	A
10924	Wave glider support, white, black (Black available from 1st April 2023)	2.20									A
10923	Pan head screw M4 x 12 for 3970			53.87							C
10925	Rail, white 6 metre lengths only (System 5100)								6m	151.69	A
10925	Rail, white, cut to size (System 5100)						26.54				A
10926	Clamp	4.67	44.50	423.79							A
10927	Hook for 5100	2.59									A
10931	Roller Glider for 10925	0.48									A
10933	Belt return & Motor Holder Set	8.96									A
10936	Overlap Arm Set	13.79									A
10940	Belt Return for 5100	7.52									A
10943	Connecting bridge for 5100	17.85									A
10945	Endstop for 5100	1.94									A
10946	1 Channel Transmitter White	60.66									A
10947	2+1 Channel Transmitter White	74.43									A
10948	6+1 Channel Transmitter White	74.43									A
10949	1 Channel Wall Transmitter White	50.31									A
10950	2+1 Channel Wall Transmitter White	74.43									A
10951	5+1 Channel Wall Transmitter White	74.43									A
11116	Smart Fix Bracket Cover with Magnet in Silver and White	5.26	50.11	477.20							A
11116	Smart Fix Bracket Cover with Magnet in Antique Bronze, Anodic Grey, Black, Bronze, Charcoal, Ecu, Gunmetal, Slate Grey, Sand, Ochre, Taupe, Matt White	6.20	59.04	562.28							A
11116	Smart Fix Bracket Cover with Magnet in Chrome	12.15	115.75	1102.37							A
11118	Smart Fix 60mm Bracket in White and Silver (Set equivalent 11200)	4.44	40.86	388.25							A
11118	Smart Fix 60mm Bracket in Anodic Grey, Antique Bronze, Black, Charcoal, Matt White - Available from 1st April 2023 (Set equivalent 11200)	4.88	44.95	427.07							A
11119	Smart Fix 80mm Bracket in White and Silver (Set equivalent 11201)	5.09	49.68	471.91							A
11119	Smart Fix 80mm Bracket in Anodic Grey, Antique Bronze, Black, Charcoal, Matt White - Available from 1st April 2023 (Set equivalent 11201)	5.60	54.65	519.10							A
11120	Smart Fix 100mm Bracket in White and Silver (Set equivalent 11202)	5.23	50.32	478.07							A
11120	Smart Fix 100mm Bracket in Anodic Grey, Antique Bronze, Black, Charcoal, Matt White - Available from 1st April 2023 (Set equivalent 11202)	5.75	55.35	525.88							A
11121	Smart Fix 120mm Bracket in White and Silver (Set equivalent 11203)	8.59	81.74	778.07							A
11121	Smart Fix 120mm Bracket in Anodic Grey, Antique Bronze, Black, Charcoal, Matt White - Available from 1st April 2023 (Set equivalent 11203)	9.45	89.91	855.88							A
11122	Smart Fix 150mm Bracket in White and Silver (Set equivalent 11204)	8.79	83.54	795.33							A
11122	Smart Fix 150mm Bracket in Anodic Grey, Antique Bronze, Black, Charcoal, Matt White - Available from 1st April 2023 (Set equivalent 11204)	9.67	91.89	874.86							A
11123	Smart Fix 200mm Bracket in White and Silver (Set equivalent 11205)	9.74	92.53	881.03							A
11123	Smart Fix 200mm Bracket in Anodic Grey, Antique Bronze, Black, Charcoal, Matt White - Available from 1st April 2023 (Set equivalent 11205)	10.71	101.78	969.13							A
11124	Smart Fix 60mm Bracket Slotted for Metropole in Silver, Black, White, Matt White, Ecu, Gunmetal, Charcoal, Bronze, Antique Bronze, Anodic Grey, Slate Grey, Ochre, Sand, Taupe (Set equivalent 11206)	5.78	53.64	492.93							A
11124	Smart Fix 60mm Bracket Slotted for Metropole in Chrome (Set equivalent 11206)	9.79	95.56	888.95							A
11125	Smart Fix 80mm Bracket Slotted for Metropole in Silver, Black, White, Matt White, Ecu, Gunmetal, Charcoal, Bronze, Antique Bronze, Anodic Grey, Slate Grey, Ochre, Sand, Taupe (Set equivalent 11207)	6.88	63.77	586.04							A
11125	Smart Fix 80mm Bracket Slotted for Metropole in Chrome (Set equivalent 11207)	10.39	101.56	944.51							A
11126	Smart Fix 100mm Bracket Slotted for Metropole in Silver, Black, White, Matt White, Ecu, Gunmetal, Charcoal, Bronze, Antique Bronze, Anodic Grey, Slate Grey, Ochre, Sand, Taupe (Set equivalent 11208)	8.11	75.03	689.71							A
11126	Smart Fix 100mm Bracket Slotted for Metropole in Chrome (Set equivalent 11208)	13.19	128.88	1198.79							A
11127	(New code 20798) M4 x 10 CSK. Head Screw for 6138P/6141			29.11							A
11128	Smart Fix Adjustable Extension Bracket slotted for Metropole in Silver, Black, White, Matt White, Ecu, Gunmetal, Charcoal, Bronze, Antique Bronze, Anodic Grey, Slate Grey, Ochre, Sand, Taupe (Set equivalent 11209)	10.17	96.85	922.34							A
11128	Smart Fix Adjustable Extension Bracket slotted for Metropole in Chrome (Set equivalent 11209)	21.14	201.33	1917.43							A
11137	Square Smart Fix Bracket Cover with Magnet in Silver and White	6.14	58.52	557.35							A

# Price Index for Rails & Parts

All prices shown  
exclude V.A.T.

Product	Description	Unit Prices				Per Metre Price				Ctgy
		Each	Per 10	Per 100	Other Qty	Price	1m	100m	Other Lgth	
11137	Square Smart Fix Bracket Cover with Magnet in Antique Bronze, Anodic Grey, Black, Bronze, Charcoal, Ecu, Gunmetal, Slate Grey, Sand, Ochre, Taupe, Matt White	7.80	74.32	707.78						A
11137	Square Smart Fix Bracket Cover with Magnet in Chrome	12.32	117.30	1117.16						A
11139	Square Smart Fix 60mm Bracket in White and Silver (Set equivalent 11210)	6.24	59.43	565.98						A
11139	Square Smart Fix 60mm Bracket in Anodic Grey, Antique Bronze, Black, Charcoal, Matt White - Available from 1st April 2023 (Set equivalent 11210)	8.28	78.85	750.95						A
11140	Square Smart Fix 80mm Bracket in White and Silver (Set equivalent 11211)	6.88	65.51	623.94						A
11140	Square Smart Fix 80mm Bracket in Anodic Grey, Antique Bronze, Black, Charcoal, Matt White- Available from 1st April 2023 (Set equivalent 11211)	9.12	86.92	827.88						A
11141	Square Smart Fix 100mm Bracket in White and Silver (Set equivalent 11212)	7.53	71.73	683.12						A
11141	Square Smart Fix 100mm Bracket in Anodic Grey, Antique Bronze, Black, Charcoal, Matt White - Available from 1st April 2023 (Set equivalent 11212)	9.98	95.00	904.83						A
11142	Square Smart Fix 120mm Bracket in White and Silver (Set equivalent 11213)	8.31	79.11	753.41						A
11142	Square Smart Fix 120mm Bracket in Anodic Grey, Antique Bronze, Black, Charcoal, Matt White - Available from 1st April 2023 (Set equivalent 11213)	10.98	104.60	996.21						A
11143	Square Smart Fix 150mm Bracket in White and Silver (Set equivalent 11214)	9.35	89.08	848.35						A
11143	Square Smart Fix 150mm Bracket in Anodic Grey, Antique Bronze, Black, Charcoal, Matt White - Available from 1st April 2023 (Set equivalent 11214)	12.35	117.56	1119.63						A
11144	Square Smart Fix 200mm Bracket in White and Silver (Set equivalent 11215)	10.64	101.38	965.50						A
11144	Square Smart Fix 200mm Bracket in Anodic Grey, Antique Bronze, Black, Charcoal, Matt White - Available from 1st April 2023 (Set equivalent 11215)	14.03	133.55	1271.92						A
11145	Square Smart Fix 60mm Bracket Slotted for Metropole in Silver, Black, White, Matt White, Ecu, Gunmetal, Charcoal, Bronze, Antique Bronze, Anodic Grey, Slate Grey, Ochre, Sand, Taupe (Set equivalent 11216)	7.61	72.50	690.52						A
11145	Square Smart Fix 60mm Bracket Slotted for Metropole in Chrome (Set equivalent 11216)	13.38	127.40	1213.34						A
11146	Square Smart Fix 80mm Bracket Slotted for Metropole in Silver, Black, White, Matt White, Ecu, Gunmetal, Charcoal, Bronze, Antique Bronze, Anodic Grey, Slate Grey, Ochre, Sand, Taupe (Set equivalent 11217)	8.16	77.68	739.84						A
11146	Square Smart Fix 80mm Bracket Slotted for Metropole in Chrome (Set equivalent 11217)	13.87	132.06	1257.73						A
11147	Square Smart Fix 100mm Bracket Slotted for Metropole in Silver, Black, White, Matt White, Ecu, Gunmetal, Charcoal, Bronze, Antique Bronze, Anodic Grey, Slate Grey, Ochre, Sand, Taupe (Set equivalent 11218)	8.92	84.93	808.90						A
11147	Square Smart Fix 100mm Bracket Slotted for Metropole in Chrome (Set equivalent 11218)	14.36	136.72	1302.13						A
11154	Universal Smart Fix 120mm in White and Silver	20.69	197.06	1876.74						A
11154	Universal Smart Fix 120mm in Black - Available from 1st April 2023	23.79	226.61	2158.25						A
11155	Universal Smart Fix 150mm in White and Silver	21.03	200.29	1907.56						A
11155	Universal Smart Fix 150mm in Black - Available from 1st April 2023	24.18	230.34	2193.69						A
11156	Universal Smart Fix 200mm in White and Silver	21.49	204.70	1949.49						A
11156	Universal Smart Fix 200mm in Black - Available from 1st April 2023	24.71	235.41	2241.91						A
11190	Rail, white, black and silver in 6 meter lengths (Black available from 1st April 2023)						20.95			A
11190	Rail, white, black and silver cut to size (Black available from 1st April 2023)						23.05			A
11190	Rail, matt white, anodic grey, antique bronze and charcoal in 6m lengths						37.40			A
11190	Rail, matt white, anodic grey, antique bronze and charcoal cut to size						41.13			A
11200	Smart Fix 60mm Bracket Set in White and Silver (made up of 11118 + 11116)	7.20	68.54	652.78						A
11200	Smart Fix 60mm Bracket Set in Anodic Grey, Antique Bronze, Black, Charcoal, Matt White - Available from 1st April 2023 (made up of 11118 + 11116)	9.45	90.09	858.00						A
11201	Smart Fix 80mm Bracket Set in White and Silver (made up of 11119 + 11116)	8.12	77.33	736.44						A
11201	Smart Fix 80mm Bracket Set in Anodic Grey, Antique Bronze, Black, Charcoal, Matt White - Available from 1st April 2023 (made up of 11119 + 11116)	9.86	93.87	894.00						A
11202	Smart Fix 100mm Bracket Set in White and Silver (made up of 11120 + 11116)	8.19	77.97	742.61						A
11202	Smart Fix 100mm Bracket Set in Anodic Grey, Antique Bronze, Black, Charcoal, Matt White - Available from 1st April 2023 (made up of 11120 + 11116)	10.65	101.43	966.00						A
11203	Smart Fix 200mm Bracket Set in White and Silver (made up of 11121 + 11116)	12.50	119.09	1134.22						A
11203	Smart Fix 120mm Bracket Set in Anodic Grey, Antique Bronze, Black, Charcoal, Matt white- Available from 1st April (made up of 11121 + 11116)	13.75	131.00	1247.64						A
11204	Smart Fix 150mm Bracket Set in White and Silver (made up of 11122 + 11116)	12.70	120.91	1151.48						A
11204	Smart Fix 150mm Bracket Set in Anodic Grey, Antique Bronze, Black, Charcoal, Matt White- Available from 1st April 2023 (made up of 11122 + 11116)	13.97	133.00	1266.63						A
11205	Smart Fix 200mm Bracket Set in White and Silver (made up of 11123 + 11116)	13.64	129.90	1237.18						A
11205	Smart Fix 200mm Bracket Set in Anodic Grey, Antique Bronze, Black, Charcoal, Matt White - Available from 1st April 2023 (made up of 11123 + 11116)	15.00	142.89	1360.90						A
11206	Smart Fix 60mm Bracket Slotted for Metropole Bracket Set in Black, Silver, White, Matt White, Ecu, Gunmetal, Charcoal, Bronze, Antique Bronze, Anodic Grey, Slate Grey, Ochre, Sand, Taupe (made up of 11124 + 11116)	8.35	79.53	757.46						A

# Price Index for Rails & Parts

All prices shown  
exclude V.A.T.

Product	Description	Unit Prices					Per Metre Price				Qty
		Each	Per 10	Per 100	Other Qty	Price	1m	100m	Other Lgth	Price	
11206	Smart Fix 60mm Bracket Slotted for Metropole Bracket Set in Chrome (made up of 11124 + 11116)	15.31	145.83	1388.87							A
11207	Smart Fix 80mm Bracket Slotted for Metropole Bracket Set in Black, Silver, White, Matt White, Ecu, Gunmetal, Charcoal, Bronze, Antique Bronze, Anodic Grey, Slate Grey, Ochre, Sand, Taupe (made up of 11125 + 11116)	9.38	89.31	850.57							A
11207	Smart Fix 80mm Bracket Slotted for Metropole Bracket Set in Chrome (made up of 11125 + 11116)	15.92	151.67	1444.43							A
11208	Smart Fix 100mm Bracket Slotted for Metropole Bracket Set in Black, Silver, White, Matt White, Ecu, Gunmetal, Charcoal, Bronze, Antique Bronze, Anodic Grey, Slate Grey, Ochre, Sand, Taupe (made up of 11126 + 11116)	10.52	100.20	954.24							A
11208	Smart Fix 100mm Bracket Slotted for Metropole Bracket Set in Chrome (made up of 11126 + 11116)	18.73	178.37	1698.72							A
11209	Smart Fix Adjustable Metropole Bracket Set in Black, Silver, White, Matt White, Ecu, Gunmetal, Charcoal, Bronze, Antique Bronze, Anodic Grey, Slate Grey, Ochre, Sand, Taupe (made up of 11128 + 11116)	13.09	124.62	1186.87							A
11209	Smart Fix Adjustable Metropole Bracket Set in Chrome (made up of 11128 + 11116)	26.65	253.84	2417.48							A
11210	Square Smart Fix 60mm Bracket Set in White and Silver (made up of 11139 + 11137)	12.37	117.82	1122.10							A
11210	Square Smart Fix 60mm Bracket Set in Anodic Grey, Antique Bronze, Black, Charcoal, Matt White - Available from 1st April 2023 (made up of 11139 + 11137)	16.08	153.17	1458.73							A
11211	Square Smart Fix 80mm Bracket Set in White and Silver (made up of 11140 + 11137)	13.02	124.03	1181.28							A
11211	Square Smart Fix 80mm Bracket Set in Anodic Grey, Antique Bronze, Black, Charcoal, Matt White - Available from 1st April 2023 (made up of 11140 + 11137)	16.92	161.24	1535.66							A
11212	Square Smart Fix 100mm Bracket Set in White and Silver (made up of 11141 + 11137)	13.68	130.25	1240.47							A
11212	Square Smart Fix 100mm Bracket Set in Anodic Grey, Antique Bronze, Black, Charcoal, Matt White - Available from 1st April 2023 (made up of 11141 + 11137)	17.78	169.32	1612.61							A
11213	Square Smart Fix 120mm Bracket Set in White and Silver (made up of 11142 + 11137)	14.45	137.63	1310.76							A
11213	Square Smart Fix 120mm Bracket Set in Anodic Grey, Antique Bronze, Black, Charcoal, Matt White - Available from 1st April 2023 (made up of 11142 + 11137)	18.78	151.39	1703.99							A
11214	Square Smart Fix 150mm Bracket Set in White and Silver (made up of 11143 + 11137)	15.50	147.60	1405.70							A
11214	Square Smart Fix 150mm Bracket Set in Anodic Grey, Antique Bronze, Black, Charcoal, Matt White - Available from 1st April 2023 (made up of 11143 + 11137)	20.15	191.88	1827.41							A
11215	Square Smart Fix 200mm Bracket Set in White and Silver (made up of 11144 + 11137)	16.79	159.90	1522.85							A
11215	Square Smart Fix 200mm Bracket Set in Anodic Grey, Antique Bronze, Black, Charcoal, Matt White - Available from 1st April 2023 (made up of 11144 + 11137)	21.83	207.87	1979.7							A
11216	Square Smart Fix 60mm Bracket Slotted for Metropole Bracket Set in Silver and White (made up of 11145 + 11137)	13.76	131.03	1247.87							A
11216	Square Smart Fix 60mm Bracket Slotted for Metropole Bracket Set in Black, Matt White, Ecu, Gunmetal, Charcoal, Bronze, Antique Bronze, Anodic Grey, Slate Grey, Ochre, Sand, Taupe (made up of 11145 + 11137)	15.42	146.82	1398.31							A
11216	Square Smart Fix 60mm Bracket Slotted for Metropole Bracket Set in Chrome (made up of 11145 + 11137)	25.69	244.70	2330.51							A
11217	Square Smart Fix 80mm Bracket Slotted for Metropole Bracket Set in Silver and White (made up of 11146 + 11137)	14.30	136.21	1297.19							A
11217	Square Smart Fix 80mm Bracket Slotted for Metropole Bracket Set in Black, Matt White, Ecu, Gunmetal, Charcoal, Bronze, Antique Bronze, Anodic Grey, Slate Grey, Ochre, Sand, Taupe (made up of 11146 + 11137)	15.96	152.00	1447.63							A
11217	Square Smart Fix 80mm Bracket Slotted for Metropole Bracket Set in Chrome (made up of 11146 + 11137)	26.18	249.36	2374.90							A
11218	Square Smart Fix 100mm Bracket Slotted for Metropole Bracket Set in Silver and White (made up of 11147 + 11137)	15.06	143.46	1366.25							A
11218	Square Smart Fix 100mm Bracket Slotted for Metropole Bracket Set in Black, Matt White, Ecu, Gunmetal, Charcoal, Bronze, Antique Bronze, Anodic Grey, Slate Grey, Ochre, Sand, Taupe (made up of 11147 + 11137)	16.72	159.25	1516.68							A
11218	Square Smart Fix 100mm Bracket Slotted for Metropole Bracket Set in Chrome (made up of 11147 + 11137)	26.67	254.03	2419.29							A
11230	Recess profile white, black for 6870 and 3870, in 6 meter lengths (Black available from 1st April 2023)						20.40				A
11230	Recess profile white, black for 6870 and 3870, cut to size (Black available from 1st April 2023)						22.44				A
11231	Recess profile, white, black for 6465, in 6 meter lengths (Black available from 1st April 2023)						14.70				A
11231	Recess profile, white, black for 6465, cut to size (Black available from 1st April 2023)						16.17				A
11233	Endcover with screw, white, black silver for 6870 (Black available from 1st April 2023)	7.48	71.28	678.79							A
11233	Endcover with screw, matt white, anodic grey, antique bronze and charcoal	8.87	84.47	804.49							A
11235	Endcover with screw white, black or silver for 6970 (Black available from 1st April 2023)	10.08	96.04	914.63							A
11236	Clip			303.05							A
11237	Recess Wedge, white, black (Black available from 1st April 2023)	0.69									A
11238	Recess Mask, white, black for 3870 and 6870 (Black Available from 1st April 2023)	3.64									A
11239	Recess Mask, white, black (Black available from 1st April 2023)	1.86									A
11260	Gateway	885.90									C
11261	Gateway KNX	1065.47									C
11262	Expansion unit	861.95									C
11263	Power supply 24V DC 2 ampere DIN rail	82.47									C
11264	Power supply 24V DC 3.8 ampere DIN rail	100.70									C
11265	Power supply 24V DC 5 ampere DIN rail	106.58									C

# Price Index for Rails & Parts

All prices shown  
exclude V.A.T.

Product	Description	Unit Prices				Per Metre Price				Ctgy
		Each	Per 10	Per 100	Other Qty	Price	1m	100m	Other Lgth	
11266	Power supply 24V DC 10 ampere DIN rail	196.58								C
11270	RS 485 module set white	233.45								C
11281	Cabinet up to 8 shading device unit including circuit breaker protection	2673.00								C
11282	Cabinet up to 24 shading device unit including circuit breaker protection	3447.00								C
11283	Cabinet up to 56 shading device unit including circuit breaker protection	6534.00								C
11285	Guide set white, black and silver for 3870 (Black available from 1st April 2023)	32.81	312.46							A
11285	Guide set matt white, anodic grey, antique bronze and charcoal	43.83	417.45							A
11289	Cable with plug	40.55								C
11295	Endstop, silver	0.83	7.88							A
11295	Endstop, white	1.06	10.07							A
11295	Endstop, black	1.20	11.40							A
11301	2C glider in strip form, white, black (Black available from 1st April 2023)				1000	304.56				A
11302	Wave 2C glider-cord, 80mm pitch, white, black 50mm rolls only (Black available from 1st April 2023)							50m	770.71	A
11303	Wave 2C glider-cord, 60mm pitch, white, black 50mm rolls only (Black available from 1st April 2023)							50m	1012.35	A
11314	Master carrier for 3970	13.68	130.37							C
11315	Guide set white for 3970	57.43								C
11318	4-Pin connector for 5600 SMART module	11.13								C
11319	4-Pin connector for 5600 SMART motor (motor side)	11.13								C
11320	4-Pin connector for 5600 SMART motor (room side)	16.70								C
11325	6 - Pin connector for Gateway and Expansion unit	14.72								C
11326	Antenna Cable 40-Series	2.64								C
11327	Dry Contact Cable 40-Series / 50 Series	5.20								C
11335	Endstop, silver	1.17		105.34						A
11335	Endstop, black	1.39		126.69						A
11335	Endstop, white	1.26		115.07						A
11411	Radio module set, white, grey (compatible with 0450)	203.32								C
11412	Power supply 24V DC	71.58								C
11425	Power supply set 24v DC UL, 4.0A for 2950	152.78								C
11429	Timer White	146.82								A
11465	Spring Stop for SG 6970	2.49								C
11472	Square Smart Fix Adjustable Metropole Bracket Set in White or Silver (made up of 11483 + 11137)	14.90	142.02	1352.40						A
11472	Square Smart Fix Adjustable Metropole Bracket Set in Black, Matt White, Ecru, Gunmetal, Charcoal, Bronze, Antique Bronze, Anodic Grey, Slate Grey, Ochre, Sand, Taupe (made up of 11483 + 11137)	16.57	157.81	1502.84						A
11472	Square Smart Fix Adjustable Metropole Bracket Set in Chrome (made up of 11483 + 11137)	33.11	315.61	3005.68						A
11480	1 Channel Wall Swtich	135.92								C
11483	Square Smart Fix Adjustable Extension Bracket slotted for Metropole in Silver, Black, White, Matt White, Ecru, Gunmetal, Charcoal, Bronze, Antique Bronze, Anodic Grey, Slate Grey, Ochre, Sand, Taupe (Set equivalent 11472)	8.76	83.49	795.05						A
11483	Square Smart Fix Adjustable Extension Bracket slotted for Metropole in Chrome (Set equivalent 11472)	20.80	198.31	1888.52						A
11490	5 Channel Wall Switch	249.31								C
11601	(Old code 20351) Flush Endcap, 36mm, Silver, Black, White, Matt White, Gunmetal, Chrome, Antique bronze, Slate Grey, Charcoal, Anodic Grey, Bronze	9.77	95.79							A
11602	(Old code 20339) Flush Endcap, 23mm, Silver, Charcoal, Ecru, White, Matt White Gunmetal, Chrome	11.29	110.26							A
11603	(Old code 20346) Flush Endcap, 30mm, Silver, Black, Gunmetal, White, Matt White, Charcoal, Ecru, Bronze, Antique Bronze, Anodic Grey, Slate Grey, Ochre, Sand, Taupe, Chrome	9.63	91.33							A
11605	(Old code 20350) Flush Endcap, 50mm, Silver, White, Matt White, Ecru, Black	29.99	293.90							A
11605	(Old code 20350) Flush Endcap, 50mm, Antique Bronze, Anodic Grey, Slate Grey, Taupe, Bronze	30.73	301.09							A
11606	(Old code 1003) Rail, 23mm, Silver, White, Matt White, Ecru in 6 metre lengths only						24.11			A
11606	(Old code 1003) Rail, 23mm, Gunmetal, Charcoal in 6 metre lengths only Chrome (4 metre lengths only)						32.97			A
11607	(Old code 20701) Corded profile, 50mm, Black, Ecru, White, Matt White						84.85			A
11607	(Old code 20701) Corded profile, 50mm, Antique Bronze, Bronze, Anodic Grey, Slate Grey, Taupe, Bronze						98.35			A
11609	(Old code 20700) Profile, 50mm, for 7620 Black, Ecru, Silver, White, Matt White						53.68			A
11609	(Old code 20700) Profile, 50mm, for 7620 Antique Bronze, Anodic Grey, Slate Grey, Taupe						72.75			A
11611	(Old code 20710) Stud endcap for 36mm, Antique Bronze, Anodic Grey, Black, Gunmetal, Charcoal, Silver, Slate Grey, White, Matt White, Chrome, Bronze (Avilable from 1st April 2022)	9.76	92.84	879.45						A
11621	(Old code 20706) Stud endcap for 23mm, Ecru, Gunmetal, Charcoal, Silver, White, Matt White, Chrome	11.28	110.27	1025.70						A
11622	Design End cap for 23mm, White, Matt White, Ecru, Gunmetal and Charcoal	15.42	146.92							A
11623	(Old code 20628) Groove cylinder finial only for 23mm, White, Matt White, Ecru, Gunmetal and Charcoal - set equivalent 11723	25.65	244.22							A
11624	(Old code 20329) Glass Ball finial only clear for 23mm - set equivalent 11724	57.94	501.97							A
11626	Ball end finial only for 23mm, White, Matt White, Ecru, Gunmetal and Charcoal - set equivalent 11726	42.15	401.32							A
11627	Spear finial only 23mm, White, Matt White, Ecru, Gunmetal and Charcoal - set equivalent 11727	27.45	261.40							A
11628	Ellipse finial only 23mm, White, Matt White, Ecru, Gunmetal and Charcoal - set equivalent 11728	17.84	169.81							A
11629	Taper finial only 23mm, White, Matt White, Ecru, Gunmetal and Charcoal - set equivalent 11729	11.63	110.66							A

# Price Index for Rails & Parts

All prices shown  
exclude V.A.T.

Product	Description	Unit Prices					Per Metre Price				Qty
		Each	Per 10	Per 100	Other Qty	Price	1m	100m	Other Lgth	Price	
11631	(Old code 20707) Stud endcap for 30mm, Antique Bronze, Anodic Grey, Black, Bronze, Charcoal, Ecu, Gunmetal, Slate Grey, Silver, Sand, Ochre, Taupe, White, Matt White, Chrome	9.63	91.33	867.66							A
11632	(Old code 20873) Design end cap for 30mm, Antique Bronze, Anodic Grey, Black, Bronze, Charcoal, Ecu, Gunmetal, Slate Grey, Sand, Ochre, Taupe, White and Matt White	21.28									A
11633	(Old code 20629) Groove cylinder finial only for 30mm - set equivalent 11733 Cord, 11743 Hand	31.60	300.83								A
11634	(Old code 20331) Glass Ball finial only for 30mm, clear - equivalent set 11734 Cord, 11744 Hand	61.32	531.04								A
11636	(Old code 20556) Ball end finial only 30mm, Black, Gunmetal, White, Matt White, Charcoal, Ecu, Bronze, Antique Bronze, Anodic Grey, Slate Grey, Ochre, Sand and Taupe 30mm poles - set equivalent 11736 Cord, 11746 Hand	45.62	434.44								A
11637	(Old code 20719) Spear finial only 30mm, Antique Bronze, Anodic Grey, Black, Bronze, Charcoal, Ecu, Gunmetal, Slate Grey, Sand, Ochre, Taupe, White, Matt White, Chrome - set equivalent 11737 Cord, 11747 Hand	44.44									A
11638	Ellipse finial only, 30mm, Black, White, Matt White, Ecu, Ochre, Gunmetal, Bronze, Antique Bronze, Sand, Taupe, Anodic Grey, Charcoal and Slate Grey - set equivalent 11738 Cord, 11748 Hand	25.85	246.13								A
11639	Taper finial only, 30mm, Black, White, Matt White, Ecu, Ochre, Gunmetal, Bronze, Antique Bronze, Sand, Taupe, Anodic Grey, Charcoal and Slate Grey - set equivalent 11739 Cord, 11749 Hand	13.23	125.93								A
11651	(Old code 20714) Stud endcap for 50mm, Black, Ecu, Silver, White, Matt White	29.99									A
11651	(Old code 20714) Stud endcap for 50mm, Antique Bronze, Anodic Grey, Slate Grey, Taupe, Bronze (Available from 1st April 2022)	30.72									A
11652	Design end cap for 50mm, (Hand, Cord, Electric) Antique Bronze, Anodic Grey, Black, Bronze, Ecu, Silver, Slate Grey, Taupe, White and Matt White	30.19	287.47								A
11653	(Old code 20630) Groove cylinder finial only for 50mm - set equivalent 11753 for Cord, 11773 for Hand, or 11763 for Electric	68.85	655.72								A
11654	(Old code 20333) Glass Ball finial only, 50mm, Clear - set equivalent 11754 for Cord, 11774 for Hand or 11764 for Electric	116.29	1007.34								A
11656	(Old code 20717) Ball end finial only for 50mm, Antique Bronze, Anodic Grey, Black, Ecu, Slate Grey, Taupe, White and Matt White - set equivalent 11756 for Cord, 11776 for Hand or 11766 for Electric	90.51	862.14								A
11657	(Old code 20718) Spear finial only for 50mm, Antique Bronze, Anodic Grey, Black, Ecu, Slate Grey, Taupe, White and Matt White - set equivalent 11757 for Cord, 11777 for Hand or 11767 for Electric	134.83	1284.08								A
11658	Ellipse finial only for 50mm, Black, White, Matt White, Ecu, Taupe, Antique Bronze, Anodic Grey and Slate Grey - set equivalent 11758 for Cord, 11778 for Hand or 11768 for Electric	108.25	1030.96								A
11659	Taper finial only for 50mm, Black, White, Matt White, Ecu, Taupe, Antique Bronze, Anodic Grey and Slate Grey - set equivalent 11759 for Cord, 11779 for Hand or 11769 for Electric	71.05	676.70								A
11661	(Old code 20340) Cording Set without endcap for 30mm, Black, Gunmetal, White, Matt White, Charcoal, Ecu, Bronze, Antique Bronze, Anodic Grey, Slate Grey, Ochre, Sand, Taupe and Chrome	56.01	525.01								A
11662	(Old code 20347) Cording Set without endcap for 50mm, Black, White, Matt White, Ecu, Antique Bronze, Anodic Grey, Slate Grey, Taupe, Bronze	66.70	633.74								A
11663	(Old code 6165) Intermediate Pulley for 30mm, Antique Bronze, Anodic Grey, Black, Bronze, Charcoal, Ecu, Gunmetal, Slate Grey, Sand, Ochre, Taupe, White, Matt White, Chrome	76.34	763.37								A
11664	(Old code 20646) Intermediate pulley set for 50mm, White, Black, Ecu, Matt White	78.30									A
11664	(Old code 20646) Intermediate pulley set for 50mm, Taupe, Antique Bronze, Anodic Grey, Slate Grey, Bronze	86.70									A
11665	Finial connector for 23mm	2.53	24.17								A
11666	Finial connector for 30mm Cord	2.86	27.35								A
11667	Finial connector for 50mm Cord	5.34	50.88								A
11668	(Old code 20335) Top Fix Bracket, Silver, Black, Gunmetal, White, Matt White, Charcoal, Ecu, Bronze, Antique Bronze, Anodic Grey, Slate Grey, Ochre, Sand, Taupe	20.78	178.08								A
11668	(Old code 20335) Top Fix Bracket, Chrome	38.65	336.06								A
11669	Fillet Bracket, White, Silver Black, Antique Bronze, Anodic Grey, Bronze, Charcoal, Chrome, Ecu, Gunmetal, Matt White, Ochre, Slate Grey, Sand, Taupe, Chrome	46.20	440.00								A
11700	Finial connector for 30mm Hand	2.86	27.35								A
11701	Finial Connector for 50mm Electric	5.34	50.88								A
11716	Wave single stack return pulley 30mm	22.29	212.30								A
11723	(Old code 20628) Groove cylinder finial set for 23mm, White, Matt White, Ecu, Gunmetal and Charcoal - made up of 11623 + 11665	28.19	268.39								A
11724	(Old code 20329) 23mm Glass Ball finial set clear - made up of 11624 + 11665	60.48	526.14								A
11726	Ball end finial set 23mm, White, Matt White, Ecu, Gunmetal and Charcoal - made up of 11626 and 11665	44.68	425.48								A
11727	Spear finial set 23mm, White, Matt White, Ecu, Gunmetal and Charcoal - made up of 11627 + 11665	29.99	285.56								A
11728	Ellipse finial set 23mm, White, Matt White, Ecu, Gunmetal and Charcoal - made up of 11628 + 11665	20.37	193.98								A
11729	Taper finial set 23mm, White, Matt White, Ecu, Gunmetal and Charcoal - made up of 11629 + 11665	14.16	134.83								A
11733	(Old code 20629) Groove Cylinder finial set for 30mm Cord, made up of 11633 + 11666	34.46	328.18								A
11734	(Old code 20331) Glass Ball finial clear set for 30mm Cord - made up of 11634 + 11666	64.18	558.39								A
11736	(Old code 20556) Ball End finial set, 30mm Cord Black, Gunmetal, White, Matt White, Charcoal, Ecu, Bronze, Antique Bronze, Anodic Grey, Slate Grey, Ochre, Sand and Taupe - made up of 11636 + 11666 (30mm Cord)	48.48	461.79								A
11737	(Old code 20719) Spear finial set, 30mm Cord, Antique Bronze, Anodic Grey, Black, Bronze, Charcoal, Ecu, Gunmetal, Slate Grey, Sand, Ochre, Taupe, White, Matt White - made up of 11637 + 11666	47.29									A

# Price Index for Rails & Parts

 All prices shown  
exclude V.A.T.

Product	Description	Unit Prices					Per Metre Price				Qty
		Each	Per 10	Per 100	Other Qty	Price	1m	100m	Other Lgth	Price	
11738	Ellipse finial set for 30mm Cord , Black, White, Matt White, Ecu, Ochre, Gunmetal, Bronze, Antique Bronze, Sand, Taupe, Anodic Grey, Charcoal and Slate Grey - made up of 11638 + 11666	28.72	273.48								A
11739	Taper finial set for 30mm Cord, Black, White, Matt White, Ecu, Ochre, Gunmetal, Bronze, Antique Bronze, Sand, Taupe, Anodic Grey, Charcoal and Slate Grey - made up of 11639 + 11666	16.09	153.28								A
11743	(Old code 20629) Groove Cylinder finial set for 30mm Hand, made up of 11633 + 11700	34.46	328.18								A
11744	(Old code 20331) Glass Ball finial clear set for 30mm Hand - made up of 11634 + 11700	64.18	558.39								A
11746	(Old code 20556) Ball End finial set, 30mm Hand, Black, Gunmetal, White, Matt White, Charcoal, Ecu, Bronze, Antique Bronze, Anodic Grey, Slate Grey, Ochre, Sand and Taupe - made up of 11636 + 11700 (30mm Hand)	48.48	461.79								A
11747	(Old code 20719) Spear finial set, 30mm Hand, Antique Bronze, Anodic Grey, Black, Bronze, Charcoal, Ecu, Gunmetal, Slate Grey, Sand, Ochre, Taupe, White and Matt White - made up of 11637 + 11700	47.29									A
11748	Ellipse finial set for 30mm Hand, Black, White, Matt White, Ecu, Ochre, Gunmetal, Bronze, Antique Bronze, Sand, Taupe, Anodic Grey, Charcoal and Slate Grey - made up of 11638 + 11700	28.72	273.48								A
11749	Taper finial set for 30mm Hand, Black, White, Matt White, Ecu, Ochre, Gunmetal, Bronze, Antique Bronze, Sand, Taupe, Anodic Grey, Charcoal and Slate Grey - made up of 11639 + 11700	16.09	153.28								A
11753	(Old code 20630) Groove cylinder finial set for 50mm Cord - made up of 11653 + 11667	74.19	706.60								A
11754	(Old code 20333) Glass Ball finial set Clear for 50mm Cord - made up of 11654 + 11667	121.63	1058.22								A
11756	(Old code 20717) Ball end finial set for 50mm Cord, Antique Bronze, Anodic Grey, Black, Ecu, Slate Grey, Taupe, White, Matt White - made up of 11656 + 11667	95.86	913.03								A
11757	(Old code 20718) Spear finial set for 50mm Cord, Antique Bronze, Anodic Grey, Black, Ecu, Slate Grey, Taupe, White and Matt White - made up of 11657 + 11667	140.17	1334.96								A
11758	Ellipse finial set for 50mm Cord, Black, White, Matt White, Ecu, Taupe, Antique Bronze, Anodic Grey and Slate Grey - made up of 11658 + 11667	113.59	1081.84								A
11759	Taper finial set for 50mm Cord, Black, White, Matt White, Ecu, Taupe, Antique Bronze, Anodic Grey and Slate Grey - made up of 11659 + 11667	76.39	727.58								A
11763	Groove cylinder finial set for 50mm Electric - made up of 11653 + 11701	74.19	706.69								A
11764	(Old code 20333) Glass Ball finial set, 50mm (Electric), clear - made up of 11654 + 11701	121.63	1058.22								A
11766	Ball End finial set, 50mm (Electric) Antique Bronze, Bronze, Anodic Grey, Black, Ecu, Slate Grey, Taupe, White and Matt White - made up of 11656 + 11701	95.86	913.03								A
11767	Spear finial set, 50mm (Electric) Antique Bronze, Bronze, Anodic Grey, Black, Ecu, Slate Grey, Taupe, White and Matt White - made up of 11657 + 11701	140.17	1334.96								A
11768	Ellipse finial set, 50mm (Electric) Ecu, White, Black, Matt White, Anodic Grey, Slate Grey, Antique Bronze, Bronze and Taupe - made up of 11658 + 11701	113.59	1081.84								A
11769	Taper finial set, 50mm (Electric) Ecu, White, Black, Matt White, Anodic Grey, Slate Grey, Antique Bronze, Bronze and Taupe - made up of 11659 + 11701	76.39	727.58								A
11773	(Old code 20630) Groove cylinder finial set for 50mm Hand - made up of 11653 + 11782	74.19	706.60								A
11774	(Old code 20333) Glass Ball Finial Clear set for 50mm Hand - made up of 11654 + 11782	121.63	1058.22								A
11776	(Old code 20717) Ball end finial set for 50mm Hand, Antique Bronze, Anodic Grey, Black, Ecu, Slate Grey, Taupe, White and Matt White - made up of 11656 + 11782	95.86	913.03								A
11777	(Old code 20718) Spear finial set for 50mm Hand, Antique Bronze, Anodic Grey, Black, Ecu, Slate Grey, Taupe, White, Matt White - made up of 11657 + 11782	140.17	1334.96								A
11778	Ellipse finial set for 50mm Hand, Black, White, Matt White, Ecu, Taupe, Antique Bronze, Anodic Grey and Slate Grey - made up of 11658 + 11782	113.59	1081.84								A
11779	Taper finial set for 50mm Hand, Black, White, Matt White, Ecu, Taupe, Antique Bronze, Anodic Grey and Slate Grey - made up of 11659 + 11782	76.39	727.58								A
11782	Finial connector for 50mm Hand	5.34	50.88								A
11783	Connecting Bridge for 50mm Hand, Antique Bronze, Anodic Grey, Black, Ecu, Silver, Slate Grey, Taupe, White, Matt White	32.63									A
20329	(New code 11724) 23mm Glass Ball finial clear (all pole colours)	60.48	526.14								A
20331	(New code 30mm Cord 11734, 30mm Hand 11744) 30mm Glass Ball finial clear	64.18	558.39								A
20333	(New code 50mm Hand or Cord 11754) 50mm Glass Ball finial clear (50mm Electric use 11764)	121.63	1058.22								A
20334	Maxi Adjustable Bracket, Silver, Black, Gunmetal, White, Matt White, Charcoal, Ecu, Bronze, Antique Bronze, Anodic Grey, Slate Grey, Ochre, Sand, Taupe	36.96	351.99								A
20335	(New code 11668) Top Fix Bracket, Silver, Black, Gunmetal, White, Matt White, Charcoal, Ecu, Bronze, Antique Bronze, Anodic Grey, Slate Grey, Ochre, Sand, Taupe	20.78	178.08								A
20335	(New code 11668) Top Fix Bracket, chrome	38.65	336.06								A
20336	Eight channel hand held remote	215.49									C
20339	(New code 11602) 23mm Flush Endcap, Silver, Charcoal, Ecu, White, Matt White Gunmetal, Chrome	11.29	110.26								A
20340	(New code 11661) 30mm Cording Set without endcap, Black, Gunmetal, White, Matt White, Charcoal, Ecu, Bronze, Antique Bronze, Anodic Grey, Slate Grey, Ochre, Sand, Taupe and Chrome	56.01	525.01								A
20346	(New code 11603) 30mm Flush Endcap, Silver, Black, Gunmetal, White, Matt White, Charcoal, Ecu, Bronze, Antique Bronze, Anodic Grey, Slate Grey, Ochre, Sand, Taupe, Chrome	9.63	91.33								A
20347	(New code 11662) 50mm Cording Set without endcap, Black, White, Matt White, Ecu, Antique Bronze, Anodic Grey, Slate Grey, Taupe	66.70	633.74								A
20350	(New code 11605) 50mm Flush Endcap, Silver, White, Matt White, Ecu, Black	29.99	293.90								A

# Price Index for Rails & Parts

All prices shown  
exclude V.A.T.

Product	Description	Unit Prices					Per Metre Price				Qty
		Each	Per 10	Per 100	Other Qty	Price	1m	100m	Other Lgth	Price	
20350	(New code 11605) 50mm Flush Endcap, Antique Bronze, Anodic Grey, Slate Grey, Taupe	30.73	301.09								A
20351	(New code 11601) 36mm Flush Endcap, Silver, Black, White, Matt White, Gunmetal, Chrome, Antique Bronze, Bronze, Slate Grey, Charcoal, Anodic Grey	9.77	95.79								A
20556	(New code 30mm Cord 11736 or 30mm Hand 11746) Ball end, Black, Gunmetal, White, Matt White, Charcoal, Ecu, Bronze, Antique Bronze, Anodic Grey, Slate Grey, Ochre, Sand and Taupe 30mm poles	48.48	461.79								A
20628	(New code 11723) Groove cylinder finial for 1003	28.19	268.39								A
20629	(New code 30mm Cord 11733, 30mm Hand 11743 Groove cylinder finial for 30mm	34.46									A
20630	(New code - 11753 50mm Cord, 11773 Hand) Groove cylinder finial (50mm Electric use 11763)	74.19	706.60								A
20646	(New code 11664) 50mm intermediate pulley set (for 6160), White, Black, Ecu, Matt White	78.30									A
20646	(New code 11664) 50mm intermediate pulley set (for 6160), Taupe, Antique Bronze, Anodic Grey, Slate Grey	86.70									A
20700	(New code 11609) Profile for 6140 Black, Ecu, Silver, White, Matt White						53.68				A
20700	(New code 11609) Profile for 6140 Antique Bronze, Anodic Grey, Slate Grey, Taupe,						72.75				A
20701	(New code 11607) 50mm corded profile, Black, Ecu, Silver, White, Matt White						84.85				A
20701	(New code 11607) 50mm corded profile, Antique Bronze, Anodic Grey, Slate Grey, Taupe,						98.35				A
20706	(New code as of 1st April 2022 - 11621) Stud endcap for 23mm, Ecu, Gunmetal, Charcoal, Silver, White, Matt White, Chrome	11.28	110.27	1025.70							A
20707	(New code as of 1st April 2022 - 11631) Stud endcap for 30mm, Antique Bronze, Anodic Grey, Black, Bronze, Charcoal, Ecu, Gunmetal, Slate Grey, Silver, Sand, Ochre, Taupe, White, Matt White, Chrome	9.63	91.33	867.66							A
20710	(New code as of 1st April 2022 - 11611) Stud endcap for 6101, Antique Bronze, Anodic Grey, Black, Gunmetal, Charcoal, Silver, Slate Grey, White, Matt White, Chrome, (includes grub screw)	9.76	92.84	879.45							A
20714	(New code as of 1st April 2022 - 11651) Stud endcap for 50mm, Black, Ecu, Silver, White, Matt White	29.99									A
20714	(New code as of 1st April 2022 - 11651) Stud endcap for 50mm, Antique Bronze, Anodic Grey, Slate Grey, Taupe	30.72									A
20717	(New code - 11756 50mm Cord, 11776 Hand) Ball end finial 50mm (For Electric use code 11766) Antique Bronze, Anodic Grey, Black, Ecu, Slate Grey, Taupe, White, Matt White	95.86									A
20718	(New code - 11757 50mm Cord, 11777 Hand) Spear finial 50mm (for Electric use 11767) Antique Bronze, Anodic Grey, Black, Ecu, Slate Grey, Taupe, White and Matt White	140.17	1334.96								A
20719	(New code as of 1st April 2022 -30mm cord 11737, 30mm Hand 11747) Spear finial 30mm Antique Bronze, Anodic Grey, Black, Bronze, Charcoal, Ecu, Gunmetal, Slate Grey, Sand, Ochre, Taupe, White, Matt White	47.29									A
20798	(Old code 11127) M4 x 10 CSK. Head Screw for 6138P/6141	24.32									A
20873	(New code as of 1st April 2022 - 11632) Design end cap for 30mm, Antique Bronze, Anodic Grey, Black, Bronze, Charcoal, Ecu, Gunmetal, Slate Grey, Sand, Ochre, Taupe, White and Matt White	21.28									A
20907	Control module (low voltage motor Type A)	380.58									C
20913	Single-channel wall switch, antique brass, black nickle, chocolate bronze, matt black, matt white, polished brass, brushed silver, mirror finish	291.90									C
20914	Eight-channel wall switch, antique brass, black nickle, chocolate bronze, matt black, matt white, polished brass, brushed silver, mirror finish	291.90									C
20917	White pattress box	24.65									C
20918	Control Module (Motor Type A)	352.53									C
20919	Control Module (Motor Type B)	352.53									C

## Tools &amp; Packaging

All prices shown  
exclude V.A.T.

Product	Description	Unit Prices					Per Metre Price				Ctgy
		Each	Per 10	Per 100	Other Qty	Price	1m	100m	Other Lgth	Price	
0388	Action Motor Setting Tool	34.21									E
538	Bending Kit for 7103/7109 incl fillers, blocks, arms and rings for system 3840	193.22									E
539	Crimping tool	367.70									E
545	Bending Kit for 7103/7109 incl. fillers, blocks, arms and rings for system 3900	390.29									
547	Bending block set (6103)	417.41									E
0587	2.5mm Allen Key for Metropole	0.11									E
0600	Connector tongs for metal chain	71.83									E
679	Joining pliers for bead chain 4845	147.34									E
0722	2mm Allen Key	0.61									E
6827	Funnel Fixing Tool	5.92									E
7004	Cording needle	2.17									E
7037	Bending fillers 6100	44.10									E
7103	Portable hand operated bending tool for 1080, 1280, 3000, 3840/6840 and 3900 complete with sets of fillers	1698.18									E
7109	Portable electrically operated bending tool for 1080, 3000, 3840/6840 1280 and 3900 complete with sets of fillers	1815.12									E
7223	Tongs for connector 2865	463.29									E
7230	Slotting tool for wide channel profiles	231.61									E
7244	Notching tool for 6465 recess profile	69.74									E
7245	Notching tool for 3870/6870 recess profile	69.74									E
7246	Notching tool for 3970/6970/5600 recess profile	69.74									E
7404	Former for 7103/7109 radius 15cm	111.35									E
7432	Bending ring 15cm 1003 for 7103/9	75.02									E
7439	Blocks for 7103/7109 for 6010 profile, 2 required	9.72									E
7550	Centre tool	97.29									E
7802	Filler set 3840 for 7103/9, 200 cm	177.68									E
7803	Filler set 3900 for 7103/9, 200 cm	104.36									E
7803A	Filler set 3900 for 7103/9, 70 cm	315.98									E
7805	Filler set 3000 for 7103/9, 200 cm	164.02									E
7805A	Filler set 3000 for 7103/9, 70 cm	90.84									E
7806	Filler set 1080 for 7103/9, 200 cm	44.23									E
7806A	Filler set 1080 for 7103/9, 70 cm	259.09									E
7844	Filler set 1280 for 7103/9, 70cm	139.68									E
7844A	Filler set 1280 for 7103/9, 200cm	257.20									E
7848	Filler set 1003 for 7103/9, 70cm	51.00									E
7885	Filler set 6010 for 7103/7109, 200cm	201.51									E
10480	Child Safety Device (4.5mm metal to metal bead chain)	11.43									E
10481	Child Safety Device (4.5mm plastic to plastic bead chain)	11.43									E
10482	Child Safety Device (4mm metal to metal bead chain)	11.43									E
10537	Joining pliers for 10530 chain (4910)	79.27									E
11269	Hand held setting tool for Series 40 and SMART motors (TTPRO)	119.72									E
11422	230V Setting Lead	35.91									E
80018	Slotting tool	536.91									E
B5	Bending block for 6100	501.75									E
SF	Silicone fluid, litre	64.08									E
Labour	To fully assemble cabinet with SMART Gateway, expansion unit (if required) and power supplies:										
	Up to 8 systems (Labour cost only)	98.21									E
	Up to 24 systems (Labour cost only)	264.42									E
	Up to 56 systems (Labour cost only)	679.94									E

## Application Chart for Silent Gliss®Switches, Remote Control and Multiple Operation of Motorised Systems

	Fixed Switch (Hard Wired)	Radio Control Systems 0450			Radio Control Systems 9940		*SMART	System
		Hand Held Remotes/Receiver	Wall Switched	Move Server Set	Hand Held Remote/Receiver	Wall Switches & Light Sensors	Via Gateway	
	0615/6/7/8/9 Latching	Remote 20336 Receiver 20919	Wall Switch 20913/ 20914 Receiver 20919	9960. 9961	Remote 10300/10302/ 10303/10804 Receiver 9068/9945	Wall Switch 11480 Receiver 9068/9944/9945	n/a	2195
	Motor 10522/10322 0615/6/7/8/9 Latching	Motor 10322/10522 Remote 20336 Receiver 20919	Motor 10322/10522 Wall Switch 20913/ 20914 Receiver 20919	9960. 9961	Motor 11241/11244 Remote 10300/10302/ 10303/10804 Receiver Integrated	Motor 11241/11244 Wall Switch 11480/11490 Receiver Integrated	11251	2350
	Motor 9090 0613 5 Position	Motor 9091 Remote 20336 Receiver Intergrated	Motor 9091 Wall Switch 20913/ 20914 Receiver Intergrated	9960. 9961	Motor 9091EL Remote 10300/10302/ 10303/10804 Receiver Integrated	Motor 9091EL Wall Switch 11480/11490 Receiver Integrated	n/a	2950
	Motor 10522 0615/6/7/8/9 Latching	Motor 10522 Remote 20336 Receiver 20919	Motor 10522 Wall Switch 20913/ 20914 Receiver 20919	9960. 9961	Motor 11241/11244 Remote 10300/10302/ 10303/10804 Receiver Integrated	Motor 11241/11244 Wall Switch 11480/11490 Receiver Integrated	11251	4760
	Motor 10522 0615/6/7/8/9 Latching	Motor 10522 Remote 20336 Receiver 20919	Motor 10522 Wall Switch 20913/ 20914 Receiver 20919	9960. 9961	Motor 11241/11244 Remote 10300/10302/ 10303/10804 Receiver Integrated	Motor 11241/11244 Wall Switch 11480/11490 Receiver Integrated	11251	4770
	Motor 10522 0615/6/7/8/9 Latching	Motor 10522 Remote 20336 Receiver 20919	Motor 10522 Wall Switch 20913/ 20914 Receiver 20919	9960. 9961	Motor 11241/11244 Remote 10300/10302/ 10303/10804 Receiver Integrated	Motor 11241/11244 Wall Switch 11480/11490 Receiver Integrated	11251	4780
	10692 (0631)	n/a	n/a	n/a	n/a	n/a	n/a	4960
	Motor 10320 0615/6/7/8/9 Latching	Motor 10320 Remote 20336 Receiver 20919	Motor 10320 Wall Switch 20913/ 20914 Receiver 20919	9960. 9961	Motor 11248/11249 Remote 10300/10302/ 10303/10804 Receiver Integrated	Motor 11240/11243 Wall Switch 11480/11490 Receiver Integrated	11250	4960
	Motor 10522 0615/6/7/8/9 Latching	Motor 10522 Remote 20336 Receiver 20919	Motor 10522 Wall Switch 20913/ 20914 Receiver 20919	9960. 9961	Motor 11248/11249 Remote 10300/10302/ 10303/10804 Receiver Integrated	Motor 11241/11244 Wall Switch 11480/11490 Receiver Integrated	11251	4970
	Motor 10326 0615/6/7/8/9 Latching	Motor 10522 Remote 20336 Receiver 20919	Motor 10326 Wall Switch 20913/ 20914 Receiver 20919	9960. 9961	Motor 11248/11249 Remote 10300/10302/ 10303/10804 Receiver Integrated	Motor 11248/11249 Wall Switch 11480/11490 Receiver Integrated	11255	4880
9060	Motor 9060 0615/6/7/8/9	Motor 9060 Remote 20336 Receiver Module 11411	Motor 9060 Remote 20336 Receiver Module 11411	9960. 9961	Motor 9060 Remote 10300/10302/ 10303/10804 Receiver Module 9063	Motor 9060 Wall Switch 11480/11490 Receiver Module 9063	11270	5600
5805	0615/6/7/8/9 Latching	n/a	n/a	9960. 9961	Remote 10300/10302/ 10303/10804 Receiver Module 9060	Wall Switch 11480 Receiver 9068	n/a	5800
8060	0928 5 Position	Motor 8060 Remote 20336 Receiver 20907 (Pulse Enabled)	Wall Switch 20913/20914 Receiver 20907 (Pulse Enabled)	9960. 9961	Remote 10300/10302/ 10303/10804 Receiver Module 9068/9947	Wall Switch 11480 Receiver 9068/9947	n/a	8250

\*Refer to page 28 for SMART components

## Application Chart for Silent Gliss® Switches, Remote Control and Multiple Operation of Motorised Systems

Motor Number	Fixed Switch (Hard Wired)	Radio Control Systems 0450		Radio Control Systems 9940			*SMART	System
		Hand Held Remotes	Wall Switched	Move Server Set	Hand Held Remote	Wall Switches & Light Sensors	Via Gateway	
		Wall Switch 20913/20914 Receiver 20907	Wall Switch 20913/20914 Receiver 20907	9960/ 9961	Remote 10300/10302/ 10303/10804 Receiver 9068/9947	Wall Switch 11480/11490 Receiver 9068/9947	n/a	8500
8605	0615/6/7/8/9 Latching	Wall Switch 20913/20914 Receiver 20919	Wall Switch 20913/20914 Receiver 20919	9960/ 9961	Remote 10300/10302/ 10303/10804 Receiver 9068/9945	Wall Switch 11480/11490 Receiver 9068/9945	n/a	8600
	0615/6/7/8/9 Latching	n/a	n/a	9960/ 9961	Remote 10300/10302/ 10303/10804 Receiver 9068/9945	Wall Switch 11480/11490 Receiver 9068	n/a	8640
11096	0613 5 Position	Wall Switch 20913/20914 Receiver Integrated	Wall Switch 20913/20914 Receiver Integrated	9960/ 9961	Remote 10300/10302/ 10303/10804 Receiver Integrated	Wall Switch 11480/11490 Receiver Integrated	n/a	8960

## Battery Operated Blinds Application Chart for Remote Control Switches and Wall Plates

Motor	Hand Wired Switch	Wall Plates	Hand Held Remote	Move Server Set	9940	0450	SMART	Timer and Control	System
11076	n/a	10949, 10950, 10951	10946, 10947, 10948	n/a	n/a	n/a	n/a	11429	4955
11076	n/a	10949, 10950, 10951	10946, 10947, 10948	n/a	n/a	n/a	n/a	11429	2345
5190	n/a	10949	10946, 10947, 10948	n/a	n/a	n/a	n/a		5100B
5190	n/a	10949, 10950	10946, 10947, 10948	n/a	n/a	n/a	n/a		5100R
5190	n/a	10949, 10950	10946, 10947, 10948	n/a	n/a	n/a	n/a	11429	5100T
5190	n/a	10949, 10950, 10951	10946, 10947, 10948	n/a	n/a	n/a	n/a	11429	5100TC



For motor types and connections see wiring diagrams.

# Terms & Conditions of Trading with Silent Gliss Ltd

The buyer's attention is in particular drawn to the provisions of condition 12.4.

## 1. INTERPRETATION

1.1 The definitions and rules of interpretation in this condition apply in these conditions.

**Buyer:** the person, firm or company who purchases the Goods and/or Services from the Company.

**Company:** Silent Gliss Ltd.

**Contract:** any contract between the Company and the Buyer for the sale and purchase of the Goods and/or provision of Services, incorporating these conditions.

**Delivery Point:** the place where delivery of the Goods is to take place under condition 4.

**Goods:** any goods agreed in the Contract to be supplied to the Buyer by the Company (including any part or parts of them).

**Services:** any installation services agreed in the Contract to be supplied to the Buyer by the Company.

- 1.2 A reference to a particular law is a reference to it as it is in force for the time being taking account of any amendment, extension, application or re-enactment and includes any subordinate legislation for the time being in force made under it.
- 1.3 Words in the singular include the plural and in the plural include the singular.
- 1.4 A reference to one gender includes a reference to the other gender.
- 1.5 Condition headings do not affect the interpretation of these conditions.

## 2. APPLICATION OF TERMS

- 2.1 Subject to any variation under condition 2.3 the Contract shall be on these conditions to the exclusion of all other terms and conditions (including any terms or conditions which the Buyer purports to apply under any purchase order, confirmation of order, specification or other document).
- 2.2 No terms or conditions endorsed on, delivered with or contained in the Buyer's purchase order, confirmation of order, specification or other document shall form part of the Contract simply as a result of such document being referred to in the Contract.
- 2.3 These conditions apply to all the Company's sales and any variation to these conditions and any representations about the Goods and/or Services shall have no effect unless expressly agreed in writing and signed by the Sales Director of the Company. The Buyer acknowledges that it has not relied on any statement, promise or representation made or given by or on behalf of the Company which is not set out in the Contract. Nothing in this condition shall exclude or limit the Company's liability for fraudulent misrepresentation.
- 2.4 Each order or acceptance of a quotation for Goods and/or Services from the Company shall be deemed to be an offer by the Buyer to buy Goods and/or Services subject to these conditions.
- 2.5 No order placed by the Buyer shall be deemed to be accepted by the Company until a written acknowledgement of order is issued by the Company or (if earlier) the Company delivers the Goods to and/or carries out the Services for the Buyer.
- 2.6 The Buyer shall ensure that the terms of its order and any applicable specification are complete and accurate.
- 2.7 Any quotation is given on the basis that no Contract shall come into existence until the Company despatches an acknowledgement of order to the Buyer. Any quotation is valid for a period of 60 days only from its date, provided that the Company has not previously withdrawn it.

## 3. DESCRIPTION

- 3.1 The quantity and description of the Goods and/or Services shall be as set out in the Company's quotation or acknowledgement of order.
- 3.2 All samples, drawings, descriptive matter, specifications and advertising issued by the Company and any descriptions or illustrations contained in the Company's catalogues or brochures are issued or published for the sole purpose of giving an approximate idea of the Goods described in them. They shall not form part of the Contract and this is not a sale by sample.

## 4. DELIVERY

- 4.1 Unless otherwise agreed in writing by the Company, delivery of the Goods shall take place at the time the Goods have been unloaded at the delivery address nominated by the Buyer.

4.2 The Buyer shall take delivery of the Goods within 30 days of the Company giving it notice that the Goods are ready for delivery.

4.3 Any dates specified by the Company for delivery of the Goods or commencement or duration for performance of the Services are intended to be an estimate and time for delivery and/or performance shall not be made of the essence by notice. If no dates are so specified, delivery and/or performance shall be within a reasonable time.

4.4 Subject to the other provisions of these conditions the Company shall not be liable for any direct, indirect or consequential loss (all three of which terms include, without limitation, pure economic loss, loss of profits, loss of business, depletion of goodwill and similar loss), costs, damages, charges or expenses caused directly or indirectly by any delay in the delivery of the Goods or performance of the Services (even if caused by the Company's negligence), nor shall any delay entitle the Buyer to terminate or rescind the Contract unless such delay exceeds 60 days.

4.5 If for any reason the Buyer fails to accept delivery of any of the Goods when they are ready for delivery, or the Company is unable to deliver the Goods on time because the Buyer has not provided appropriate instructions, documents, licences or authorisations:

- (a) risk in the Goods shall pass to the Buyer (including for loss or damage caused by the Company's negligence);
- (b) the Goods shall be deemed to have been delivered; and
- (c) the Company may store the Goods until delivery, whereupon the Buyer shall be liable for all related costs and expenses (including, without limitation, storage and insurance).

4.6 If the Company delivers to the Buyer a quantity of Goods of up to 5% more or less than the quantity accepted by the Company, the Buyer shall not be entitled to object to or reject the Goods or any of them by reason of the surplus or shortfall and shall pay for such goods at the pro rata Contract rate.

4.7 The Company may deliver the Goods by separate instalments. Each separate instalment shall be invoiced and paid for in accordance with the provisions of the Contract.

4.8 Each instalment shall be a separate Contract and no cancellation or termination of any one Contract relating to an instalment shall entitle the Buyer to repudiate or cancel any other Contract or instalment.

## 5. CANCELLATIONS AND RETURNS

The Buyer shall not be entitled to cancel any Contract or return Goods for refund without the prior written consent of the Company (which will be the absolute discretion of the Company) and payment of a handling charge of 20% of the Price in respect of ex stock items and in the case of made-to-measure items a percentage of the Price dependent upon the stage of manufacture reached at the point of cancellation.

## 6. NON-DELIVERY

- 6.1 The quantity of any consignment of Goods as recorded by the Company upon despatch from the Company's place of business shall be conclusive evidence of the quantity received by the Buyer on delivery unless the Buyer can provide conclusive evidence proving the contrary.
- 6.2 The Company shall not be liable for any non-delivery of Goods (even if caused by the Company's negligence) unless the Buyer gives written notice to the Company of the non-delivery within 7 days of the date when the Goods would in the ordinary course of events have been received.
- 6.3 Any liability of the Company for non-delivery of the Goods shall be limited to replacing the Goods within a reasonable time or issuing a credit note at the pro rata Contract rate against any invoice raised for such Goods.

## 7. INSTALLATION

7.1 All costs in relation to installation by the Company shall be payable by the Buyer in addition to the price of the Goods. The following standard charges apply (duration of each installation is dependent on the type of work being carried out):

- £400 + VAT per day (per engineer)
- £285 + VAT per ½ day (per engineer)
- £285 + VAT Service Callout (parts not included)

7.2 The Buyer shall be solely responsible for ensuring that its site and adequate and safe access thereto is ready for installation of the Goods. Fixing points must be adequate for the proper and secure installation of the Goods. The Buyer must pay for the cost of any modification to its site or the Goods that is required to enable the Goods to be properly installed.

- 7.3 The Buyer shall be solely responsible for all ancillary work required and costs incurred in connection with installation of Goods, including (without limitation) access, scaffolding hire, electrical work, decorating, or making good.
- 7.4 The Buyer shall advise the Company of any hidden obstruction (including without limitation, electricity, telephone and other communications cables and water, gas and drainage pipes) that may be encountered during installation of the Goods. The Company will not be liable for any damage to any structure, surface or service. The Buyer will pay all costs incurred by the Company in consequence of any damage to any hidden obstruction and will indemnify the Company against all liability, loss, cost and expense that it incurs arising out of or in consequence of installation of the Goods or damage to any structure, surface or service.
- 7.5 At all times, suppliers must comply with the Regulations. The Regulations provide that the Suppliers performing the installation services must fit any safety device supplied with the Goods.
- (a) In the event that the Customer should refuse to allow the Supplier to fit any such safety device accompanying the Goods, then the Supplier will be at liberty to refuse to carry out the Services. In such instance, the Customer will still be liable to pay the Supplier the Price in full under the Contract.
- (b) The Customer shall not be entitled to treat the Suppliers refusal to carry out any Services in relation to the Goods for the reasons set out in this clause 7.4 as a fundamental or any breach of contract. The Customer will still be bound under the Contract to take delivery of the Goods.
- 7.6 The parties to the contract consider the provisions of this clause 7.4 to be reasonable under all the circumstances given the Supplier's obligations under the Regulations.
- 8. RISK/TITLE**
- 8.1 The Goods are at the risk of the Buyer from the time of delivery.
- 8.2 Ownership of the Goods shall not pass to the Buyer until the Company has received in full (in cash or cleared funds) all sums due to it in respect of:
- (a) the Goods; and
- (b) all other sums which are or which become due to the Company from the Buyer on any account.
- 8.3 Until ownership of the Goods has passed to the Buyer, the Buyer shall:
- (a) hold the Goods on a fiduciary basis as the Company's bailee;
- (b) store the Goods (at no cost to the Company) separately from all other goods of the Buyer or any third party in such a way that they remain readily identifiable as the Company's property;
- (c) not destroy, deface or obscure any identifying mark or packaging on or relating to the Goods; and
- (d) maintain the Goods in satisfactory condition and keep them insured on the Company's behalf for their full price against all risks to the reasonable satisfaction of the Company. On request the Buyer shall produce the policy of insurance to the Company.
- 8.4 The Buyer may resell the Goods before ownership has passed to it solely on the following conditions:
- (a) any sale shall be effected in the ordinary course of the Buyer's business at full market value; and
- (b) any such sale shall be a sale of the Company's property on the Buyer's own behalf and the Buyer shall deal as principal when making such a sale.
- 8.5 The Buyer's right to possession of the Goods shall terminate immediately if:
- (a) the Buyer has a bankruptcy order made against him or makes an arrangement or composition with his creditors, or otherwise takes the benefit of any statutory provision for the time being in force for the relief of insolvent debtors, or (being a body corporate) convenes a meeting of creditors (whether formal or informal), or enters into liquidation (whether voluntary or compulsory) except a solvent voluntary liquidation for the purpose only of reconstruction or amalgamation, or has a receiver and/or manager, administrator or administrative receiver appointed of its undertaking or any part thereof, or documents are filed with the court for the appointment of an administrator of the Buyer or notice of intention to appoint an administrator is given by the Buyer or its directors or by a qualifying floating charge holder (as defined in paragraph 14 of Schedule B1 to the Insolvency Act 1986), or a resolution is passed or a petition presented to any court for the winding-up of the Buyer or for the granting of an administration order in respect of the Buyer, or any proceedings are commenced relating to the insolvency or possible insolvency of the Buyer; or
- (b) the Buyer suffers or allows any execution, whether legal or equitable, to be levied on his/its property or obtained against him/it, or fails to observe or perform any of his/its obligations under the Contract or any other contract between the Company and the Buyer, or is unable to pay its debts within the meaning of section 123 of the Insolvency Act 1986 or the Buyer ceases to trade; or
- (c) the Buyer encumbers or in any way charges any of the Goods.
- 8.6 The Company shall be entitled to recover payment for the Goods notwithstanding that ownership of any of the Goods has not passed from the Company.
- 8.7 The Buyer grants the Company, its agents and employees an irrevocable licence at any time to enter any premises where the Goods are or may be stored in order to inspect them, or, where the Buyer's right to possession has terminated, to recover them.
- 8.8 Where the Company is unable to determine whether any Goods are the goods in respect of which the Buyer's right to possession has terminated, the Buyer shall be deemed to have sold all goods of the kind sold by the Company to the Buyer in the order in which they were invoiced to the Buyer.
- 8.9 On termination of the Contract, howsoever caused, the Company's (but not the Buyer's) rights contained in this condition 8 shall remain in effect.
- 9. PRICE**
- 9.1 Unless otherwise agreed by the Company in writing, the price for the Goods and/or Services shall be the price set out in the Company's price list published on the date of delivery or deemed delivery.
- 9.2 The price for the Goods and/or Services shall be exclusive of any value added tax.
- 9.3 All costs or charges in relation to carriage and insurance during transit shall be payable by the Buyer in addition to the price of the Goods when it is due to pay for the Goods where the price of the Goods in any Contract is less than £250 before value-added tax, and in all other cases such costs or charges shall be borne by the Company.
- 9.4 For shipments outside UK mainland, i.e. Highlands, Channel Islands, the Company reserves the right to charge a delivery supplement.
- 10. PAYMENT**
- 10.1 Subject to condition 10.4, payment of the price for the Goods is due in pounds sterling on the last working day of the month following the month in which the Goods are delivered or deemed to be delivered and/or the services are performed.
- 10.2 Time for payment shall be of the essence.
- 10.3 No payment shall be deemed to have been received until the Company has received cleared funds.
- 10.4 All payments payable to the Company under the Contract shall become due immediately on its termination despite any other provision.
- 10.5 The Buyer shall make all payments due under the Contract in full without any deduction whether by way of set-off, counterclaim, discount, abatement or otherwise unless the Buyer has a valid court order requiring an amount equal to such deduction to be paid by the Company to the Buyer.
- 10.6 If the Buyer fails to pay the Company any sum due pursuant to the Contract, the Buyer shall be liable to pay interest to the Company on such sum from the due date for payment at the annual rate of 1.5% per month, accruing on a daily basis until payment is made, whether before or after any judgment.
- 11. QUALITY**
- 11.1 The Company warrants that (subject to the other provisions of these conditions):
- (a) upon delivery, and for a period of five years from the date of delivery the Goods shall
- (i) be of satisfactory quality within the meaning of the Sale of Goods Act 1979;
- (ii) be reasonably fit for purpose; and
- (b) the Services shall be performed with reasonable skill and care.
- (c) This warranty applies to hardware only. Fabric is subject to suppliers' guarantees.
- 11.2 The Company shall not be liable for a breach of any of the warranties in condition 11.1 unless:
- (a) the Buyer gives written notice of the defect to the Company, and, if the defect is as a result of damage in transit to the carrier, within 7 days of the time when the Buyer discovers or ought to have discovered the defect;

- (b) where the contract is for supply only of Goods the Company is given a reasonable opportunity after receiving the notice of examining the Goods and the Buyer (if asked to do so by the Company) returns such Goods to the Company's place of business at the Company's cost for the examination to take place there; and
  - (c) where the Contract is for supply and installation of Goods the Company is given a reasonable opportunity after receiving notice of examining the Goods and their installation on site.
- 11.3 The Company shall not be liable for a breach of any of the warranties in condition 11.1 if:
- (a) the Buyer makes any further use of such Goods after giving such notice; or
  - (b) the defect arises because the Buyer failed to follow the Company's oral or written instructions as to the storage, installation, commissioning, use or maintenance of the Goods or (if there are none) good trade practice; or
  - (c) the Buyer alters or repairs such Goods without the written consent of the Company.

11.4 Subject to condition 11.2 and condition 11.3, if any of the Goods and/or Services do not conform with any of the warranties in condition 11.1 the Company shall

- (a) if the Contract is for supply only of Goods, at its option repair or replace such Goods (or the defective part) or refund the price of such Goods at the pro rata Contract rate provided that, if the Company so requests, the Buyer shall, at the Company's expense, return the Goods or the part of such Goods which is defective to the Company;
  - (b) if the Contract includes installation of Goods by the Company, the Services shall be reperformed by the Company on site until such Services are in conformity or at the Company's option it may pay for the Services to be performed again.
- 11.5 If the Company complies with condition 11.4 it shall have no further liability for a breach of any of the warranties in condition 11.1 in respect of such Goods and/or Services.
- 11.6 Any Goods replaced shall belong to the Company and any repaired or replacement Goods shall be guaranteed on these terms for the unexpired portion of the five year period.
- 11.7 The Buyer is responsible for ensuring the suitability of and absence from manufacturing flaws in any fabric supplied by the Buyer and for marking any such flaws. The Company is not responsible for the performance of any fabric supplied by the Buyer, including (without limitation) its adhesive capabilities when attaching bond cloth, shrinkage, matching of patterns and manufacture into roller blinds. The Buyer is responsible for all fabric and labour costs of remedying fabric flaws discovered by the Company in the course of manufacturing the Goods.

## 12. LIMITATION OF LIABILITY

- 12.1 Subject to condition 4, condition 6 and condition 11, the following provisions set out the entire financial liability of the Company (including any liability for the acts or omissions of its employees, agents and sub-contractors) to the Buyer in respect of:
- (a) any breach of these conditions;
  - (b) any use made or resale by the Buyer of any of the Goods, or of any product incorporating any of the Goods; and
  - (c) any representation, statement or tortious act or omission including negligence arising under or in connection with the Contract.
- 12.2 All warranties, conditions and other terms implied by statute or common law (save for the conditions implied by section 12 of the Sale of Goods Act 1979) are, to the fullest extent permitted by law, excluded from the Contract.
- 12.3 Nothing in these conditions excludes or limits the liability of the Company:
- (a) for death or personal injury caused by the Company's negligence; or
  - (b) under section 2(3), Consumer Protection Act 1987; or
  - (c) for any matter which it would be illegal for the Company to exclude or attempt to exclude its liability; or
  - (d) for fraud or fraudulent misrepresentation.
- 12.4 Subject to condition 12.2 and condition 12.3:
- (a) the Company's total liability in contract, tort (including negligence or breach of statutory duty), misrepresentation, restitution or otherwise, arising in connection with the performance or contemplated performance of the Contract shall be limited to the Contract price; and

- (b) the Company shall not be liable to the Buyer for any pure economic loss, loss of profit, loss of business, depletion of goodwill or otherwise, in each case whether direct, indirect or consequential, or any claims for consequential compensation whatsoever (howsoever caused) which arise out of or in connection with the Contract.

## 13. ASSIGNMENT

- 13.1 The Company may assign the Contract or any part of it to any person, firm or company.
- 13.2 The Buyer shall not be entitled to assign the Contract or any part of it without the prior written consent of the Company.

## 14. FORCE MAJEURE

The Company reserves the right to defer the date of delivery or to cancel the Contract or reduce the volume of the Goods ordered by the Buyer (without liability to the Buyer) if it is prevented from or delayed in the carrying on of its business due to circumstances beyond the reasonable control of the Company including, without limitation, acts of God, governmental actions, war or national emergency, acts of terrorism, protests, riot, civil commotion, fire, explosion, flood, epidemic, lock-outs, strikes or other labour disputes (whether or not relating to either party's workforce), or restraints or delays affecting carriers or inability or delay in obtaining supplies of adequate or suitable materials, provided that, if the event in question continues for a continuous period in excess of 60 days, the Buyer shall be entitled to give notice in writing to the Company to terminate the Contract.

## 15. GENERAL

- 15.1 Each right or remedy of the Company under the Contract is without prejudice to any other right or remedy of the Company whether under the Contract or not.
- 15.2 If any provision of the Contract is found by any court, tribunal or administrative body of competent jurisdiction to be wholly or partly illegal, invalid, void, voidable, unenforceable or unreasonable it shall to the extent of such illegality, invalidity, voidness, voidability, unenforceability or unreasonableness be deemed severable and the remaining provisions of the Contract and the remainder of such provision shall continue in full force and effect.
- 15.3 Failure or delay by the Company in enforcing or partially enforcing any provision of the Contract shall not be construed as a waiver of any of its rights under the Contract.
- 15.4 Any waiver by the Company of any breach of, or any default under, any provision of the Contract by the Buyer shall not be deemed a waiver of any subsequent breach or default and shall in no way affect the other terms of the Contract.
- 15.5 The parties to the Contract do not intend that any term of the Contract shall be enforceable by virtue of the Contracts (Rights of Third Parties) Act 1999 by any person that is not a party to it.
- 15.6 The formation, existence, construction, performance, validity and all aspects of the Contract shall be governed by English law and the parties submit to the exclusive jurisdiction of the English courts.

## 16. COMMUNICATIONS

- 16.1 All communications between the parties about the Contract shall be in writing and delivered by hand or sent by pre-paid first class post or sent by fax:
- (a) (in case of communications to the Company) to its registered office or such changed address as shall be notified to the Buyer by the Company; or
  - (b) (in the case of the communications to the Buyer) to the registered office of the addressee (if it is a company) or (in any other case) to any address of the Buyer set out in any document which forms part of the Contract or such other address as shall be notified to the Company by the Buyer.
- 16.2 Communications shall be deemed to have been received:
- (a) if sent by pre-paid first class post, two days (excluding Saturdays, Sundays and bank and public holidays) after posting (exclusive of the day of posting); or
  - (b) if delivered by hand, on the day of delivery; or
  - (c) if sent by fax on a working day prior to 4.00 pm, at the time of transmission and otherwise on the next working day.
- 16.3 Communications addressed to the Company shall be marked for the attention of the Sales Director.









## *The Architects of Silence*

*Silent Gliss is the leading global supplier of premium interior window treatments. Since 1952 we have been tirelessly committed to the development of the worlds' smoothest, quietest systems using state of the art technology.*

*Driven by customer needs, Silent Gliss offers functional and durable products. Expert technical advice coupled with installation and support services complete the offer. Silent Gliss stands for innovative, sustainable, tailor made solutions, exceptional design and first-class quality.*

**Silent Gliss Ltd.**  
Pyramid Business Park  
Poorhole Lane, Broadstairs  
Kent CT10 2PT  
United Kingdom  
T +44 1843 863571  
info@silentgliss.co.uk

**silentgliss.co.uk**